

NAN HUA PRIMARY SCHOOL
PRELIMINARY EXAMINATION 2023
PRIMARY 6

MATHEMATICS
PAPER 1
(BOOKLET A)

Total Time for Booklets A and B: 1 hour

INSTRUCTIONS TO CANDIDATES

1. Write your name and index number in the space provided.
2. Do not turn over the page until you are told to do so.
3. Follow all instructions carefully.
4. Answer all questions.
5. Shade your answers in the Optical Answer Sheet (OAS) provided.
6. The use of calculators is **NOT** allowed.

Name : _____ ()

Class : 6 _____ 6M _____

Date : 23 August 2023

Parent's Signature : _____

This booklet consists of 7 printed pages and 1 blank page.

Questions 1 to 10 carry 1 mark each. Questions 11 to 15 carry 2 marks each.
For each question, four options are given. One of them is the correct answer.
Make your choice (1, 2, 3 or 4) and shade your answer on the Optical Answer
Sheet.

(20 marks)

1 How many hundredths are there in 0.8?

(1) 0.08

(2) 0.8

(3) 8

(4) 80

2 What is the sum of all the factors of 9?

(1) 12

(2) 13

(3) 15

(4) 16

3 Express 8 km 20 m in km.

(1) 8020 m

(2) 8.002 km

(3) 8.02 km

(4) 8.2 km

4 Express $\frac{3}{8}$ as a decimal correct to 2 decimal places.

(1) 0.308

(2) 0.38

(3) 3.08

(4) 3.8

5 What is the smallest number of squares that must be shaded so that the line PQ becomes a line of symmetry?

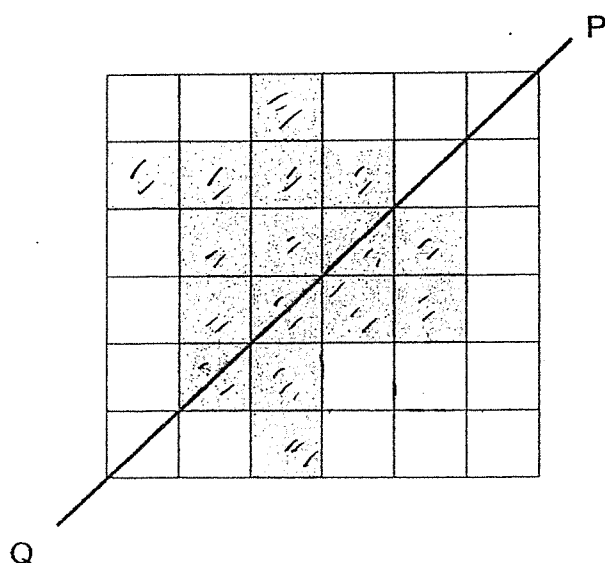

(1) 5

(2) 2

(3) 3

(4) 4

- 6 A movie started at 10.35 p.m. and ended at 1.15 a.m. How long did the movie last?

- (1) 2 h 10 min
- (2) 2 h 20 min
- (3) 2 h 40 min
- (4) 2 h 50 min

- 7 Which one of the following is not a net of the cube?

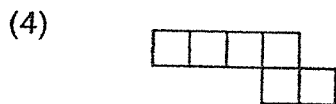
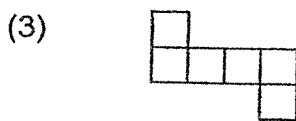
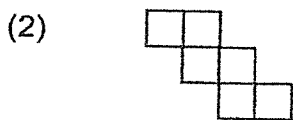
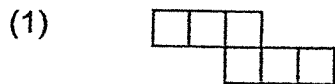

- 8 Which of the following is the most likely mass of an apple?

- (1) 20 kg
- (2) 2 kg
- (3) 200 g
- (4) 20 g

9 James paid \$20 for 40 rulers. How much did each ruler cost?

- (1) 5 cents
- (2) 2 cents
- (3) 50 cents
- (4) 20 cents

10 In the rectangle below, find the area of the shaded triangle.

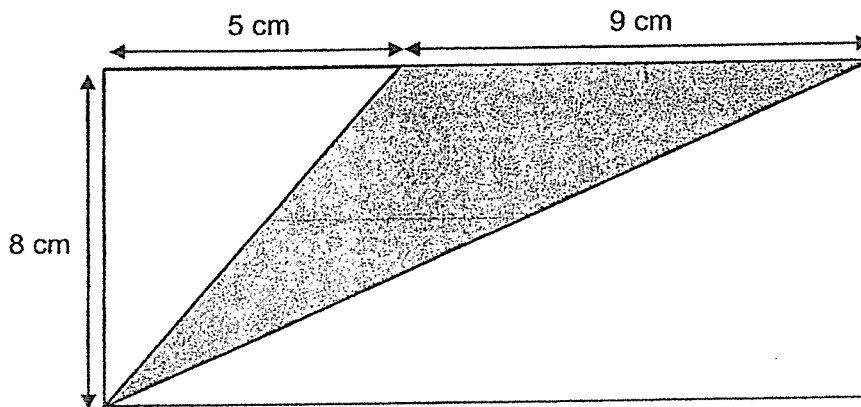

- (1) 20 cm^2
- (2) 36 cm^2
- (3) 56 cm^2
- (4) 72 cm^2

11 Two years ago, Andy was n years older than Belle.

Andy is twice her age now, how old was Belle 2 years ago?

- (1) n
- (2) $2n$
- (3) $n - 2$
- (4) $2n - 2$

- 12 The pie chart shows Lillian's expenditure last month. She spent half of what she had on food. How much did she spend on transport?

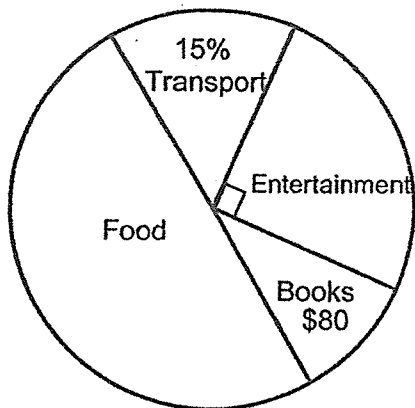

- (1) \$120
 (2) \$200
 (3) \$400
 (4) \$800
- 13 The figure is made up of 2 identical semicircles of diameter 14 cm. Find the perimeter of the figure. Take $\pi = \frac{22}{7}$

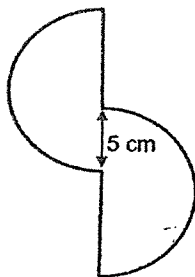

- (1) 44 cm
 (2) 62 cm
 (3) 67 cm
 (4) 72 cm

- 14 There were a total of 50 blue, red and white marbles in a box. The number of blue and red marbles was $\frac{2}{5}$ of the total number of marbles. The number of red and white marbles was $\frac{9}{10}$ of the total number of marbles. Find the number of red marbles.

- (1) 15
- (2) 20
- (3) 25
- (4) 45

- 15 In a school, 40% of the pupils are boys. 7
5% of the boys and 20% of the girls walk to school.
What percentage of the pupils in the school walk to school?

- (1) 14%
- (2) 15%
- (3) 25%
- (4) 65%

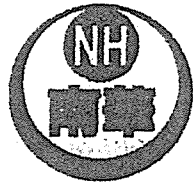

NAN HUA PRIMARY SCHOOL
PRELIMINARY EXAMINATION 2023
PRIMARY 6

MATHEMATICS
PAPER 1
(BOOKLET B)

Total Time for Booklets A and B: 1 hour

INSTRUCTIONS TO CANDIDATES

1. Write your name and index number in the space provided.
2. Do not turn over the page until you are told to do so.
3. Follow all instructions carefully.
4. Answer all questions.
5. Write your answers in this booklet.
6. The use of calculators is **NOT** allowed.

Marks Obtained

Paper 1	Booklet A		/ 45
	Booklet B		
Paper 2			/ 55
Total			/ 100

Name : _____ ()

Class : 6 _____ 6M _____

Date : 23 August 2023

Parent's Signature: _____

This booklet consists of 10 printed pages

Questions 16 to 20 carry 1 mark each. Write your answers in the spaces provided.
For questions which require units, give your answers in the units stated. (5 marks)

Do not write
in this space

16 Express 8% as a fraction. Give your answer in its simplest form.

Ans: _____

17 Round 589.02 to the nearest tenth.

Ans: _____

18 Six identical cubes are glued together to form a cuboid as shown below. Each cube has the length of 1 cm. The cuboid is then submerged fully into a pail of red paint. Find the total area of the cuboid that is painted red.

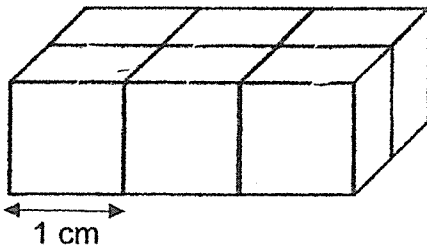

Ans: _____ cm²

19 What is the greatest possible whole number that gives 9300 when rounded to the nearest ten?

Do not write
in this space

Ans: _____

20 Give a fraction that is halfway between $\frac{1}{5}$ and $\frac{1}{3}$.

Ans : _____

(Go on to the next page)

Questions 21 to 30 carry 2 marks each. Show your working clearly and write your answers in the spaces provided. For question which require units, give your answers in the units stated. (20 marks)

Do not write in this space

- 21 The graph below shows the number of pets per household in a block of flats.

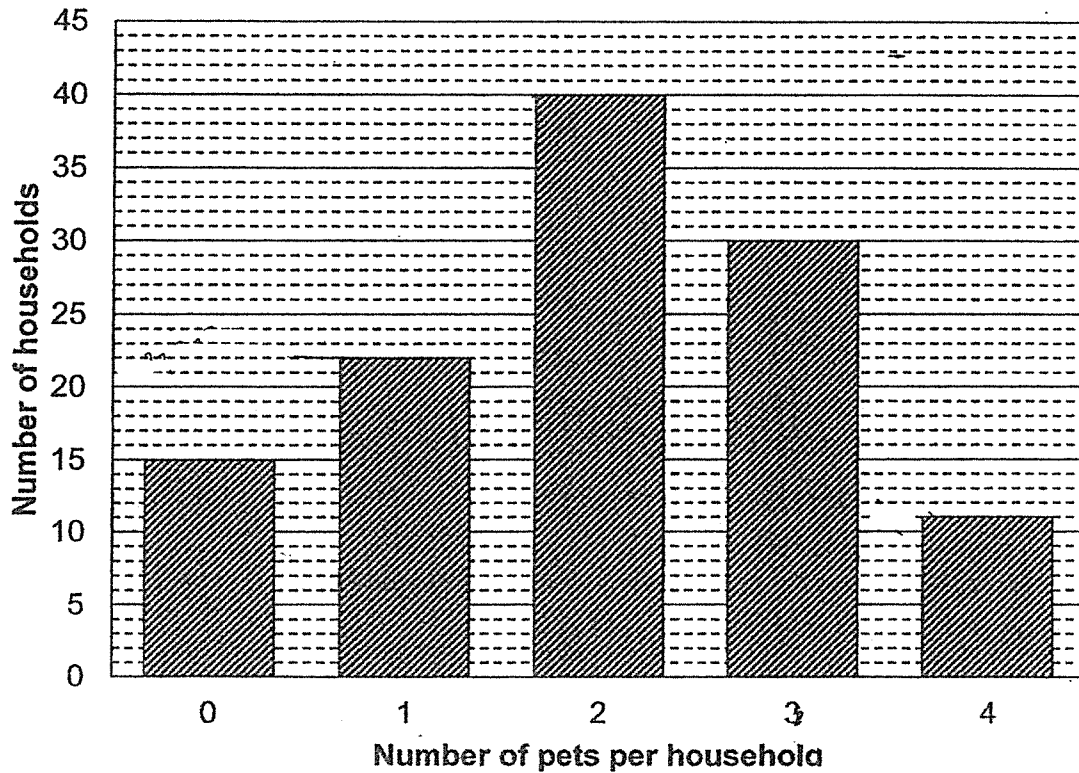

How many pets are there in this block of flats?

Ans : _____

- 22 Study the pattern below carefully. If the pattern continues, what is the 99th letter?

S Q U A R E S Q U A R E S Q U A R E
 1st 18th

Do not write
in this space

Ans: _____

- 23 The figure below is made up of triangle and a rectangle. The area of the rectangle is twice the area of the triangle. $\frac{1}{8}$ of the rectangle is shaded. What is the ratio of the shaded area to the total area of the figure?

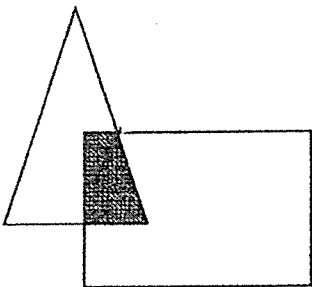

Ans: _____

(Go on to the next page)

- 24 A rectangle PQRS is folded along its diagonal PR as shown below. Given that $\angle PRS = 23^\circ$, find $\angle QRS$ after the fold.

Do not write
in this space

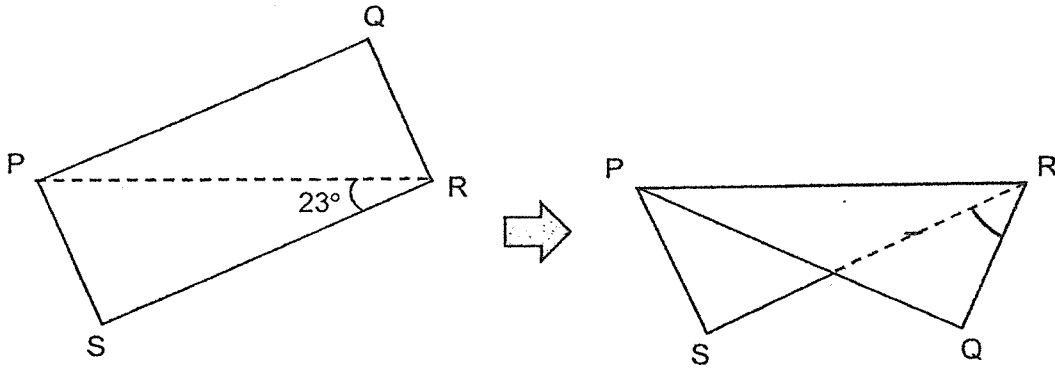

Ans : _____^o



25 In the diagram below, ABCD is a parallelogram.

CFE and DGE are straight lines.

Find $\angle BCF$.

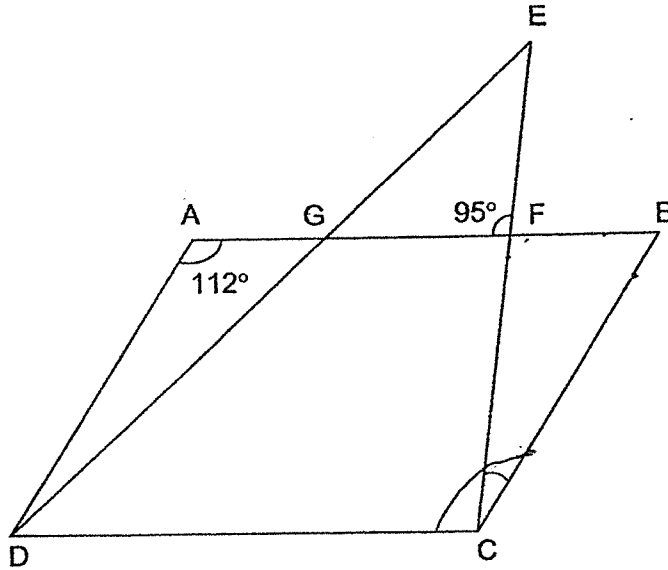

Do not write
in this space

Ans : _____ $^\circ$



(Go on to the next page)

- 26 Jack and Keith left Town X at the same time and travelled in opposite directions along a straight road. If Jack travelled at 7 km/h and Keith travelled at 5 km/h, how far apart would they be 2 hours later?

Do not write
in this space

Ans : _____ km

- 27 A group of 5 boys rented a paddle boat for 2 hours and took turns to play. At any one time, there were 3 boys paddling the boat. On average, how long did each boy play on the paddle boat?

Ans: _____ min

- 28 Two numbers X and Y are in the ratio of 3 : 7. After Y is halved and X is increased by 4, the ratio became 1 : 1. What is the original value of X?

Do not write
in this space

Ans: _____

- 29 John has just enough money to buy either 6 rulers and 3 erasers or 4 rulers and 8 erasers. He spends all the money on erasers, how many erasers can he buy?

Ans : _____

(Go on to the next page)

AEFC

30 In the figure below, ABCD is a rhombus. ~~AEFC~~ and BFD are straight lines.

Find $\angle DAE$.

Do not write in this space

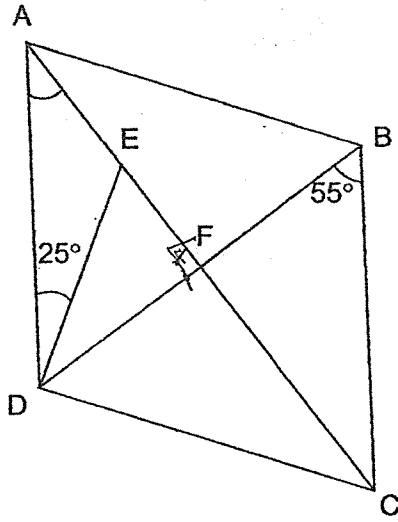

Ans : _____ °



End of Paper

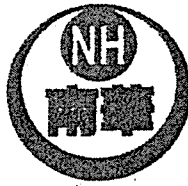

**NAN HUA PRIMARY SCHOOL
PRELIMINARY EXAMINATION 2023
PRIMARY 6**

**MATHEMATICS
Paper 2**

Time : 1 hour 30 minutes

INSTRUCTION TO CANDIDATES

1. Write your name and index number in the space provided.
2. Do not turn over the page until you are told to do so.
3. Follow all instructions carefully.
4. Answer all questions.
5. Use a dark blue or black ballpoint pen to write your answers in the space provided for each question.
6. Do not use correction fluid/tape or highlighters.
7. The use of an approved calculator is allowed.

Marks Obtained

Total	Max Mark
	55

Name : _____ ()

Class : 6 _____ / 6M _____

Date : 23 August 2023

Parent's Signature : _____

This booklet consists of 15 printed pages and 1 blank page.

Questions 1 to 5 carry 2 marks each. Show your working clearly and write your answers in the space provided. For questions which require units, give your answers in the units stated. (10 marks)

Do not write in this space

- 1 The total mass of two boys was 72.9 kg. The difference between their mass was 9.3 kg. What was the mass of the lighter boy?

Ans: _____ kg

- 2 The figure below is formed by five identical equilateral triangles. The total perimeter of the five triangles is 135 cm. What is the perimeter of the figure?

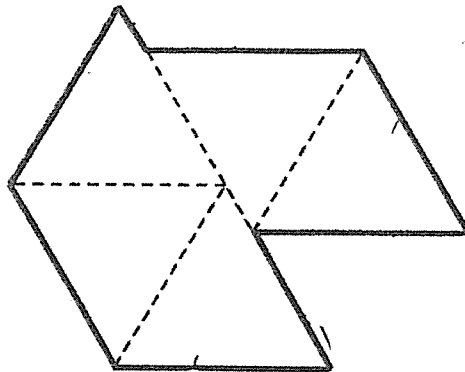

Ans: _____ cm

- 3 In the figure below, A and B are two points on a map. Point A is north of B. Point C is east of B and $\angle BAC = 50^\circ$. Draw triangle ACB by completing the figure.

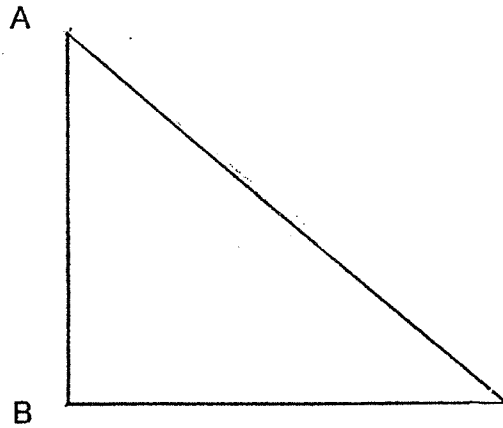

Do not write
in this space

- 4 A printing machine prints 8 pages every 5 seconds. How many pages can it print in 10 minutes?

Ans: _____

(Go on to the next page)

- 5 The square grid shows the position of points A, B, C, D, E and F.

Do not write
in this space

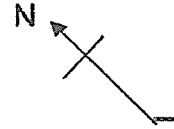
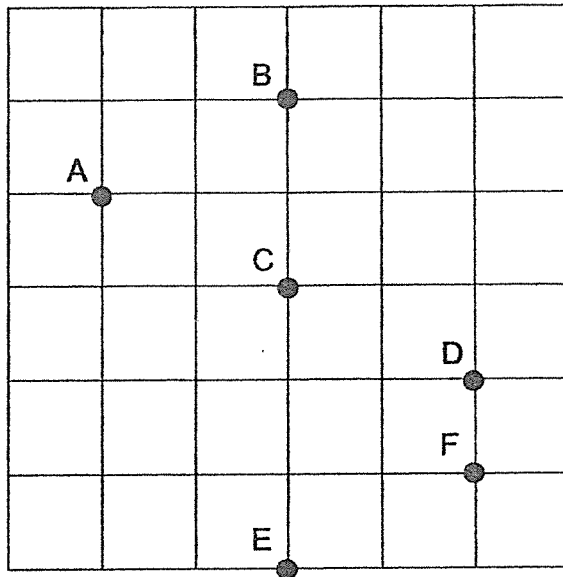

- (a) Which one of the points shown on the square grid is south of point C?

Ans: (a) Point _____

- (b) Jason stood at one of the points facing point B. After he turned 45° clockwise, he faced point D. Which point was Jason at?

Ans: (b) Point _____



For questions 6 to 17, show your working clearly and write your answers in the spaces provided. The number of marks available is shown in brackets [] at the end of each question or part-question. (45 marks)

Do not write
in this space

6 3 m of fabric was cut into shorter pieces. Each piece was $\frac{2}{5}$ m, except for the last piece which was shorter.

(a) How many $\frac{2}{5}$ m pieces were there?

Ans: (a) _____ [2]

(b) What was the length of the last piece?

Ans: (b) _____ [1]

7 In a hall, 70% of the children were boys. After 87 more children entered the hall, the number of boys increased by 20% and the number of girls increased by 50%. How many children were there in the hall in the end?

Ans: _____ [3]

(Go on to the next page)

- 8 In the figure, AFB and ADB are triangles. ABC , FEB and AED are straight lines. Given that $\angle DEB$ is 79° and $\angle DBC$ is 85° , find the value of $\angle DAB + \angle ADB + \angle EAF + \angle AFE$.

Do not write
in this space

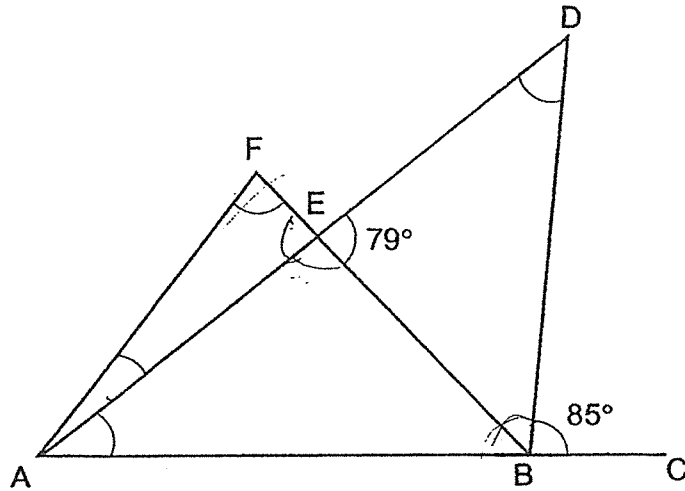

Ans: _____ [3]

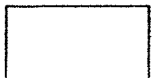

- 9 The figure below is made up of 2 identical big quarter circles and 2 identical small quarter circles. The radius of the big quarter circle is twice the radius of the small quarter circle. Find the perimeter of the figure in terms of π .

Do not write
in this space

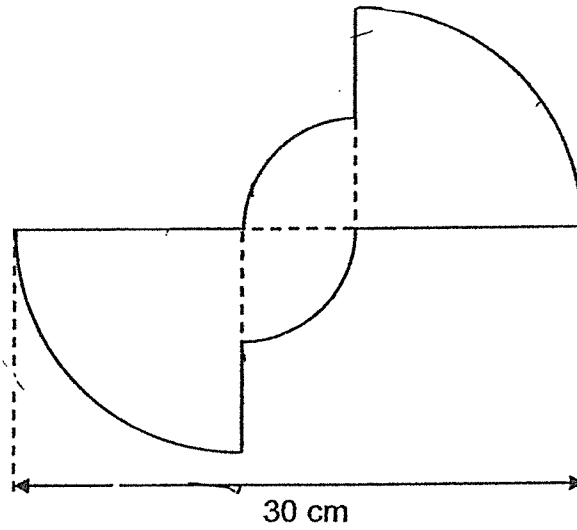

Ans: _____ [4]



- 10 The average score for a Mathematics test in a class of students was 80. Later, it was discovered that the score of one student was wrongly recorded as 48 when it should be 98 marks. After correcting this score, the average score of the class increased to 82. How many students were there in the class?

Do not write
in this space

Ans: _____ [3]

Do not write
in this space

11 Every week, Ailing saves \$2m, Bala saves $$(m + 5)$ and Carrie saves $$(3m - 2)$.

(a) Find the average weekly savings of the three children in terms of m.

(a) _____ [1]

(b) Find the average savings of the 3 children when $m = 4$.

Ans: (b) _____ [1]

(c) Each statement is either true, false or impossible to tell from the information given. Put a tick (\checkmark) to indicate your answer.

Statement	True	False	Not possible to tell
Ailing's savings is less than the average savings.			
Carrie saves the most money.			

[2]

12 The pie chart below shows the favourite ball games of a group of students.

Do not write in this space

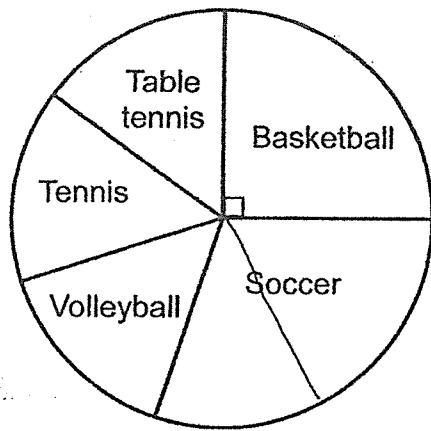

Part of the data is also represented in the bar graph below.

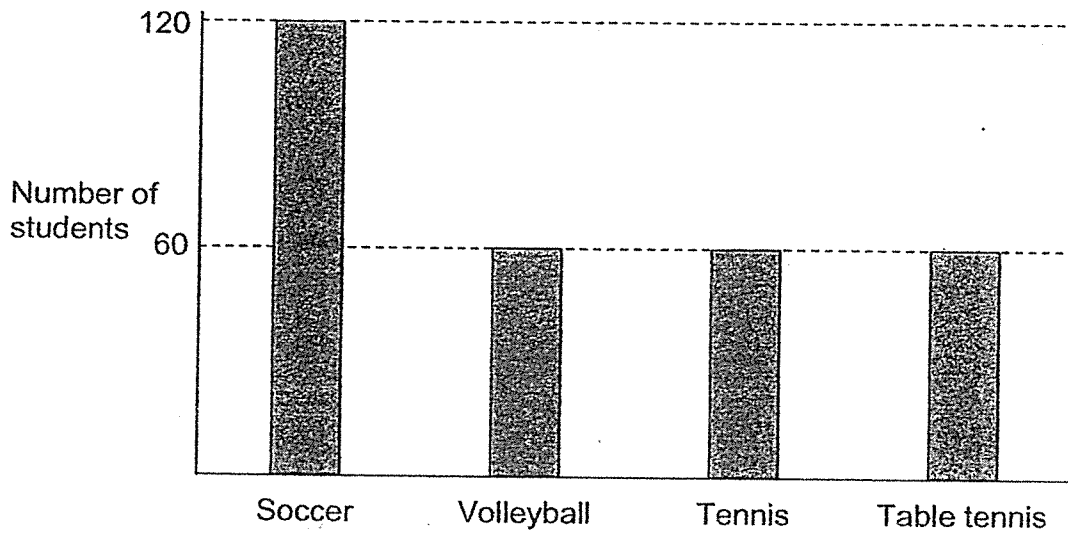

(a) What percentage of the students chose soccer as their favourite ball game?

Ans: (a) _____ [1]

(b) How many students were there in the group?

Ans: (b) _____ [2]



- 13 Tim had $\frac{2}{3}$ as much money as Peter. After Tim received \$120 from his mother and Peter used \$120, Tim had twice as much money as Peter. How much money did Tim have at first?

Do not write
in this space

Ans: _____ [3]

- 14 Look at the figures below. They are made up of shaded tiles and plain tiles.

Do not write
in this space

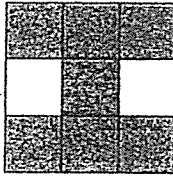

Figure 1

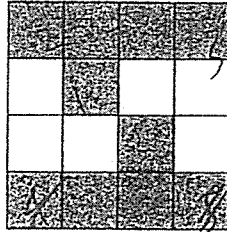

Figure 2

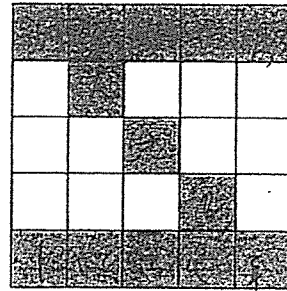

Figure 3

- (a) There are 19 shaded tiles in a figure. What is the figure number?

Ans: (a) _____ [1]

- (b) What is the total number of shaded and plain tiles in Figure 18?

Ans: (b) _____ [1]

- (c) What percentage of the total number of tiles in Figure 18 are shaded tiles?

Ans: (c) _____ [3]



- 15 The figure below is made up of a square, a quarter circle and a semicircle. The area of the square is 196 cm^2 . Find the area of the shaded parts. (Take $\pi = 3.14$)

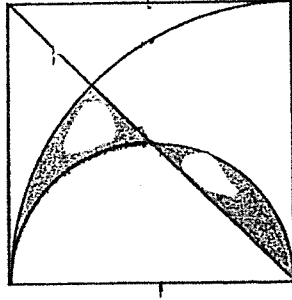

Do not write
in this space

Ans: _____ [4]

- 16 An empty rectangular tank measuring 35 cm by 20 cm by 50 cm is being filled with water from Tap A at a rate of 700 m l per minute. Tap B drains out water from the tank at 0.5 l per minute. Tap A is turned on 6 minutes before tap B.

Do not write
in this space

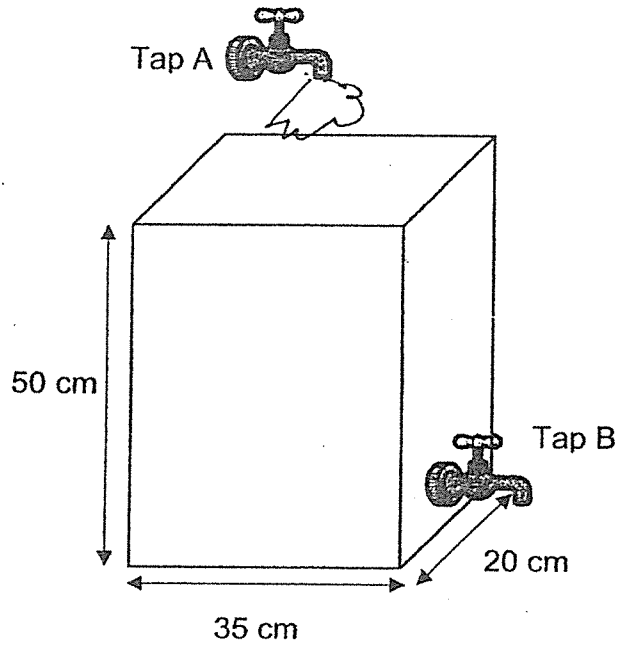

- (a) How much water was there in the tank after 6 minutes?

Ans: (a) _____ [1]

- (b) How long will it take for 60% of the tank to be filled?

Ans: (b) _____ [4]



- 17 Alice was given the same amount of pocket money every day. The line graph shows the amount of money she had left at the end of the day for a particular week.

Do not write
in this space

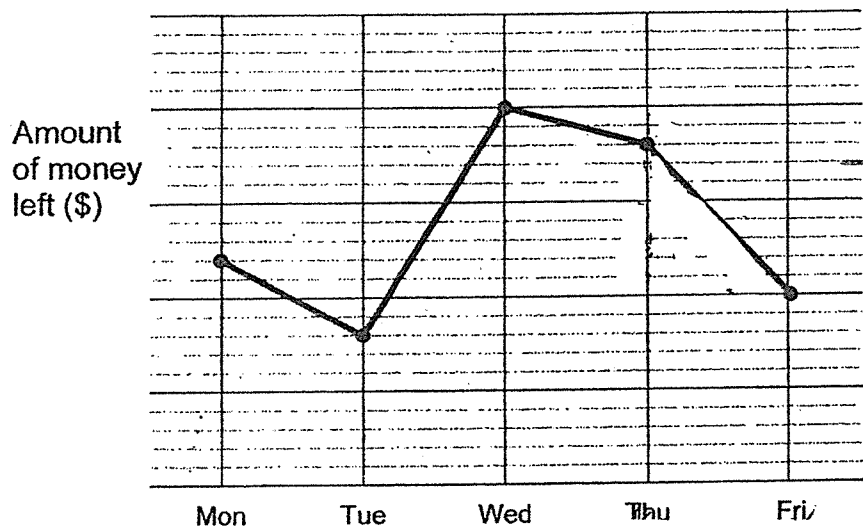

- (a) On which day did Alice spend the most money?

Ans: (a) _____ [1]

- (b) What is the percentage decrease in the amount of money left on Thursday from Wednesday?

Ans: (b) _____ [2]

- (c) Alice had \$1.60 less of the pocket money left on Friday compared to Thursday. What is the total amount of money left for the 5 days?

Ans: (c) _____ [2]

End of Paper

Nan Hua Primary School
Primary 6 Mathematics 2023 Prelims
Answer Key

Paper 1 Booklet A

Questions 1 to 10 (1 mark each)

Questions 11 to 15 (2 marks each)

No.	Answer	No.	Answer	No.	Answer
1	(4)	6	(3)	11	(3)
2	(2)	7	(4)	12	(1)
3	(3)	8	(3)	13	(2)
4	(2)	9	(3)	14	(1)
5	(1)	10	(2)	15	(1)

Paper 1 Booklet B

Questions 16 to 20 (1 mark each)

Questions 21 to 30 (2 marks each)

No.	Solution
16	$\frac{2}{25}$
17	589.0
18	22 cm ²
19	9304
20	$\frac{4}{15}$

Qn/AO	Solution	Qn/AO	Solution
21	$22 + 80 + 90 + 44$ $= 236$	26	$(2 \times 7) \text{ km} + (2 \times 5) \text{ km}$ $= 24 \text{ km}$
22	$99 \div 6 = 16 \text{ R}3$ U	27	$3 \times 120 = 360$ $360 \div 5 = 72$
23	R : T 2 : 1 8 : 4 R (shaded) : R (unshaded) 1 : 7 T (shaded) : T (unshaded) 1 : 3 Shaded : Total 1 : 7 + 3 + 1 1 : 11	28	Method 1 $0.5u = 4$ $1u = 8$ $8 \times 3 = 24$ Method 2 Before After X : Y X : Y 6 : 14 7 : 7 $7u - 6u = 1u$ $1u = 4$ $6u = 6 \times 4 = 24$
24	$90^\circ - 23^\circ = 67^\circ$ $67^\circ - 23^\circ = 44$	29	2 rulers \rightarrow 5 erasers $15 + 3 = 18$
25	$\angle \text{CFB} = 95^\circ$ $\angle \text{ABC} = 180^\circ - 112^\circ = 68^\circ$ $\angle \text{DEF} = 180^\circ - 95^\circ - 68^\circ = 17^\circ$	30	$\angle \text{DAE} = (180^\circ - 55^\circ \times 2) \div 2$ $= 35^\circ$ OR $\angle \text{DAE} = 180^\circ - 90^\circ - 55^\circ$ $= 35^\circ$

Paper 2

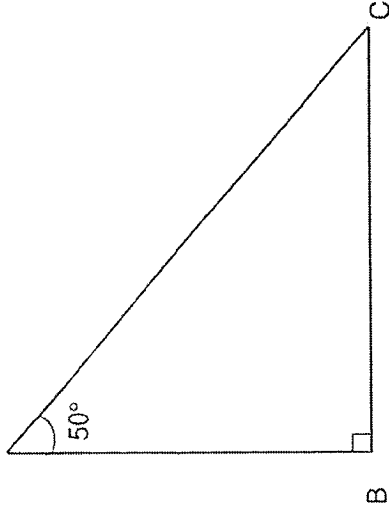
No.	Solution	No.	Solution
1	$2 \text{ units} = 72.9 - 9.3$ $= 63.6$ $1 \text{ unit} = 63.6 \div 2$ $= \underline{31.8}$	4	$60 \div 5 = 12$ $12 \times 8 = 96$ 96×10 $= \underline{960}$ <p>OR</p> $5s \rightarrow 8$ $\text{Sets of } 5s \rightarrow 600 \div 5$ $= 120$ $600s \rightarrow 120 \times 8$ $= \underline{960}$
2	$\text{Length of 1 side} = 135 \div 15$ $= 9$ $\text{Perimeter} = 9 \times 7$ $= \underline{63}$	5 (a)	F
3		(b)	E

Question 6 to 17 carry 3 to 5 marks each.

No.	Solution	No.	Solution
6	$(a) 3 + \frac{2}{5} = 3 \times \frac{5}{5} + \frac{2}{5}$ $= 7\frac{1}{5}$ <p>Ans: 7</p> $(b) \frac{1}{2} \times \frac{2}{5} m = \frac{1}{5} m$	8	$\angle ABD = 180^\circ - 85^\circ = 95^\circ$ $\angle DAB + \angle ADB = 180^\circ - 95^\circ = 85^\circ$ $\angle FEA = 79^\circ$ $\angle EAF + \angle AFE = 180^\circ - 79^\circ = 101^\circ$ $\angle DAB + \angle ADB + \angle EAF + \angle AFE = 85^\circ + 101^\circ$ $= \underline{186^\circ}$
7	$120\% \times 70\% = 84\%$ $150\% \times 30\% = 45\%$ $84\% + 45\% - 100\% = 29\%$ $29\% \rightarrow 87$ $1\% \rightarrow 87 \div 29 = 3$ $129\% \rightarrow 3 \times 129$ $= \underline{387}$ <p>OR</p> <p>B : G</p> <p>7 : 3</p> <p>Increase in boys $\rightarrow \frac{1}{5} \times 7u = 1.4u$</p> <p>Increase in boys $\rightarrow \frac{1}{2} \times 3u = 1.5u$</p> $2.9u = 87$ $1u = 87 \div 29 = 3$ $12.9u = 3 \times 129$ $= \underline{387}$	9	$5 \text{ units} = 30$ $\text{Small radius} = 30 \div 5 = 6$ $\text{Small diameter} = 12$ $\text{Big radius} = 6 \times 2 = 12$ $\text{Big diameter} = 24$ $2 \text{ big arc} = 0.5 \times \pi \times 24 = 12\pi$ $2 \text{ small arc} = 0.5 \times \pi \times 12 = 6\pi$ $\text{Perimeter of figure} = 12\pi + 6\pi + 12 + 12 + 6 + 6$ $= \underline{(18\pi + 36) \text{ cm}}$

No.	Solution	Mark	Remarks												
10	<p>Change in total = $98 - 48 = 50$ Change in average = $82 - 80 = 2$ Number of students = $50 \div 2 = \underline{25}$</p>	12	<p>(a) 5 units \rightarrow 75% 2 units \rightarrow <u>30%</u> (b) 15% \rightarrow 60 100% \rightarrow $60 \div 15 \times 100 = \underline{400}$</p>												
11	<p>(a) Total savings = $2m + m - 5 + 3m - 2 = 6m + 3$ Average = $\\$ \frac{6m+3}{3}$ or $\\$(2m+1)$ (b) $\\$(2 \times 4 + 1) = \underline{\\$9}$ (c)</p> <table border="1" style="width: 100%; border-collapse: collapse;"> <thead> <tr> <th style="width: 50%;">Statement</th> <th style="width: 20%;">True</th> <th style="width: 20%;">False</th> <th style="width: 10%;">Not possible to tell</th> </tr> </thead> <tbody> <tr> <td>Ailing's savings is less than the average savings.</td> <td style="text-align: center;">✓</td> <td></td> <td></td> </tr> <tr> <td>Carrie saves the most money.</td> <td></td> <td></td> <td style="text-align: center;">✓</td> </tr> </tbody> </table>	Statement	True	False	Not possible to tell	Ailing's savings is less than the average savings.	✓			Carrie saves the most money.			✓	13	<p>Unchanged total T : P : Total 2 : 3 : 5 6 : 9 : 15 4 units = 120 1 unit = $120 \div 4 = 30$ Tim \rightarrow $\\$30 \times 6 = \underline{\\$180}$ T : P : total 2 : 1 : 3 10 : 5 : 15</p>
Statement	True	False	Not possible to tell												
Ailing's savings is less than the average savings.	✓														
Carrie saves the most money.			✓												

No.	Solution	Mark	Remarks
14	(a) $19 - 4 = 15$ $15 \div 3 = 5$ (b) $20 \times 20 = \frac{400}{400}$ (c) No. of shaded tiles = $3 \times 18 + 4$ (M1) $= 58$ $\frac{58}{400} \times 100\%$ $= \underline{14.5\%}$ or $14\frac{1}{2}\%$	15	 $\sqrt{196} = 14$ Area of quadrant = $\frac{1}{4} \times 3.14 \times 14 \times 14$ $= 153.86$ Area of half quadrant = $153.86 \div 2 = 76.93$ Area of triangle = $\frac{1}{2} \times 14 \times 7$ $= 49$ Shaded area = $76.93 \text{ cm}^2 - 49 \text{ cm}^2$ $= \underline{27.93 \text{ cm}^2}$ OR $\sqrt{196} = 14$ Area A = $(\frac{1}{4} \times 3.14 \times 7 \times 7) - \frac{1}{2} \times 7 \times 7$ $= 13.965$ Area B = $(\frac{1}{8} \times 3.14 \times 14^2) - (\frac{1}{4} \times 3.14 \times 7^2) - \frac{1}{2} \times 7^2$ $= 76.93 - 38.465 - 24.5$ $= 13.965$ Shaded area $\rightarrow 13.965 \text{ cm}^2 + 13.965 \text{ cm}^2$ $= \underline{27.93 \text{ cm}^2}$

No.	Solution
16	<p>(a) $700 \text{ m l} \times 6 = 4200 \text{ m l} / 4200 \text{ cm}^3 / 4.2 \ell$</p> <p>(b) $60\% \times 35 \times 20 \times 50 = 21\,000$ $700 \times 6 = 4200$ $21\,000 - 4200 = 16\,800$ $700 - 500 = 200$ $16\,800 \div 200 = 84$ $84 + 6 = 90$</p> <p><u>90 min</u> or <u>1h 30min</u> or <u>1 $\frac{1}{2}$ h</u></p>
17	<p>(a) Tue / Tuesday</p> <p>(b) decrease = $20 - 18 = 2$ % decrease = $\frac{2}{20} \times 100\%$ = <u>10%</u></p> <p>(c) total units = $12 + 8 + 20 + 18 + 10 = 68$ 8 units = \$1.60 1 unit = $\\$1.60 \div 8$ = \$0.20 68 units = $\\$0.20 \times 68$ = <u>\$13.60</u></p>