

Name: \_\_\_\_\_ ( )

Class: Primary 5 \_\_\_\_\_

CHIJ ST NICHOLAS GIRLS' SCHOOL (PRIMARY)

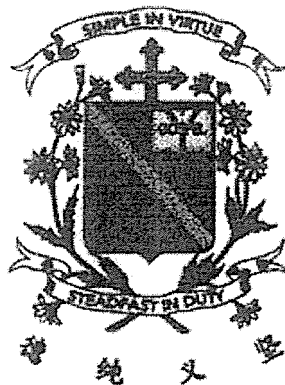

Primary 5 Mathematics

Termly Assessment 1

Paper 1

Booklet A

15 questions  
20 marks

Total Time for Booklets A and B: 1 hour

**INSTRUCTIONS TO CANDIDATES**

Do not turn over this page until you are told to do so.  
Follow all instructions carefully.  
Answer all questions.  
Write your answers in this booklet.  
The use of calculators is **NOT** allowed.

This booklet consists of 10 printed pages.

Questions 1 to 10 carry 1 mark each. Questions 11 to 15 carry 2 marks each. For each question, four options are given. One of them is the correct answer. Make your choice (1, 2, 3 or 4). Shade the correct oval (1, 2, 3, or 4) on the Optical Answer Sheet.  
(20 marks)

---

1. What is the value of the digit 8 in 680 159?

- (1) 80
- (2) 800
- (3) 8000
- (4) 80 000

2. How many quarters are there in  $3\frac{1}{4}$  ?

- (1) 7
- (2) 8
- (3) 13
- (4) 31

3. In which one of the following numbers is the digit 7 in the hundredths place?

- (1) 27.85
- (2) 75.61
- (3) 45.78
- (4) 50.07

4. One of the lines in the figure is parallel to AB. Which line is parallel to AB?

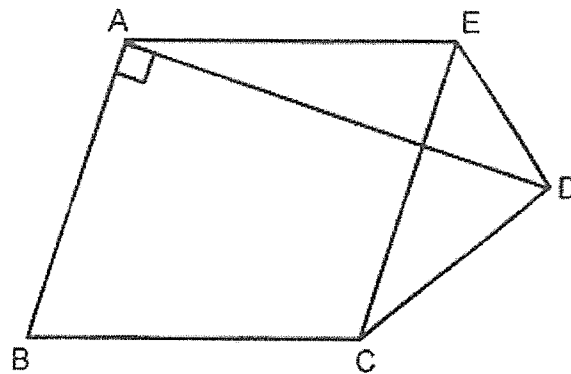

- (1) AD
- (2) AE
- (3) CD
- (4) CE

5. What is the length of the arrow as shown in the diagram below?

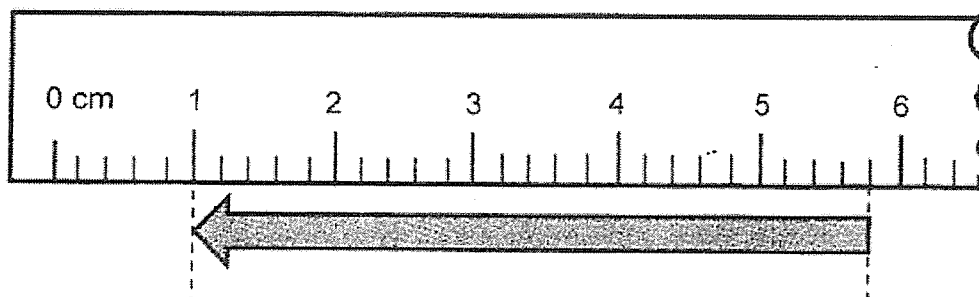

- (1) 4.4 cm
- (2) 4.8 cm
- (3) 5.4 cm
- (4) 5.8 cm

6. The bar graph shows the number of waffles of different flavours sold at Yummy Bakery in a month.

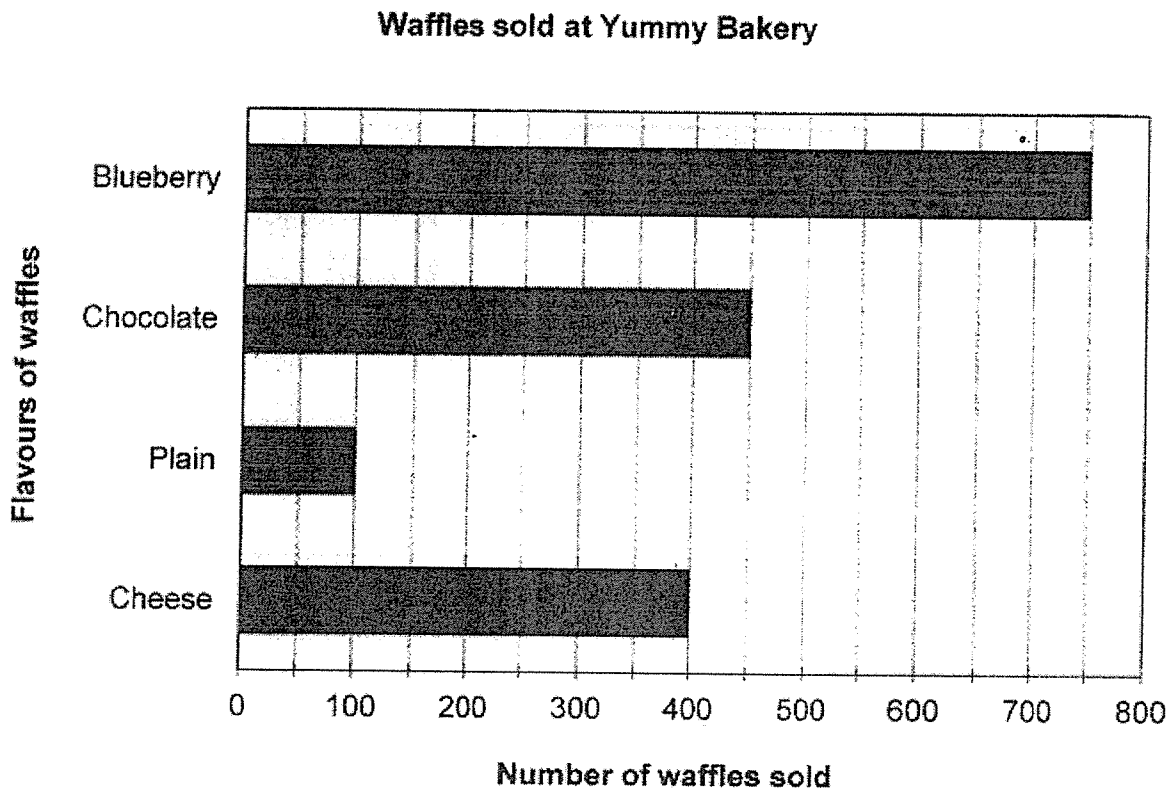

Which were the two least popular waffles sold in the month?

- (1) Cheese and Plain
- (2) Chocolate and Plain
- (3) Blueberry and Cheese
- (4) Blueberry and Chocolate

7. The bar graph shows the favourite sports voted by a number of men and women.

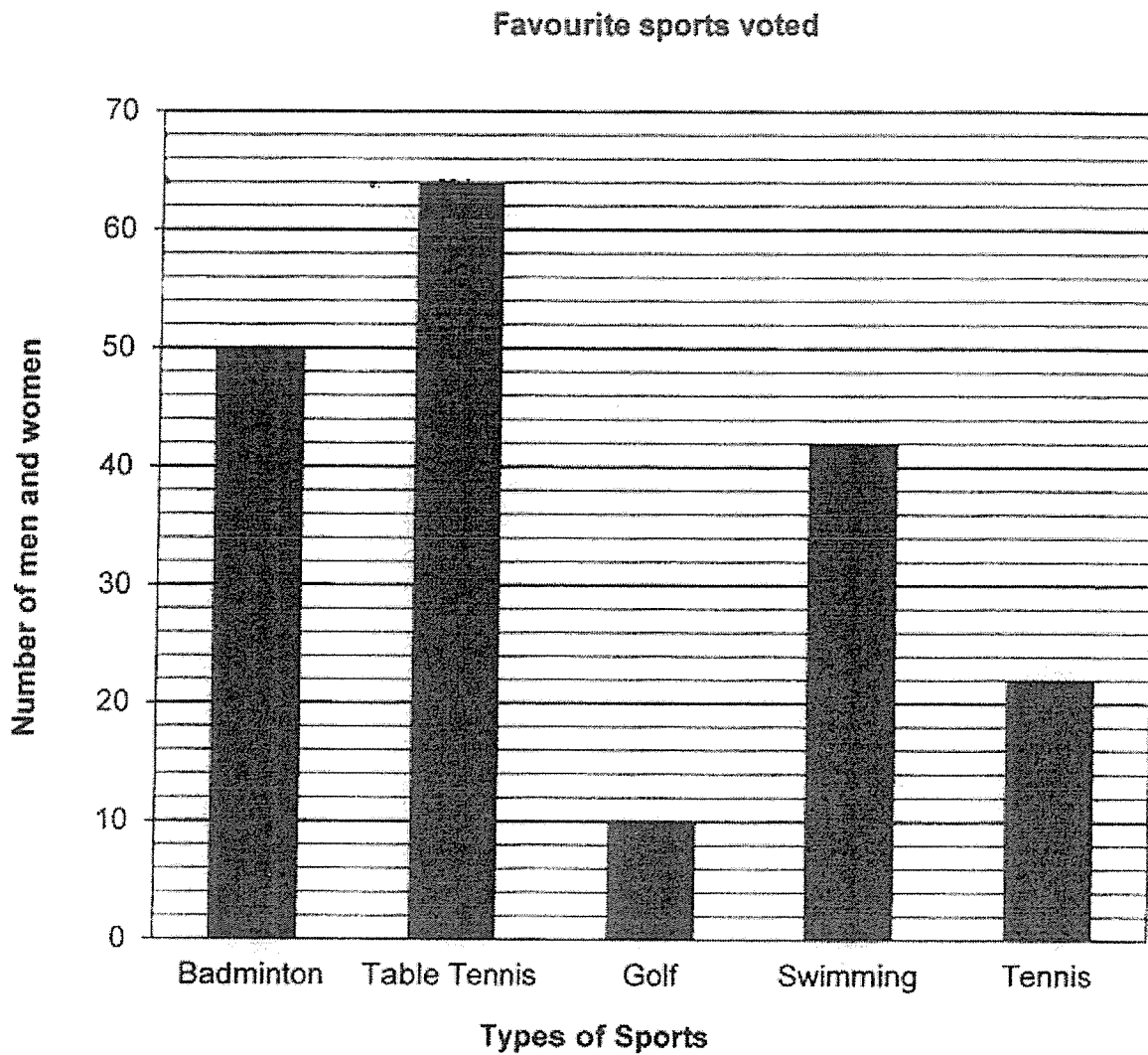

The top three favourite sports were voted by 87 men.

How many women voted for these three sports as their favourite?

- (1) 66
- (2) 69
- (3) 101
- (4) 156

8. The figure below shows a rectangle PQRS and a square ABCD. What is the area of the shaded part in the figure below?

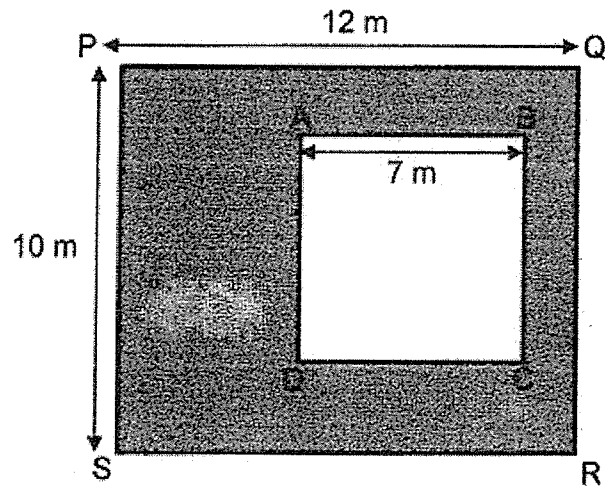

- (1)  $71 \text{ m}^2$
- (2)  $105 \text{ m}^2$
- (3)  $113 \text{ m}^2$
- (4)  $120 \text{ m}^2$

9. In the figure below, AB is a line of symmetry. How many more squares must be shaded to make the figure symmetric?

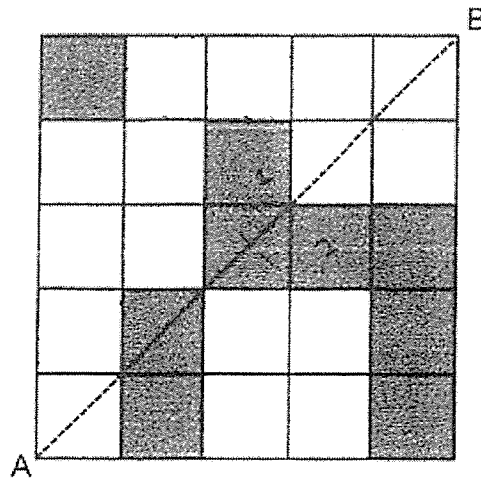

- (1) 5  
 (2) 2  
 (3) 3  
 (4) 4
10. A group of 7 girls and 9 boys shared a packet of sweets. Each of them took 5 sweets. There were 20 sweets left. Which one of the equations below shows the total number of sweets in the packet at first?
- (1)  $7 + 9 \times 5 + 20$   
 (2)  $7 + 9 \times 5 - 20$   
 (3)  $(7 + 9) \times 5 + 20$   
 (4)  $(7 \times 5) + (9 \times 5) - 20$

11. The figure below is made up of 3 identical squares and a rectangle. What is the length of BC?

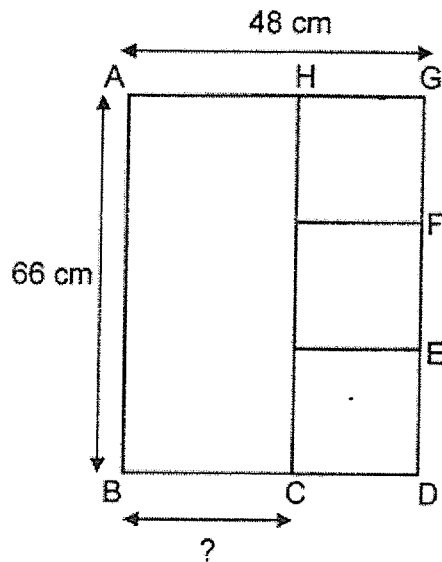

- (1) 16 cm  
 (2) 24 cm  
 (3) 26 cm  
 (4) 50 cm
12. At first, Wallace had 30 green pens. He gave  $\frac{5}{6}$  of the green pens away. Then he bought another 12 green pens. How many green pens did he have altogether in the end?
- (1) 17  
 (2) 19  
 (3) 32  
 (4) 37



13. How many white stars must be replaced by grey stars so that  $\frac{4}{5}$  of the total number of stars are grey?



- (1) 7  
(2) 11  
(3) 12  
(4) 16
14. A factory produces twice as many blouses as T-shirts daily. It produces 320 fewer T-shirts than blouses daily. How many blouses does it produce in 5 days?
- (1) 3200  
(2) 1600  
(3) 960  
(4) 640

15. Mandy wants to pack some tarts into boxes of 4, 5 or 8 with no remainder. The number of tarts she has is fewer than 50. What is the greatest possible number of tarts Mandy has?

(1) 16

(2) 20

(3) 32

(4) 40

Name: \_\_\_\_\_ ( )

Class: Primary 5 \_\_\_\_\_

CHIJ ST NICHOLAS GIRLS' SCHOOL (PRIMARY)

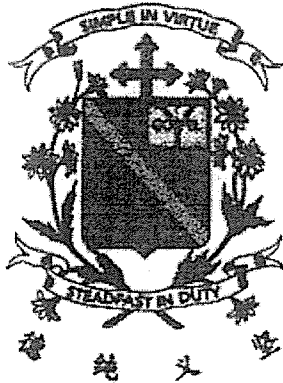

Primary 5 Mathematics

Termly Assessment 1

Paper 1

Booklet B

15 questions  
25 marks

Booklet A	20
Booklet B	25
Total (Paper 1)	45

Total Time for Booklets A and B: 1 hour

**INSTRUCTIONS TO CANDIDATES**

Do not turn over this page until you are told to do so.  
Follow all instructions carefully.  
Answer all questions.  
Write your answers in this booklet.  
The use of calculators is **NOT** allowed.

This booklet consists of 11 printed pages.

Questions 16 to 20 carry 1 mark each. Show your working clearly and write your answers in the spaces provided. For questions which require units, give your answers in the units stated. (5 marks)

Do not write in this space

16. Write three million, two hundred and fourteen thousand and fifty-six in numerals.

Ans: \_\_\_\_\_

17. Carlson spent  $\frac{1}{3}$  of his money on a book and  $\frac{1}{7}$  of his money on a burger.

What fraction of his money did Carlson spend altogether?

Ans: \_\_\_\_\_

18. Amira used 7.8 m of cloth to sew 4 identical pouches. How much cloth did she use to sew each pouch?

Do not write in this space

Ans: \_\_\_\_\_ m

19. Hafsa is standing at point Y facing south-east. How many degrees will she need to turn in a clockwise direction to face west?

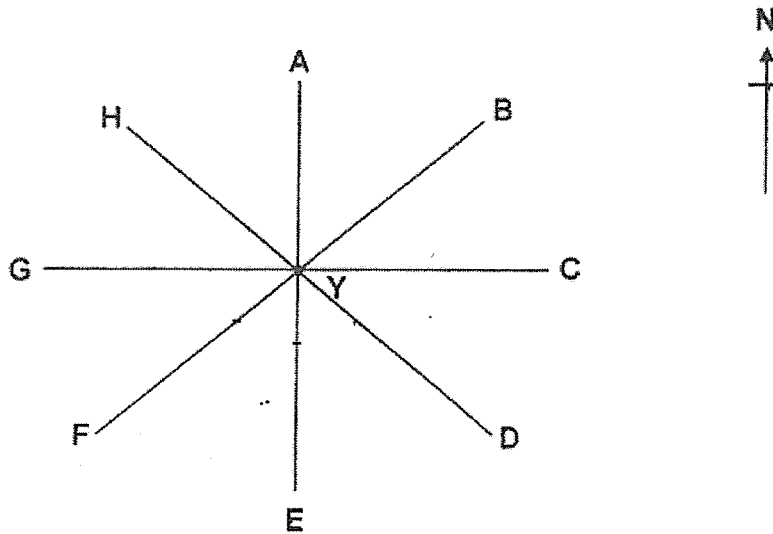

Ans: \_\_\_\_\_ °

3

MARKS:

20. Aini took 45 min to travel from home to the shopping centre.  
She reached the shopping centre at 1.30 p.m.  
At what time did she leave home?

Do not write  
in this space

Ans: \_\_\_\_\_ p.m.

Questions 21 to 30 carry 2 mark each. Show your working clearly and write your answers in the spaces provided. For questions which require units, give your answers in the units stated. (20 marks)

Do not write in this space

21. Meifang's mass is 53.4 kg when rounded to 1 decimal place. What is her greatest possible mass? Give your answer to 2 decimal places.

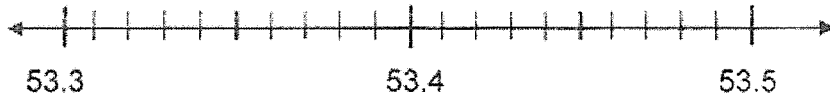

Ans: \_\_\_\_\_ kg

22. Rhean had some beads. She gave 157 beads to Shirlyn and 98 beads to Jacy. In the end, she had 254 beads. How many beads did Rhean have at first?

Ans: \_\_\_\_\_

23. 4 mangoes and 3 watermelons cost \$54.  
3 watermelons cost as much as 2 mangoes.  
Find the cost of a watermelon.

Do not write  
in this space

Ans: \$ \_\_\_\_\_

24. Brady had a container filled with 8 ℓ of water.  
He poured  $\frac{2}{5}$  ℓ into Bottle A and  $\frac{3}{10}$  ℓ into Bottle B.

How much water was left in the container?

Leave your answer as a mixed number in the simplest form.

Ans: \_\_\_\_\_ ℓ



Do not write  
in this space

25. The figure below shows a rectangle ABCD. Find  $\angle y$ .

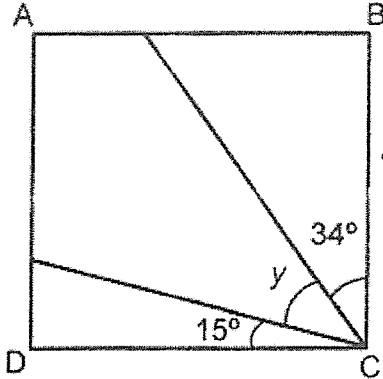

Ans: \_\_\_\_\_°

7

MARKS:

26. The table shows the mass of recycled items collected by five classes.

Do not write  
in this space

Class	Mass of recycled items collected (kg)
5A	29
5B	33
5C	12
5D	26
5E	48

- (i) Find the difference between the mass of recycled items collected by Class 5A and Class 5C.

Ans: \_\_\_\_\_ kg

- (ii) Which 2 classes collected a total of more than 80 kg of recycled items?

Ans: Class 5 \_\_\_\_\_ and Class 5 \_\_\_\_\_

27. Mrs Yoong sold curry puffs at Makan-licious Cafe. The line graph shows the amount of money she collected for the months of August to November.

Do not write  
in this space

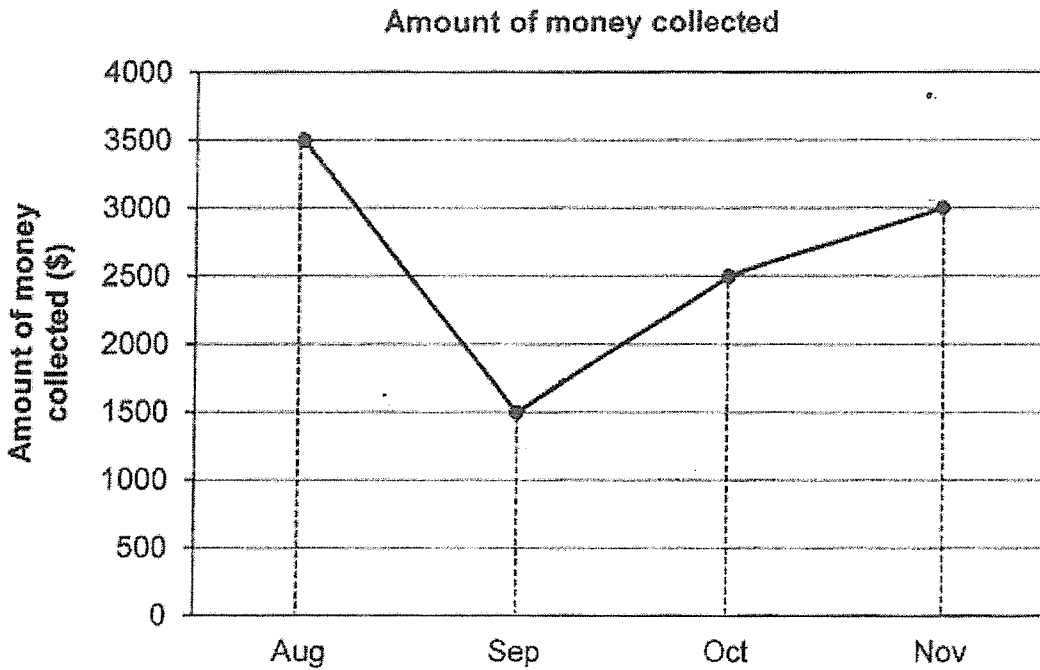

Mrs Yoong collected a total amount of \$15 500 from August to December.  
How much money did she collect in December?

Ans: \$ \_\_\_\_\_

--

28. The figure below shows a square. The perimeter of the shaded part is 32 cm. Find the area of the square.

Do not write in this space

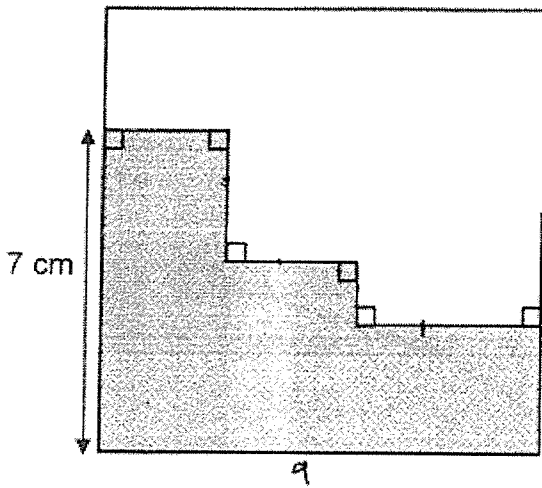

Ans: \_\_\_\_\_ cm<sup>2</sup>

29. There were some sweets in a box. Hillary took out  $\frac{3}{8}$  of the sweets on Monday and another 47 sweets on Tuesday. There were 33 sweets left in the box. How many sweets were there in the box at first?

Ans: \_\_\_\_\_

30. Wynn bought 56 pencils. The pencils were priced at 40¢ each and in a box of 6 at \$2 per box. What was the least amount of money that Wynn could have spent on the pencils?

Do not write  
in this space

Ans: \$ \_\_\_\_\_

End of Paper



SCHOOL : CHIJ ST NICHOLA GIRLS' PRIMARY SCHOOL  
 LEVEL : PRIMARY 5  
 SUBJECT : MATH  
 TERM : TERM 1 ASSESSMENT 1

PAPER 1 BOOKLET A

Q 1	Q2	Q3	Q4	Q5	Q6	Q7	Q8	Q9	Q10
4	3	4	4	2	1	2	1	3	3

Q 11	Q12	Q13	Q14	Q15
3	1	2	1	4

PAPER 1 BOOKLET B

Q16)	3214056
Q17)	$\frac{10}{21}$
Q18)	1.95m
Q19)	135°
Q20)	12.45 p.m.
Q21)	53.44 ≈ 53.4 Ans: 53.44 kg
Q22)	157 + 98 = 225 254 + 255 = 509 Ans: 509
Q23)	Monitor: \$6 x 3 = \$18 \$18 ÷ 2 = \$9 \$9 x 4 = \$36 \$36 + \$18 = \$54 4 Monitors + 3 Watermelons → \$54 \$54 ÷ 18 = \$3 \$3 x 2 = \$6 Ans: \$6
Q24)	$8 - \frac{4}{10} - \frac{3}{10} = \frac{80}{10} - \frac{4}{10} - \frac{3}{10}$

	$= \frac{73}{10}$ $= 7 \frac{3}{10}$ <p>Ans: <math>7 \frac{3}{10} \ell</math></p>
Q25)	$90 - 15 - 34 = 41$ <p>Ans: 41°</p>
Q26)	<p>i) <math>29 - 12 = 17</math>          Ans: 17kg</p> <p>ii) <math>48 + 33 = 81</math>          Ans: Class 5E and Class 5B</p>
Q27)	$3500 + 1500 + 2500 + 3000 = 10500$ $15500 - 10500 = 5000$ <p>Ans: \$5000</p>
Q28)	$32 - 7 - 7 = 18$ $18 \div 2 = 9$ $9 \times 9 = 81$ <p>Ans: 81 cm<sup>2</sup></p>
Q29)	$47 + 33 = 80$ $80 \div 5 = 16$ $16 \times 18 = 128$
Q30)	$56 \div 6 = 9$ Remainder 2 $9 \times \$2 = \$18$ $40 \text{ cents} \times 2 = 80 \text{ cents}$ $\$18 + 80 \text{ cents} = \$18.80$ <p>Ans: \$18.80</p>