



RED SWASTIKA SCHOOL

2023 END OF YEAR EXAMINATION

MATHEMATICS PAPER 1

Name : _____ ()

Class : Primary 5 / _____

Date : 31 October 2023

BOOKLET A

15 Questions

20 Marks

Duration of Paper 1 (Booklets A & B): 1 hour

Note:

1. Do not open this Booklet until you are told to do so.
2. Read carefully the instructions given at the beginning of each part of the Booklet.
3. Do not waste time. If a question is difficult for you, go on to the next one.
4. Check your answers thoroughly and make sure you attempt every question.
5. In this booklet, you should have the following:
 - (a) Page 1 to Page 5
 - (b) Questions 1 to 15
6. You are not allowed to use a calculator.

Questions 1 to 10 carry 1 mark each. Questions 11 to 15 carry 2 marks each. For each question, four options are given. One of them is the correct answer. Make your choice (1, 2, 3 or 4). Shade the correct oval (1, 2, 3 or 4) on the Optical Answer Sheet. (20 marks)

1 $30\,000 + 4000 + 500 + 6 = \underline{\hspace{2cm}}$.

- (1) 34 560
- (2) 34 506
- (3) 34 056
- (4) 30 456

2 What is the missing number in the number pattern below?

91, 73, 55, ?, 19

- (1) 18
- (2) 36
- (3) 37
- (4) 47

3 What fraction of the hearts are shaded?

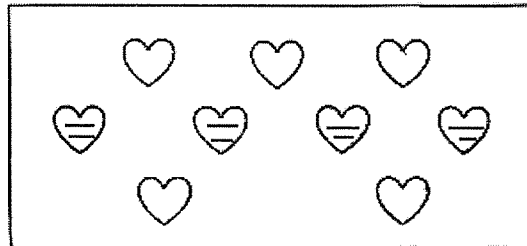

- (1) $\frac{4}{9}$
- (2) $\frac{5}{9}$
- (3) $\frac{1}{2}$
- (4) $\frac{4}{5}$

4 Find the value of $\frac{2}{3} + \frac{1}{4}$

(1) $\frac{1}{4}$

(2) $\frac{3}{7}$

(3) $\frac{5}{12}$

(4) $\frac{11}{12}$

5 Find the value of $\frac{3}{5} \times \frac{1}{2}$

(1) $\frac{3}{100}$

(2) $\frac{3}{10}$

(3) $\frac{30}{10}$

(4) $\frac{10}{3}$

6 Express $2\frac{1}{20}$ as a decimal.

(1) 2.1

(2) 2.5

(3) 2.05

(4) 2.12

7 Round 3.785 to 2 decimal places.

(1) 3.70

(2) 3.78

(3) 3.79

(4) 3.80

8 A machine takes 3 min to print 4 posters.
At the same rate, how long will it take to print 24 posters?

- (1) 6 min
- (2) 8 min
- (3) 12 min
- (4) 18 min

9 In a basket, there are 5 pears, 20 apples and 10 mangoes.
What is the ratio of the number of pears to the total number of apples and mangoes in the basket?

- (1) 1 : 2
- (2) 1 : 4
- (3) 1 : 5
- (4) 1 : 6

10 The figure shows a right-angled triangle.

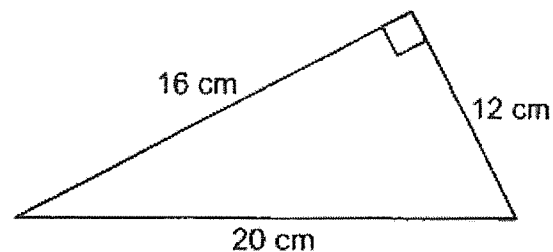

Find the area of the triangle.

- (1) 192 cm^2
- (2) 160 cm^2
- (3) 120 cm^2
- (4) 96 cm^2

- 11 In the square grid, which of the following lines, when drawn, is parallel to RS?

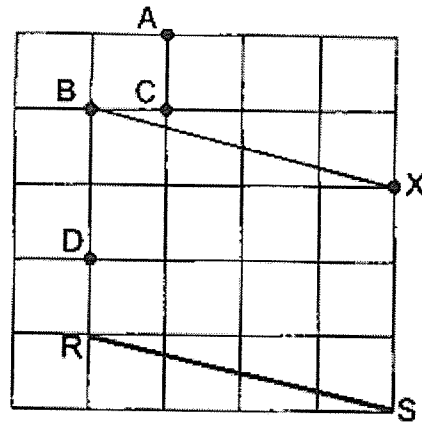

- (1) AX
(2) BX
(3) AR
(4) CR
- 12 At first, Ali was facing east. He then turned 135° anti-clockwise. What direction did Ali face in the end?

- (1) North-East
(2) North-West
(3) South-East
(4) South-West

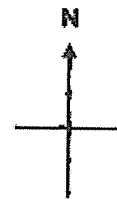

- 13 There are 240 adults and 60 children at a concert. What percentage of the people at the concert are children?

- (1) 20%
(2) 25%
(3) 60%
(4) 80%

- 14 The figure shows a rectangular glass box partly filled with unit cubes. How many additional cubes are needed to fill the glass box completely?

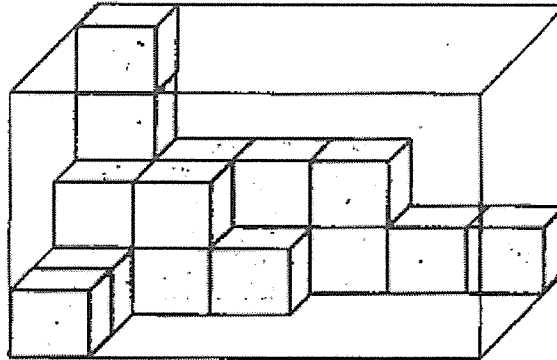

- (1) 14
(2) 19
(3) 77
(4) 96
- 15 Amy has twice as many \$20 notes as \$50 notes in a box. The total value of the money in the box is \$6300. How many \$20 notes are there in the box?
- (1) 140
(2) 180
(3) 210
(4) 315



RED SWASTIKA SCHOOL

2023 END OF YEAR EXAMINATION

MATHEMATICS PAPER 1

Name : _____ ()

Class : Primary 5 / _____

Date : 31 October 2023

BOOKLET B

15 Questions
25 Marks

In this booklet, you should have the following:

- (a) Page 6 to Page 12
- (b) Questions 16 to 30

MARKS

	OBTAINED	POSSIBLE
BOOKLET A		20
BOOKLET B		25
TOTAL		45

Parent's Signature : _____

Questions 16 to 20 carry 1 mark each. Write your answers in the spaces provided. For questions which require units, give your answers in the units stated. (5 marks)

16 Round 67 483 to the nearest hundred.

Ans: _____

17 Find the value of 400×17

Ans: _____

18 What is the value of $40 - (3 + 13) \div 4 \times 2$?

Ans: _____

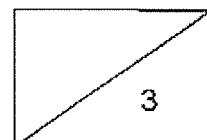

19 Write down all the common multiples of 6 and 8 that are smaller than 70.

Ans: _____

20 Find the value of $\frac{2}{9} \times 4$

Ans: _____

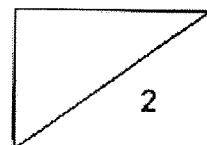

Questions 21 to 30 carry 2 marks each. Show your workings clearly in the space provided for each question and write your answers in the spaces provided. For questions which require units, give your answers in the units stated.

(20 marks)

-
- 21 Mdm Siti had 1.03 l of oil at first. She used 650 ml of it.
How many litres of oil was left?

Ans: _____ l

-
- 22 The length of Ribbon A is 9 cm. The length of Ribbon B is 5 cm longer than Ribbon A. Find the ratio of the length of Ribbon B to the length of Ribbon A.

Ans: _____

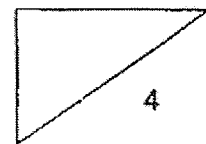

- 23 In the figure below, ABCD is a rectangle. $\angle BYX = 56^\circ$. Find $\angle BXY$.

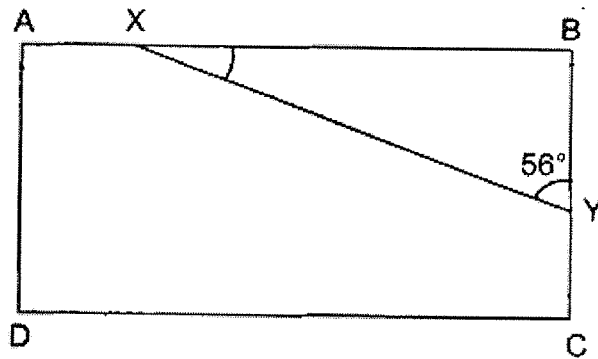

Ans: _____^o

- 24 The figure shows squares A, B and C.

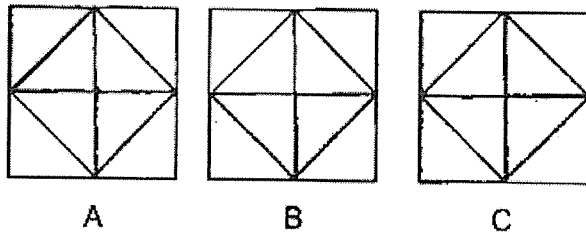

Name the square(s) with a line of symmetry.

Ans: _____

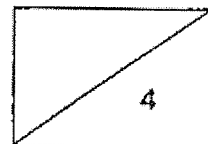

- 25 The sum of 4 numbers is 680. One of the numbers is 65.
What is the average of the other 3 numbers?

Ans: _____

- 26 A store rewards customers with 6 points for every \$50 spent. Mrs Tan spent \$240 at the store. What is the total number of points Mrs Tan receives from the store?

Ans: _____

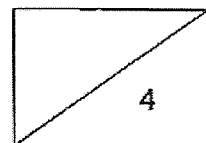

- 27 There are 600 people at a concert. 45% of the people are children, 30% of the people are women and the rest are men. How many men are there?

Ans: _____

-
- 28 The table shows the number of cups of bubble tea each person bought at a Charity Fair.

Number of cups of bubble tea each person bought	1	2	3	4
Number of people	40	20	15	5

How much money was collected if each cup of bubble tea was sold at \$6 per cup?

Ans: \$ _____

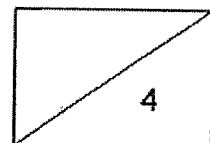

- 29 $\frac{5}{8}$ of students in a class wear spectacles. $\frac{3}{5}$ of those who wear spectacles are girls. 15 girls wear spectacles. More than half of the students are girls. What is the smallest possible number of girls who do not wear spectacles?

Ans: _____

- 30 In the figure, ABCD is a rectangle. CE is twice of ED. The area of the shaded parts is 120 cm^2 . Find the area of triangle DEF.

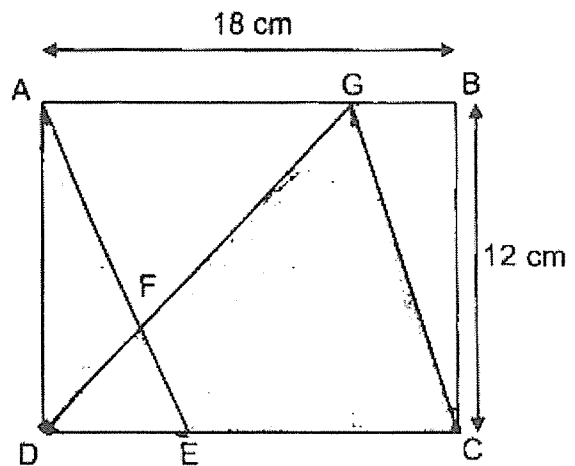

Ans: _____ cm^2

END OF PAPER

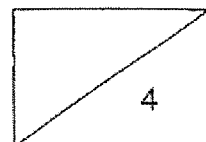



RED SWASTIKA SCHOOL

RED SWASTIKA SCHOOL

2023 END OF YEAR EXAMINATION

MATHEMATICS PAPER 2

Name : _____ ()

Class : Primary 5 / _____

Date : 31 October 2023

17 Questions

55 Marks

Duration of Paper 2: 1 hour 30 minutes

Note:

1. Do not open this Booklet until you are told to do so.
2. Read carefully the instructions given at the beginning of each part of the Booklet.
3. Do not waste time. If a question is difficult for you, go on to the next one.
4. Check your answers thoroughly and make sure you attempt every question.
5. In this paper, you should have the following:
 - (a) Page 1 to Page 13
 - (b) Questions 1 to 17
6. You are allowed to use a calculator.

MARKS

	OBTAINED	POSSIBLE
PAPER 1		45
PAPER 2		55
TOTAL		100

Parent's Signature : _____

Questions 1 to 5 carry 2 marks each. Show your workings clearly in the space below each question and write your answers in the spaces provided. For questions which require units, give your answers in the units stated.

(10 marks)

1 Use all the digits 3, 5, 9, 0 to form

a) the smallest 4-digit odd number.

Ans: (a) _____

b) the number closest to 5000.

Ans: (b) _____

2 Lena bought 1.4 kg of tomatoes. How much did she pay?

80 ¢ per 100 g

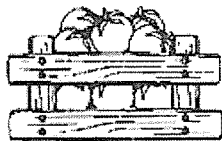

Ans: \$ _____

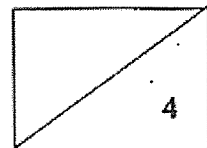

- 3 In the figure, BCDE is a rhombus. AB is a straight line. $\angle AED = 128^\circ$. Find $\angle BCD$.

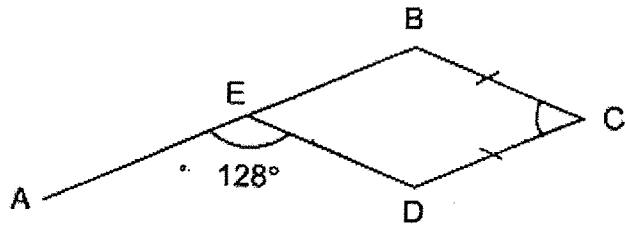

Ans: _____

- 4 Min Yi had twice as many books as James. She gave 73 books to James. After that, Min Yi had 154 books more than James. How many books did Min Yi have at first?

Ans: _____

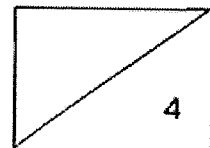

- 5 Ahmad has two sticks, A and B. The length of A is 12 cm longer than the length of B.

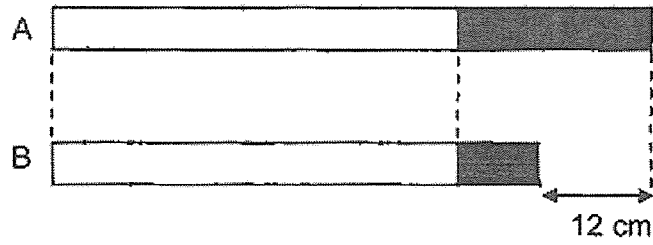

$\frac{1}{3}$ of A and $\frac{1}{6}$ of B are painted black.

What is the total length of sticks A and B?

Ans: _____ cm

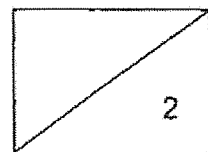

For Questions 6 to 17, show your workings clearly in the space below each question and write your answers in the spaces provided. The number of marks available is shown in brackets [] at the end of each question or part-question.

(45 marks)

- 6 The table shows the rate of charges for each overdue book borrowed from a library.

For the first 5 days	30¢ per day
After the 5th day	60¢ per day

Li Wei borrowed a book from the library which was overdue when he returned it. He paid a total of \$6.30 for the overdue book. How many days was it overdue?

Ans: _____ [3]

- 7 The ratio of Ali's age to his father's age is 1 : 4 now. In 5 years' time, their total age will be 70. How old is Ali now?

Ans: _____ [3]

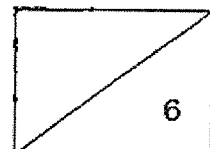

- 8 Mr Tan paid \$151.20 for an equal number of pens and highlighters. Each pen cost \$1.20. Each highlighter cost \$1.80 more than a pen. How many pens did he buy?

Ans: _____ [3]

- 9 In the diagram, UVW is a triangle. VYX and UYZ are straight lines. $UY = YZ$, $VZ = ZW$ and WX is twice of XU . What is the area of the shaded part $WXYZ$?

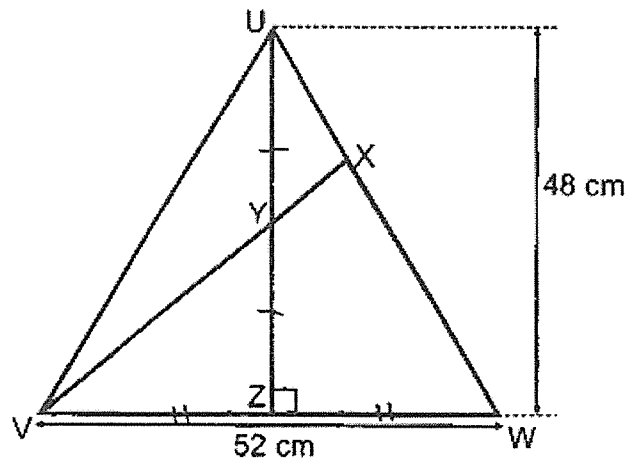

Ans: _____ [3]

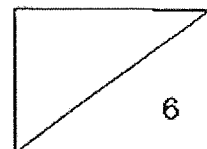

10 The square grid shows the side PQ of square PQRS and side AB of rectangle ABCD.

a) Complete square PQRS by drawing 3 more lines. [1]

b) The perimeter of rectangle ABCD is three times the perimeter of square PQRS. Complete rectangle ABCD by drawing 3 more lines. [2]

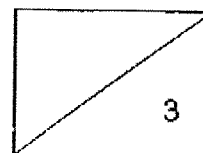
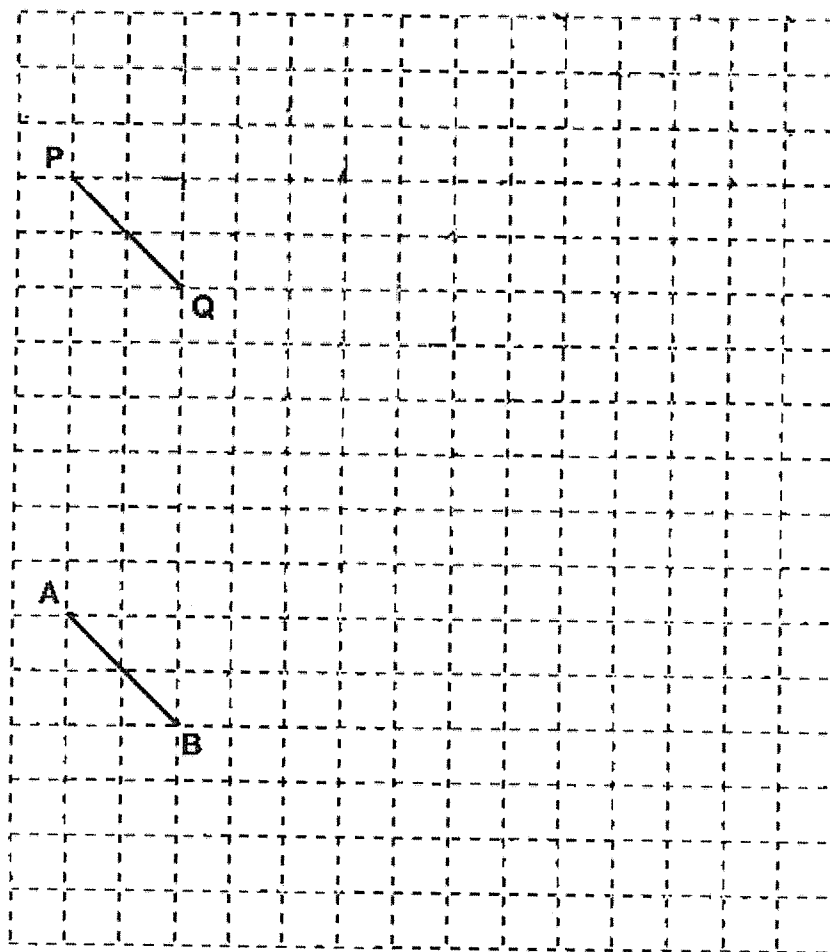

- 11 In the figure, ABCD is a rectangular piece of paper. It is folded as shown below. $\angle HJE = 67^\circ$ and $\angle FEG = 46^\circ$.

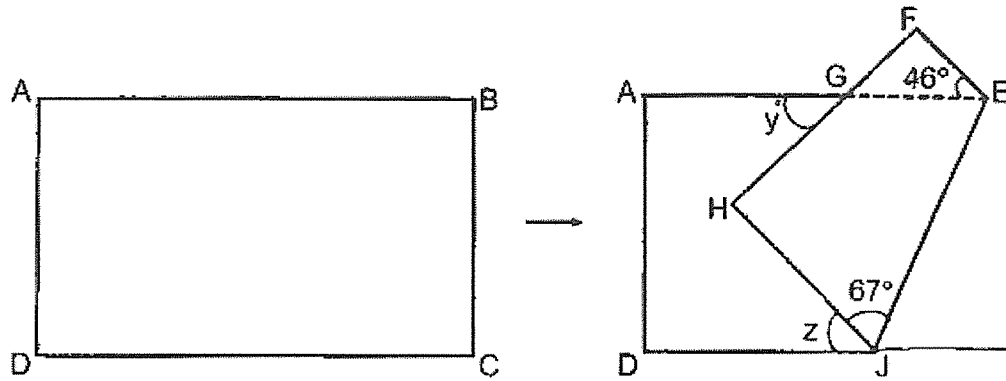

- a) Find $\angle y$.

Ans: (a) _____ [2]

- b) Find $\angle z$.

Ans: (b) _____ [2]

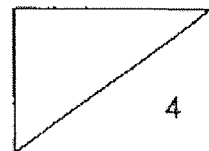

- 12 The graphs shows the total number of cards machines A and B printed from the start. Both machines started printing at the same time. Both machines did not change their rates of printing throughout.

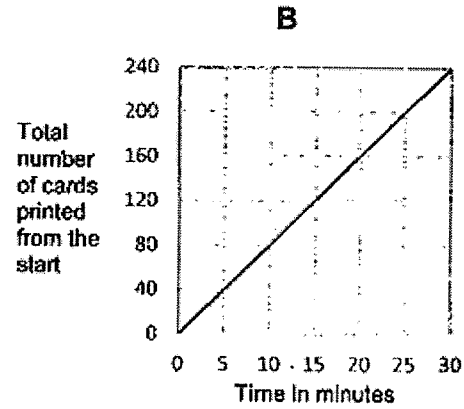
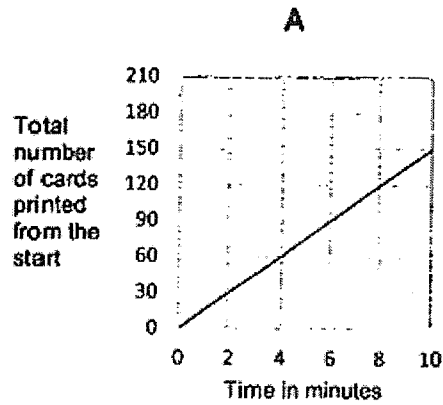

- a) How many more cards did machine A print than machine B in 10 minutes?

Ans: (a) _____ [1]

- b) How long will it take for both machines to print 2760 cards together?

Ans: (b) _____ [3]

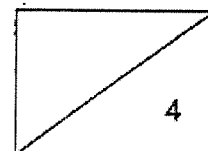

- 13 Joyce received a weekly allowance of \$50 from her mother. At the end of the week, she saved up the amount that she did not spend. The bar graph below shows her weekly savings.

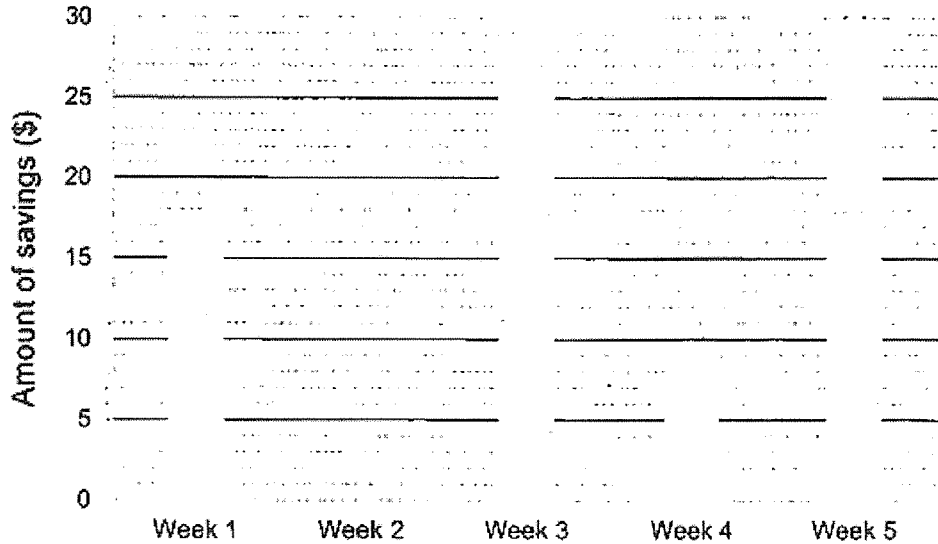

- (a) In which week did she spend the most?

Ans: (a) Week _____ [1]

- (b) Find her average weekly spending.

Ans: (b) _____ [3]

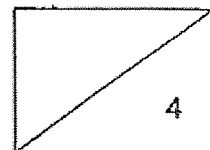

- 14 Yi Xin received the same number of coins from her mother every day for 60 days. Each coin was either a 10¢ or a 50¢ coin. Yi Xin gave her younger sister two 50¢ coins every 5 days. The total number of coins Yi Xin had left after 60 days was 216 and the total value of these coins was \$96.

a) How many coins did Yi Xin receive from her mother each day?

Ans: (a) _____ [2]

(b) How many of the coins Yi Xin had left after 60 days were 50¢ coins?

Ans: (b) _____ [2]

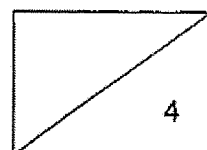

15 There were 100 red beads, 40 green beads and 70 blue beads in a box.

(a) Dinah wanted to use some beads to make a bracelet.

If $\frac{1}{2}$ of the beads in the bracelet were red, $\frac{1}{4}$ of the remainder were green and 12 beads were blue, how many beads would she need to make the bracelet?

Ans: (a) _____ [2]

(b) Using the original number of beads in the box, if Dinah wanted to make bracelets of a different pattern using 15 red beads, 5 green beads and 12 blue beads for each bracelet, how many of such bracelets can she make at most?

Ans: (b) _____ [2]

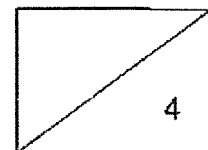

- 16 At ABC Bakery, doughnuts are sold at \$1.50 each. It is having the following promotion now.



SPECIAL OFFER !

For every 6 doughnuts, get 5% discount.

For every 10 doughnuts, get 8% discount plus 1 FREE doughnut.

- (a) Mrs Chan bought 6 doughnuts. How much did she pay?

Ans: (a) _____ [2]

- (b) Mr Lim wanted to get 35 doughnuts. What was the least amount that he needed to pay for them?

Ans: (b) _____ [3]

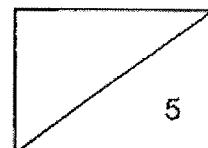

17

A container measuring 25 cm by 20 cm by 48 cm was $\frac{1}{3}$ -filled with water at first. After Daniel poured some water into the container, the height of the water in the container became 20 cm as shown below.

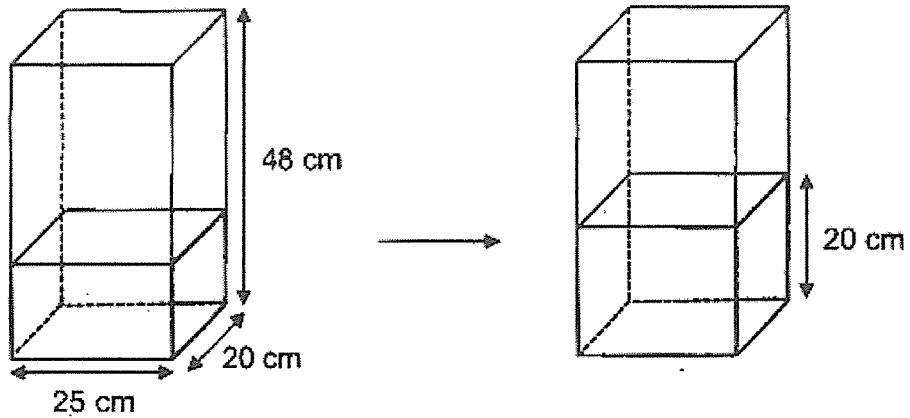

(a) How much water did Daniel pour into the container?

Ans: (a) _____ [2]

(b) Daniel used several identical bottles to fill the container with water to the brim. The capacity of each bottle was 0.5 l. How many of such identical bottles is needed to fill the container with water to the brim?

Ans: (b) _____ [3]

END OF PAPER

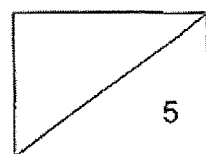

SCHOOL : RED SWASTIKA SCHOOL
LEVEL : PRIMARY 5
SUBJECT : MATH
TERM : SA2 2023

Q 1	Q2	Q3	Q4	Q5	Q6	Q7	Q8	Q9	Q10
2	3	1	4	2	3	3	4	4	4

Q 11	Q12	Q13	Q14	Q15
2	2	1	3	1

Q16) 67500

Q17) $17 \times 400 = 17 \times 4 \times 100$
 $= 68 \times 100 = 6800$

Q18) 32

Q19) 24 and 48

Q20) $\frac{8}{9}$

Q21) $1.03\text{L} = 1030\text{ml}$
 $1030 - 650 = 380$
 $380\text{ml} = 0.38\text{L}$

Q22) $9 + 5 = 14$
B : A
14 : 9

Q23) $90 + 56 = 146$
 $180 - 146 = 34^\circ$

Q24) A

Q25)	$680 - 65 = 615$ $615 \div 3 = 205$
Q26)	$240 \div 50 = 4R40$ $4 \times 6 = 24$
Q27)	$45 + 30 = 75$ $100 - 75 = 25$ $600/1 \times 25/1 = 150$
Q28)	$2 \times 20 = 40$ $3 \times 15 = 45$ $4 \times 5 = 20$ $40 + 45 + 40 + 20 = 145$ $145 \times 6 = \$870$
Q29)	$3u = 15$ $1u = 5$ $5 \times 8 = 40$ $40 \div 2 = 20$ $20 + 1 = 21$ $21 - 15 = 6$
Q30)	$\frac{1}{2} \times 6/1 \times 12/1 = 36$ $\frac{1}{2} \times 18/1 \times 12/1 = 108$ $108 + 36 = 144$ $144 - 120 = 24$ $24 \div 2 = 12\text{cm}^2$

Questions 1 to 5 carry 2 marks each. Show your workings clearly in the space below each question and write your answers in the spaces provided. For questions which require units, give your answers in the units stated.

(10 marks)

1 Use all the digits 3, 5, 9, 0 to form

0, 3, 5, 9

a) the smallest 4-digit odd number.

Ans: (a) 3059

b) the number closest to 5000.

Ans: (b) 5039

2 Lena bought 1.4 kg of tomatoes. How much did she pay?

80¢ per 100 g



$1400 \div 100 = 14$
 $14 \times 80 = 1120$

Ans: \$ 11.20



1

3 In the figure, BCDE is a rhombus. AB is a straight line. $\angle AED = 128^\circ$. Find $\angle BCD$.

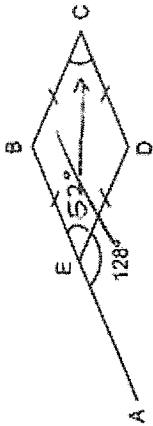

$180 - 128 = 52$

Ans: 52°

4 Min Yi had twice as many books as James. She gave 73 books to James. After that, Min Yi had 154 books more than James. How many books did Min Yi have at first?

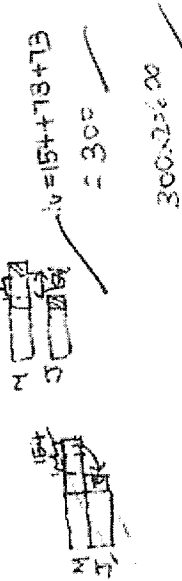

Ans: 300



2

5 Ahmad has two sticks, A and B. The length of A is 12 cm longer than the length of B.

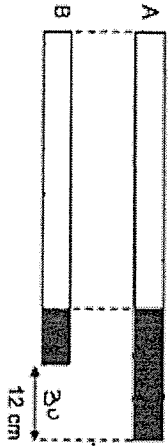

$\frac{1}{3}$ of A and $\frac{1}{6}$ of B are painted black.
What is the total length of sticks A and B?

$$\begin{aligned} \frac{A}{u:8 \rightarrow T} & \quad \frac{B}{u:5 \rightarrow T} \\ 2:1 \rightarrow 3 & \quad 4:2 \rightarrow 4 \\ 10:2 \rightarrow 12 & \quad 5:1 \rightarrow 7u \\ & \quad 10:5 \rightarrow 15 \end{aligned}$$

$$\begin{aligned} 5u - 2u &= 3u \\ 3u &= 12 \\ u &= 4 \\ 15 + 12 &= 27 \\ 27u &= 4 \times 27 \\ &= 108 \end{aligned}$$

Ans: 108 cm

3

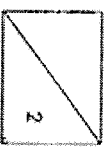

For Questions 6 to 17, show your workings clearly in the space below each question and write your answers in the spaces provided. The number of marks available is shown in brackets [] at the end of each question or part-question. (45 marks)

6 The table shows the rate of charges for each overdue book borrowed from a library.

For the first 5 days	30¢ per day	150
After the 5th day	60¢ per day	? + 70

Li Wei borrowed a book from the library which was overdue when he returned it. He paid a total of \$6.30 for the overdue book. How many days was it overdue?

$$\begin{aligned} 30 \times 5 &= 150 \\ 630 - 150 &= 480 \\ 480 \div 6 &= 8 \\ 8 + 5 &= 13 \end{aligned}$$

Ans: 13 days [3]

7 The ratio of Ali's age to his father's age is 1 : 4 now. In 5 years' time, their total age will be 70. How old is Ali now?

$$\begin{aligned} \frac{A}{1} & \quad \frac{F}{4} \\ 70 & \quad 70 \\ 70 - 5 - 5 &= 60 \\ 60 \div 5 &= 12 \end{aligned}$$

Ans: 12 years old [3]

4



- 8 Mr Tan paid \$151.20 for an equal number of pens and highlighters. Each pen cost \$1.20. Each highlighter cost \$1.80 more than a pen. How many pens did he buy?

$1P \rightarrow 1.20$
 $1H \rightarrow 1.20 + 1.80 = 3$
 $1P + 1H \rightarrow 3 + 1.2 = 4.2$
 $4.2 \times 36 = 151.2$

Ans: 36 [3]

- 9 In the diagram, UWW is a triangle. VYX and UYZ are straight lines. UY = YZ, VZ = ZW and WX is twice of XU. What is the area of the shaded part WXYZ?

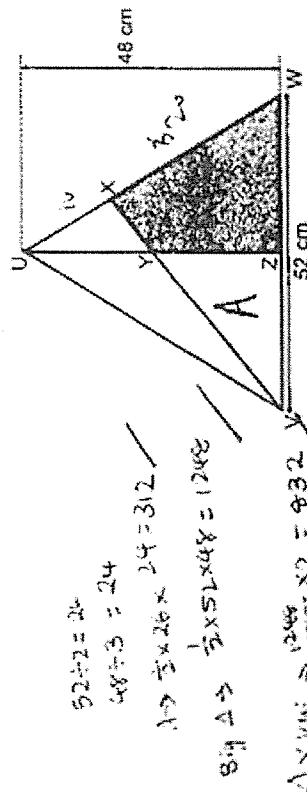

Ans: 544 cm² [3]

- 10 The square grid shows the side PQ of square PQRS and side AB of rectangle ABCD.

- a) Complete square PQRS by drawing 3 more lines. [1]
 b) The perimeter of rectangle ABCD is three times the perimeter of square PQRS. Complete rectangle ABCD by drawing 3 more lines. [2]

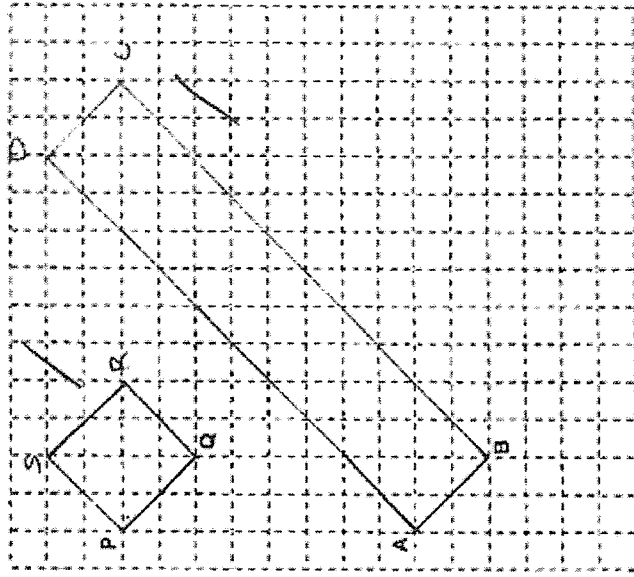

- 11 In the figure, ABCD is a rectangular piece of paper. It is folded as shown below. $\angle HJE = 67^\circ$ and $\angle FEG = 46^\circ$.

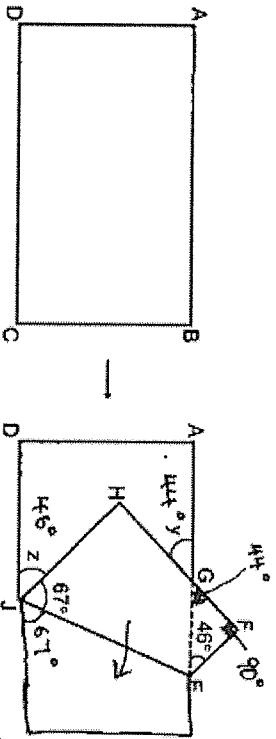

- a) Find $\angle y$.

$$180 - 90 - 46 = 44$$

Ans: (a) 44 [2]

- b) Find $\angle z$.

$$180 - 67 - 67 = 46$$

Ans: (b) 46 [2]

7

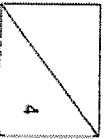

- 12

The graphs show the total number of cards machines A and B printed from the start. Both machines started printing at the same time. Both machines did not change their rates of printing throughout.

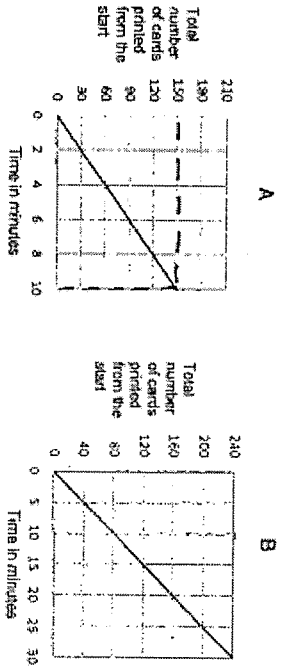

- a) How many more cards did machine A print than machine B in 10 minutes?

$$\text{In } 10 \text{ min}$$

$$A \rightarrow 150$$

$$B \rightarrow 80$$

$$150 - 80 = 70$$

Ans: (a) 70 [1]

- b) How long will it take for both machines to print 2760 cards together?

$$\text{In } 1 \text{ min}$$

$$A \rightarrow 15$$

$$B \rightarrow 8$$

$$15 + 8 = 23$$

$$2760 \div 23 = 120$$

Ans: (b) 120 min [3]

8

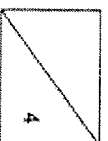

- 13 Joyce received a weekly allowance of \$50 from her mother. At the end of the week, she saved up the amount that she did not spend. The bar graph below shows her weekly savings.

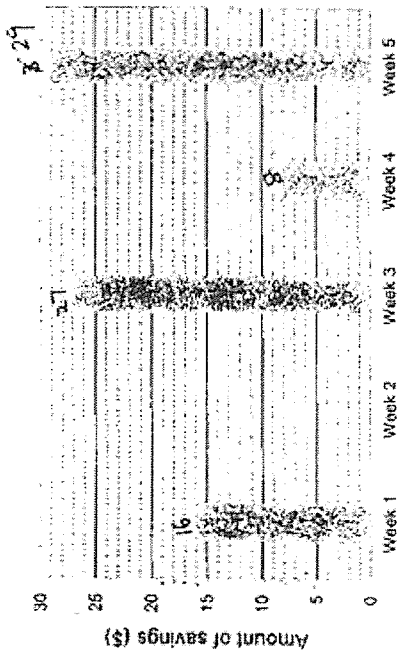

- (a) In which week did she spend the most?
 ↳ save the least

Ans: (a) Week 2 [1]

- (b) Find her average weekly spending.

$$0 + 16 + 27 + 8 + 29 = 80$$

Total allowance $\rightarrow 50 \times 5 = 250$

$$250 - 80 = 170$$

$$170 \div 5 = 34$$

Ans: (b) \$34 [1]



- 14 Yi Xin received the same number of coins from her mother every day for 60 days. Each coin was either a 10¢ or a 50¢ coin. Yi Xin gave her younger sister two 50¢ coins every 5 days. The total number of coins Yi Xin had left after 60 days was 216 and the total value of these coins was \$96.

- a) How many coins did Yi Xin receive from her mother each day?

$$2 \times 5 = 10$$

$$216 \div 10 = 21.6$$

To sister

$$5 \text{ days} \rightarrow 2 \text{ coins}$$

$$60 \text{ days} \rightarrow 24 \text{ coins} \times 12$$

From mom in 60 days

$$216 + 24 = 240$$

$$\text{Each day} \rightarrow 240 \div 60 = 4$$

Ans: (a) 4 [2]

- (b) How many of the coins Yi Xin had left after 60 days were 50¢ coins?

$$216 \text{ coins } \$96$$

Suppose all 216 coins left were 10¢

$$\text{Total value} \rightarrow 216 \times 10 = 2160$$

$$\text{Difference in total} \rightarrow 9600 - 2160 = 7440$$

$$\text{Diff} \rightarrow 50 - 10 = 40$$

$$\text{No. of } 50 \text{¢ coins} \rightarrow 7440 \div 40 = 186$$

Ans: (b) 186 [2]

Coins & check

$$(186 \times 0.5) + (216 - 186) = 96$$



15 There were 100 red beads, 40 green beads and 70 blue beads in a box.

(a) Dinah wanted to use some beads to make a bracelet. If $\frac{1}{2}$ of the beads in the bracelet were red, $\frac{1}{4}$ of the remainder were green and 12 beads were blue, how many beads would she need to make the bracelet?

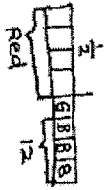

$$\frac{100}{2} = 50$$

$$40 + 50 = 90$$

$$90 - 12 = 78$$

$$78 \div 4 = 19.5$$

$$30 = 12$$

$$12 = 12 \div 3$$

$$= 4$$

Ans: (a) 32 [2]

(b) Using the original number of beads in the box, if Dinah wanted to make bracelets of a different pattern using 15 red beads, 5 green beads and 12 blue beads for each bracelet, how many of such bracelets can she make at most?

$$\frac{100}{15} = 6.66$$

$$\frac{40}{5} = 8$$

$$\frac{70}{12} = 5.83$$

Ans: (b) 5 [2]

11

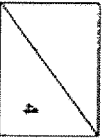

16 At ABC Bakery, doughnuts are sold at \$1.50 each. It is having the following promotion now.



SPECIAL OFFER!
For every 6 doughnuts, get 5% discount.
For every 10 doughnuts, get 8% discount
plus 1 FREE doughnut.

(a) Mrs Chan bought 6 doughnuts. How much did she pay?

$$6 \times 1.5 = 9$$

$$100 - 5 = 95$$

$$\frac{95}{100} \times 9 = 8.55$$

Ans: (a) \$8.55 [2]

(b) Mr Lim wanted to get 35 doughnuts. What was the least amount that he needed to pay for them?

$$35 = 10 + 10 + 10 + 1 + 1 + 1$$

$$10 \times 1.5 = 15$$

$$100 - 8 = 92$$

$$\frac{92}{100} \times 15 = 13.8$$

$$13.8 \times 3 = 41.4$$

$$15 + 41.4 + 1.5 = 57.9$$

Ans: (b) \$44.40 [3]

12



17

A container measuring 25 cm by 20 cm by 48 cm was $\frac{1}{3}$ -filled with water at first. After Daniel poured some water into the container, the height of the water in the container became 20 cm as shown below.

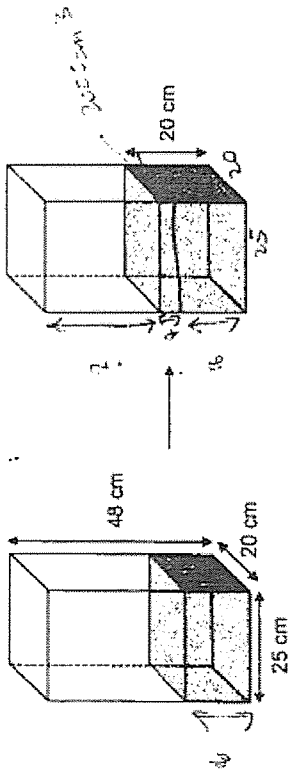

(a) How much water did Daniel pour into the container?

25
20
20
50

25 x 20 x 48 = 24000

20 x 20 x 25 = 10000

24000 - 10000 = 14000

Ans: (a) 14000 cm³ [2]

(b) Daniel used several identical bottles to fill the container with water to the brim. The capacity of each bottle was 0.5 l. How many of such identical bottles is needed to fill the container with water to the brim?

48 - 20 = 28

25 x 20 x 28 = 14000

14000 ÷ 0.5 = 28000

14000 ÷ 500 = 28

Ans: (b) 28 [3]

END OF PAPER

