



## 2023 PRIMARY 4 WEIGHTED ASSESSMENT 1

Name: \_\_\_\_\_ ( ) Date: 4 May 2023

Class: Primary 4 ( ) Duration: 45 minutes

Parent's Signature: \_\_\_\_\_ Marks: \_\_\_\_\_ / **30**

# MATHEMATICS

### INSTRUCTIONS TO CANDIDATES

1. Write your name, class and register number.
2. Do not turn over this page until you are told to do so.
3. Follow all instructions carefully.
4. Answer all questions.
5. Show your working clearly as marks are awarded for correct working.
6. Use a dark blue or black ballpoint pen to write your answers in the space provided for each question.
7. Do not use correction tape or highlighters for your solutions.



**Section A**

**Short Answer Questions**

Questions 1 to 15 carry 1 mark each. Write your answers in the boxes provided. For questions which require units, give your answers in the units stated.

[15 marks]

- 
1. Write thirteen thousand and forty-three in numerals.

- 
2. Use the digits below to form the smallest 5-digit even number.  
Each digit can be used only once.

9, 0, 5, 2, 1

- 
3. 19 508 people visited the National Museum. Round this number to the nearest thousand.

- 
4. Two factors of 27 are 1 and 27. What are the other two factors of 27?

5. Complete the following number pattern.

63 865, 62 865, 61 865, 60 865, \_\_\_\_\_

---

6.  $5\frac{2}{7} = \frac{\square}{7}$

What is the missing number in the box?

---

7. In the figure below, name the two angles that are greater than  $90^\circ$ .

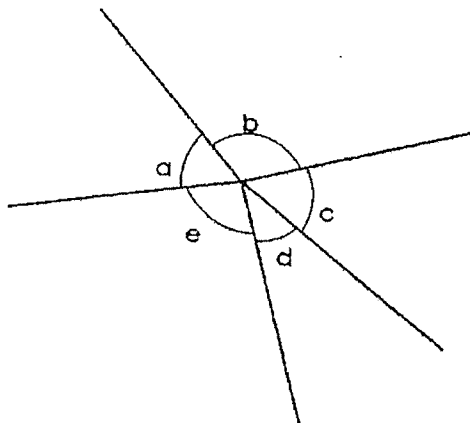

---

8. Find the sum of all the factors of 10.

9. Find  $\angle GHI$ .

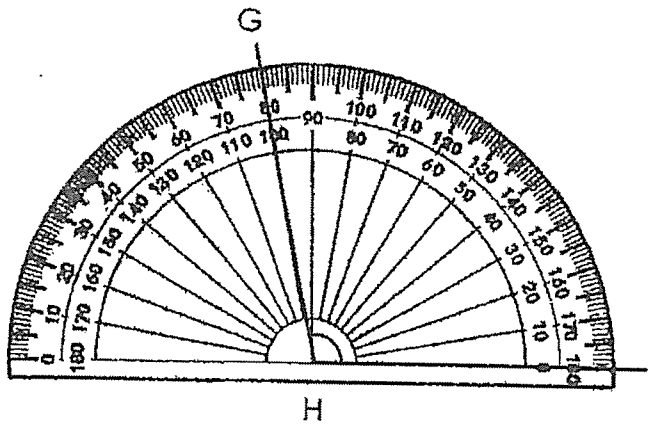

10. Arrange the following fractions in decreasing order.

$$1\frac{1}{6}, \quad \frac{3}{4}, \quad \frac{3}{2}$$

11. Meiling had some money. She spent  $\frac{5}{6}$  of the money and had \$18 left  
How much money did she have at first?

\$

---

12. Find the first two common multiples of 4 and 6.

and

---

13. Ahmad is facing north-west. When he turns  $225^\circ$  anticlockwise, which direction will he be facing?

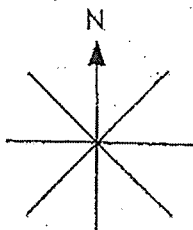

---

14. Tom and Jerry shared \$1550 between them. Jerry received \$90 less than Tom. How much money did Jerry receive?

\$

---

15. An odd number when rounded to the nearest hundred is 2800. What is the smallest possible value of this odd number?

---

**Section B**

Questions 16 to 20 carry 3 marks each.

Show all your workings and statements clearly.

[15 marks]

---

16. Eileen baked 2800 cookies. She sold them in packets of 8 for \$7 each.  
How much money did she collect?

She collected \_\_\_\_\_.

Ans: \_\_\_\_\_

---

17. Devi bought 24 curry puffs. She gave 6 curry puffs to her neighbour and her family ate 8 curry puffs. What fraction of the curry puffs were left?  
Express your answer in its simplest form.

\_\_\_\_\_ of the curry puffs were left.

Ans: \_\_\_\_\_

---



18. Study the diagram and answer the following questions.

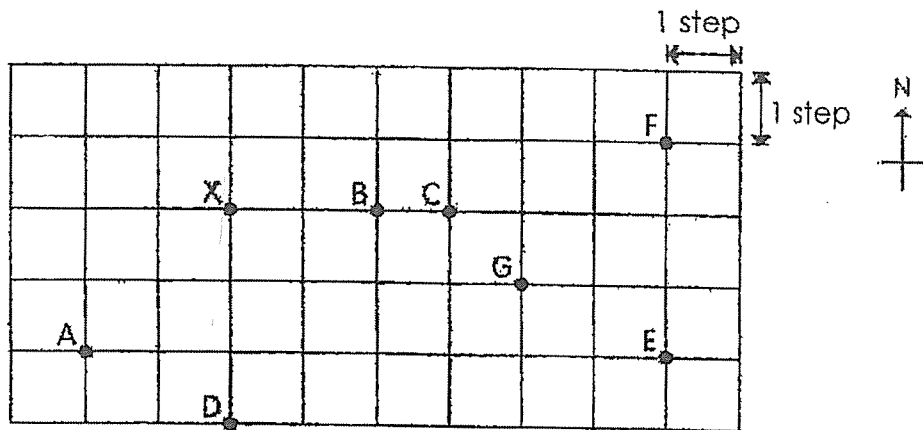

a) Which position is south-west of X?

Position \_\_\_\_\_ is south-west of X.

b) Derek started at Position X. He walked 3 steps due east, 1 step due north and then 3 steps due east. At which position did he end up?

Derek ended up at \_\_\_\_\_.

c) Samuel was at a certain position. He walked 2 steps due west and then 1 step due north. He ended at Position G.

What was his starting position?

His starting position was at \_\_\_\_\_.

Ans: a) \_\_\_\_\_

b) \_\_\_\_\_

c) \_\_\_\_\_

19. Alice is thrice as old as her cousin. Alice is 39 years old now.  
What is their total age in 2 years' time?

Their total age in 2 years' time is \_\_\_\_\_

Ans: \_\_\_\_\_

---

20. Mr Soh planted 27 rows of papaya trees in his orchard.  
There were 16 trees in each row.  $\frac{4}{9}$  of the papaya trees bore fruit.  
How many papaya trees bore fruit?

\_\_\_\_\_ papaya trees bore fruit.

Ans: \_\_\_\_\_

---

**End of Paper**





## 2023 PRIMARY 4 WEIGHTED ASSESSMENT 2

Name: \_\_\_\_\_ ( )      Date: 21 August 2023

Class: Primary 4 ( )      Duration: 45 minutes

Parent's Signature: \_\_\_\_\_      Marks: \_\_\_\_\_ / **30**

# MATHEMATICS

### INSTRUCTIONS TO CANDIDATES

1. Write your name, class and register number.
2. Do not turn over this page until you are told to do so.
3. Follow all instructions carefully.
4. Answer all questions. Show your working clearly.
5. Use a blue ballpoint pen to write your answers.

**Section A**

**Short Answer Questions**

Questions 1 to 15 carry 1 mark each. Write your answers in the boxes provided. For questions which require units, give your answers in the units stated.

[15 marks]

- 
1. Find the product of 423 and 56.

- 
2. Convert  $1\frac{7}{25}$  to a decimal.

- 
3. Express 83 tenths as a decimal.

- 
4. Find the value of  $12 \div 5$ .  
Give your answer as a decimal.

5. Arrange these numbers in increasing order.

**4.206, 4.026, 4.26, 4.602**

---

_____
-------

---

6. Measure  $\angle x$ .

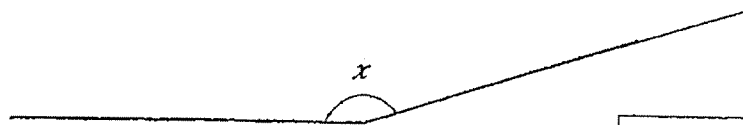

○
---

---

7. ABCD is a rectangle. Find the length of CD.

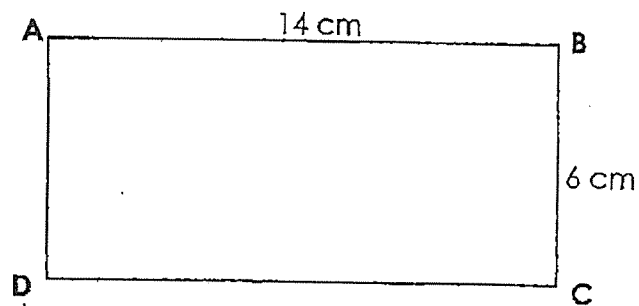

_____ cm
----------

---

8. Draw a square using the given line.

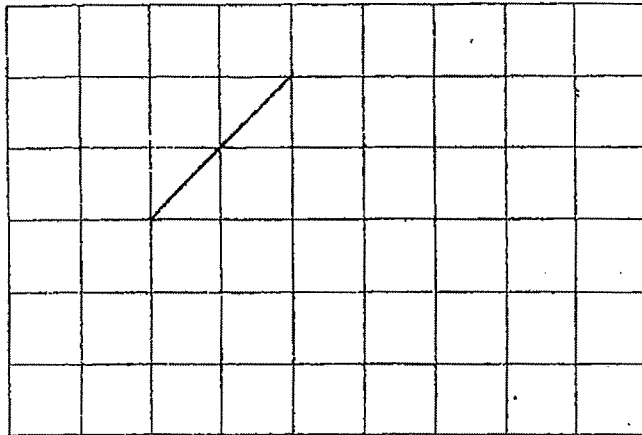

9. The figure is made up of rectangle ABCG and square CDEF. Find  $\angle ECH$ .

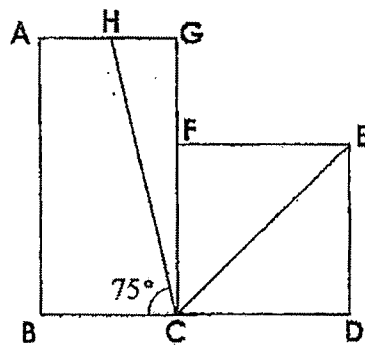

10. Which of the following figures are symmetric?

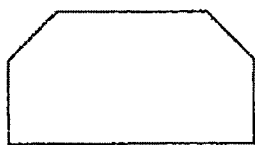

A



B



C

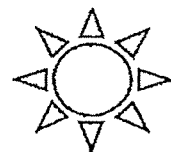

D

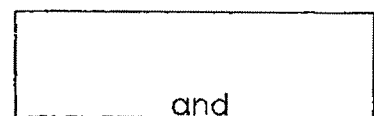



11. How many lines of symmetry are there in the figure below?

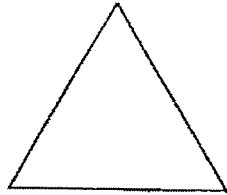

- 
12. Complete the symmetric pattern below with XY as the line of symmetry.

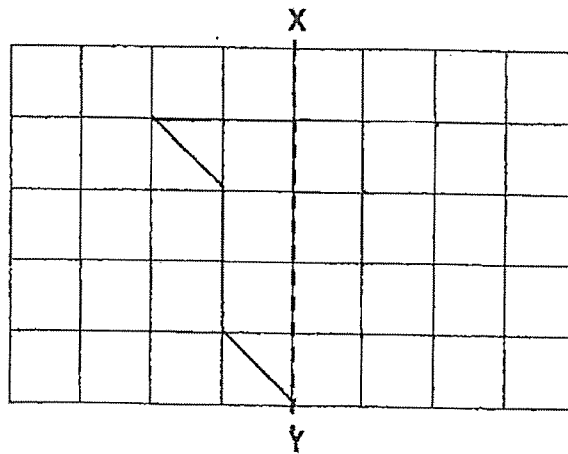

- 
13. After turning  $225^\circ$  anti-clockwise, Devi was facing north-west. Which direction was Devi facing at first?

14. A fence was 5.6 m long. 1.25 m of the fence was painted red and the rest was painted white. What was the length of the fence that was painted white?

---

  
m

- 
15. A number is greater than 7.85 but smaller than 7.95. The value of the digit 3 is 0.03. The digit 1 stands for  $\frac{1}{1000}$ . What is the number?  
Express your answer as a decimal.

**Section B**

Questions 16 to 20 carry 3 marks each.

Show all your workings and statements clearly.

[15 marks]

- 
16. Wei Jia mixed 0.25 l of rose syrup with 1.2 l of milk to make Bandung drink for her guests. She then poured the Bandung drink equally into 8 glasses. How much Bandung drink was there in each glass?  
Give your answer correct to 2 decimal places.

There was \_\_\_\_\_

Ans : \_\_\_\_\_

17. The total mass of a box containing a watermelon and a papaya is 3.85 kg. The watermelon is twice as heavy as the papaya. The papaya is twice as heavy as the box. What is the mass of the watermelon?

The mass of the watermelon is \_\_\_\_\_

Ans : \_\_\_\_\_

18. The figure below is made up of a rectangle and a square. Find  $\angle z$ .

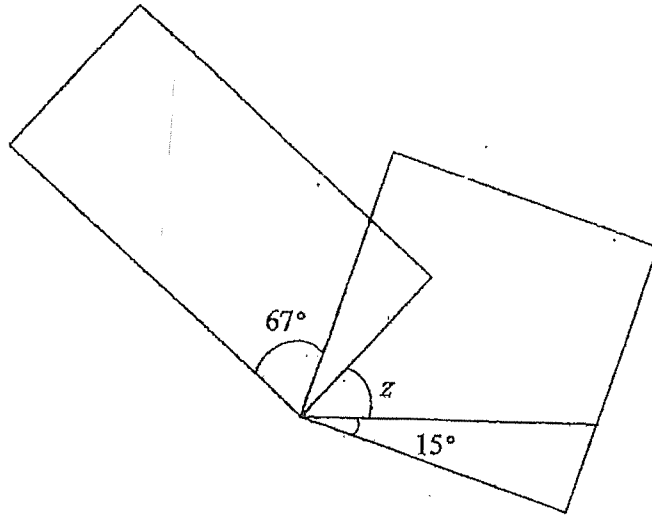

$\angle z$  is \_\_\_\_\_

Ans: \_\_\_\_\_

19. Mrs Khan baked some cupcakes for her students.  
If she gave each student 3 cupcakes, she would have 5 cupcakes remaining.  
If she gave each student 4 cupcakes, she would need another 3 cupcakes.  
How many cupcakes did Mrs Khan bake?

Mrs Khan baked \_\_\_\_\_

Ans: \_\_\_\_\_

---

20. Emir had \$6.40. After giving \$1.20 to his brother, Emir had half the amount as his brother. What was the total amount they had altogether?

They had \_\_\_\_\_

Ans: \_\_\_\_\_

---

**End of Paper**





SCHOOL : TAO NAN PRIMARY SCHOOL  
 LEVEL : PRIMARY 4  
 SUBJECT : MATHEMATICS  
 TERM : 2023 WA1 & WA2

**WA1**

Q1	13043
Q2	10592
Q3	20000
Q4	3 and 9
Q5	59865
Q6	37
Q7	$\sphericalangle$ b and $\sphericalangle$ e
Q8	18
Q9	100°
Q10	$\frac{3}{2}$ , $1\frac{1}{6}$ , $\frac{3}{4}$
Q11	1u = \$18 6u = 6 x \$18 = <b>\$108</b>
Q12	12 and 24
Q13	East
Q14	\$1550 - \$90 = \$1460 \$1460 ÷ 2 = <b>\$730</b>
Q15	2751
Q16	No. of packets = 2800 ÷ 8 = 350 Amt. of money = 350 x \$7 = <b>\$2450</b>
Q17	Left = 24 - 6 - 8 = 10 Fraction left = $\frac{10}{24} = \frac{5}{12}$
Q18	a) Position A                      b) F                      c) E
Q19	Cousin's age now = 39 ÷ 3 = 13 Alice's age in 2 years = 39 + 2 = 41 Cousin's age in 2 years = 13 + 2 = 15 Total age in 2 years = 15 + 41 = <b>56</b>

Q20	$9u = 27 \times 16 = 432$ $1u = 48$ $4u = 4 \times 48 = \mathbf{192}$
-----	---

**WA2**

Q1	23688
Q2	1.28
Q3	8.3
Q4	2.4
Q5	4.026, 4.206, 4.26, 4.602
Q6	163°

SCHOOL : TAO NAN PRIMARY SCHOOL  
LEVEL : PRIMARY 4  
SUBJECT : MATHEMATICS  
TERM : 2023 WA2

---

**WA2**

Q1	23688
Q2	1.28
Q3	8.3
Q4	2.4
Q5	4.026, 4.206, 4.26, 4.602
Q6	163°

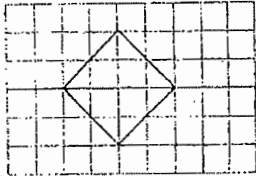
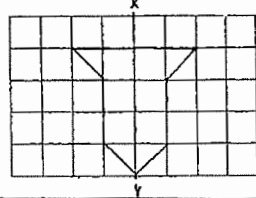
Q7	14 cm	Q8	
Q9	$75 + 45 = 120$ $180 - 120 = 60^\circ$	Q10	A and D
Q11	3	Q12	
Q13	South	Q14	$5.6 - 1.25 = 4.35\text{m}$
Q15	7.931	Q16	$1.2 \div 0.25 = 1.45$ $1.45 \div 8 = 0.181$ $1.181 \approx 0.18$ There were 0.18L of bandung drink in each glass.
Q17	1 unit $\rightarrow 3.85 \div 7 = 0.55\text{kg}$ 4 units $\rightarrow 0.55\text{kg} \times 4 = 2.2\text{kg}$ The mass of the watermelon is 2.2kg	Q18	$90 - 67 = 23$ $23 + 15 = 38$ $90 - 38 = 52$ Z is $52^\circ$
Q19	*Guess and check method* Each student 3 cupcakes 3 student $\rightarrow (3 \times 8) + 5 = 24 + 5 = 29$ 4 student $\rightarrow (4 \times 8) - 3 = 32 - 3 = 29$ (bake another 3 cupcake) Mrs Khan baked 29 cupcakes.	Q20	$\$6.40 - \$1.20 = \$5.20$ $\$5.20 \times 3 = \$15.60$ They had \$15.60 altogether.