



**PEI HWA PRESBYTERIAN PRIMARY SCHOOL
SEMESTRAL ASSESSMENT**

**PRIMARY 4
MATHEMATICS PAPER
24 OCTOBER 2023**

Name: _____ ()

Class: 4TW _____

Parent's signature

Total time: 1h 45min

INSTRUCTIONS TO CANDIDATES

1. Write your Name, Class and Register No. in the spaces provided above.
2. DO NOT turn over this page until you are told to do so.
3. Follow all instructions carefully.
4. Answer all questions.
5. For Section A, shade your answers on the Optical Answer Sheet (OAS) provided.
6. Write all your answers in this booklet.

Marks :

100

This booklet consists of 21 printed pages, excluding the cover page.

Section A: Multiple Choice Questions (20 × 2 = 40 marks)

For each question, four options are given. One of them is the correct answer. Make your choice (1, 2, 3 or 4). Shade the oval (1, 2, 3 or 4) on the Optical Answer Sheet.

1 73 thousands and 8 tens is the same as _____.

(1) 738

(2) 7380

(3) 73 008

(4) 73 080

()

2 13 845 rounded to the nearest hundred is _____.

(1) 13 800

(2) 13 850

(3) 13 900

(4) 14 000

()

3 $7\frac{4}{5} = \frac{\boxed{?}}{5}$

What is the missing number in the box?

(1) 28

(2) 31

(3) 35

(4) 39

()

- 4 What fraction of the shapes in the box are \blacklozenge ?

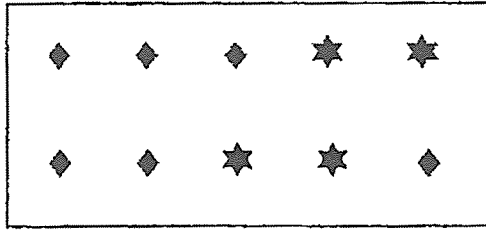

(1) $\frac{4}{6}$

(2) $\frac{4}{10}$

(3) $\frac{6}{10}$

(4) $\frac{6}{4}$

()

- 5 In the number 45.67, the digit _____ is in the tenths place.

(1) 7

(2) 6

(3) 5

(4) 4

()

- 6 Write $4\frac{3}{20}$ as a decimal.

(1) 4.32

(2) 4.3

(3) 4.15

(4) 4.015

()

7 Arrange these numbers from the smallest to the greatest.

5709	5079	5790
------	------	------

Smallest

Greatest

(1) 5790 , 5709 , 5079

(2) 5790 , 5079 , 5709

(3) 5079 , 5709 , 5790

(4) 5079 , 5790 , 5709 ()

8 Which of the following is a multiple of both 3 and 4?

(1) 7

(2) 9

(3) 16

(4) 24 ()

9 Beads are used to form a pattern as shown. How many beads will there be in Figure 6?



Figure 1

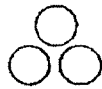

Figure 2

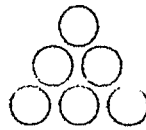

Figure 3

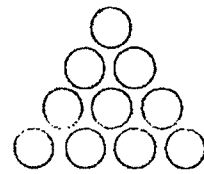

Figure 4

(1) 15

(2) 20

(3) 21

(4) 28 ()

- 10 Which of the numbers when rounded to the nearest tenth becomes 82.3?
- (1) 82.24
 - (2) 82.34
 - (3) 82.235
 - (4) 82.354 ()
- 11 Which of the following decimals is closest in value to 0.5?
- (1) 0.4
 - (2) 0.6
 - (3) 0.46
 - (4) 0.56 ()
- 12 Mrs Lee bought 9 similar packets of milk.
After she used 6 packets of milk to make some cakes, she had 3.42 ℓ of milk left.
How many litres of milk did she have at first?
- (1) 6.84 ℓ
 - (2) 10.26 ℓ
 - (3) 11.58 ℓ
 - (4) 13.68 ℓ ()

- 13 Similar balloons are tied on a pole and placed at an equal distance. Both ends of the pole are tied with balloons. The distance between two balloons is 1.65 m. What is the total distance between 8 balloons?

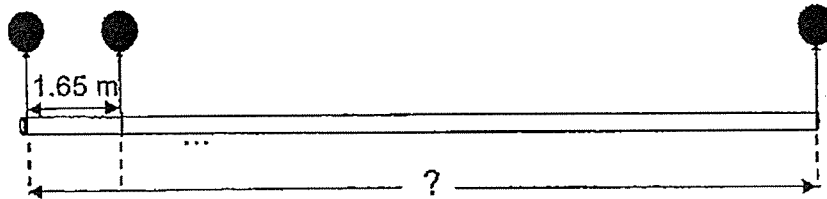

- (1) 9.9 m
 (2) 11.55 m
 (3) 13.2 m
 (4) 14.85 m ()

- 14 ABCD is a rectangle. Find $\angle x$.

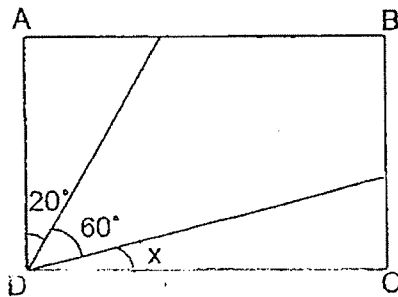

- (1) 10°
 (2) 30°
 (3) 70°
 (4) 80° ()

- 15 Study the piece of folded paper.



Which symmetrical figure was cut out from it?

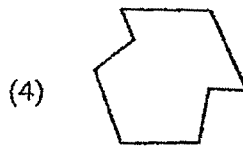
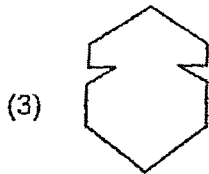
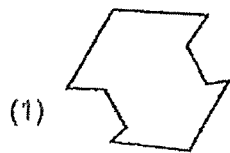

()

- 16 Jan has $\frac{3}{4}$ m of cloth. She has $\frac{1}{2}$ m more cloth than Helen.
How much cloth do they have altogether?

(1) $\frac{1}{4}$ m

(2) 1 m

(3) $1\frac{1}{4}$ m

(4) 2 m

()

17 How many minutes does it take for a minute hand of a clock to make $1\frac{1}{4}$ turn round the clock?

(1) 45 min

(2) 60 min

(3) 75 min

(4) 115 min

()

18 Jenny was working from 11 10 to 13 05.
How much time did she take to complete her work?

(1) 2 h 15 min

(2) 2 h 05 min

(3) 1 h 55 min

(4) 1 h 15 min

()

19 The area of a square is 36 cm^2 . What is the perimeter of the square?

(1) 6 cm

(2) 24 cm

(3) 36 cm

(4) 72 cm

()

20 The graph below shows the hourly sales at a departmental store on Saturday.

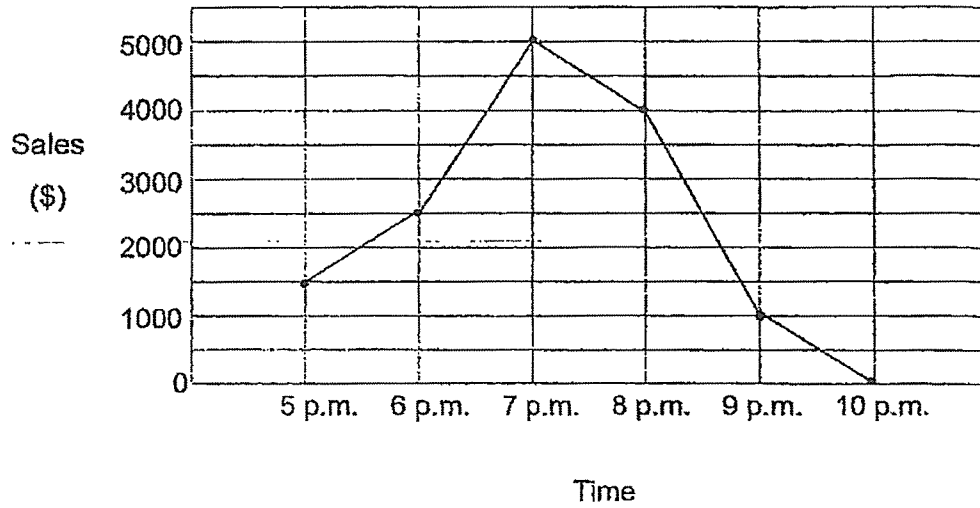

During which one-hour interval had the greatest decrease in sales?

- (1) 6 p.m. to 7 p.m.
- (2) 7 p.m. to 8 p.m.
- (3) 8 p.m. to 9 p.m.
- (4) 9 p.m. to 10 p.m.

()

Section B (20 × 2 = 40 marks)

Show your working clearly and write your answers in the spaces provided.
For questions which require units, give your answer in the units stated.

21 Write the missing number in the number pattern below.

14 000, 13 400, 12 800, 12 200, _____, 11 000

Ans: _____

22 Two factors of 6 are 1 and 6. What are the other two factors of 6?

Ans: ____ and ____

23 What is the remainder when 1095 is divided by 9?

Ans: _____

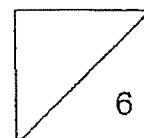

24 Find the value of $1 - \frac{1}{8} - \frac{1}{4}$.

Ans: _____

25 Write $2\frac{3}{7}$ as an improper fraction.

Ans: _____

26 Express 0.6 as a fraction.

Ans: _____

27 Find the value of 4.73×8 .

Ans: _____

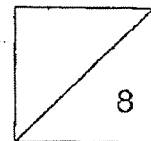

28 $7.21 - 5.38 = \underline{\hspace{2cm}}$.

Round your answer to the nearest 1 decimal place.

Ans:

29 In the figure, one of the angles is a right angle. Name the angle.

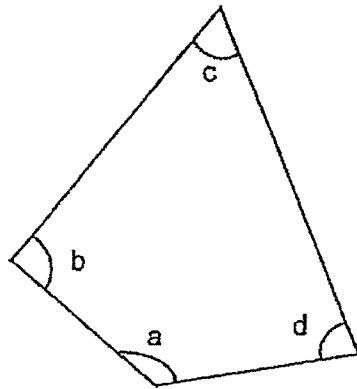

Ans: \angle

30 Measure and write down the size of $\angle x$.

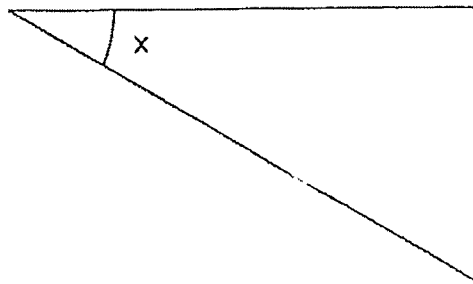

Ans:

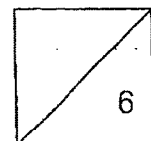

- 31 David spent $\frac{1}{5}$ of his money on a wallet and gave \$90 to his mother.
He had \$104 left. How much money did he spend on the wallet?

Ans: \$ _____

- 32 Doughnuts are sold in boxes of 6, 3 and 2.
John bought exactly 119 doughnuts.
What was the least number of boxes of each type of doughnuts John bought?

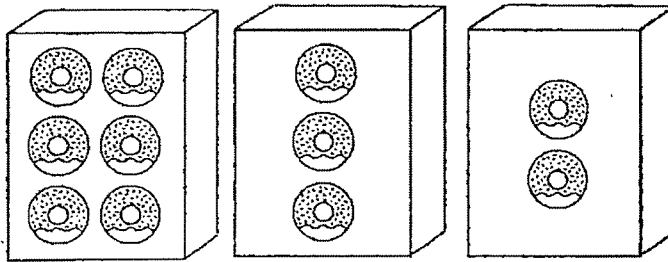

Ans : _____ box(es) of 6
 _____ box(es) of 3
 _____ box(es) of 2

- 33 Complete the symmetric figure below with line AB as the line of symmetry.

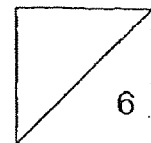
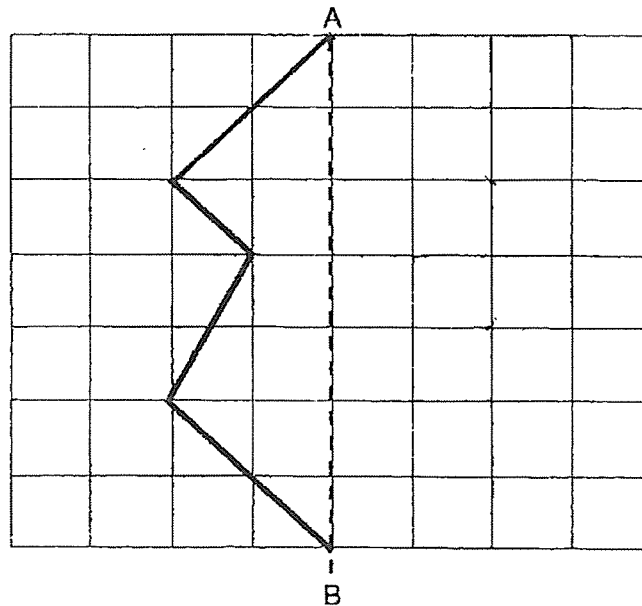

- 34 The table describes the properties of different figures W, X, Y and Z. Which figure is most likely to be a rectangle?

Property	Figure			
	W	X	Y	Z
Has four sides	✓	✓	✓	
All sides are equal in length		✓	✓	
At least one right angle in the figure	✓		✓	✓
Exactly two pairs of parallel lines	✓	✓	✓	

Ans: Figure _____

- 35 The figure is made up of a square ABEF and a rectangle BCDE. The area of the square is 16 cm^2 . What is the area of the figure ACDF?

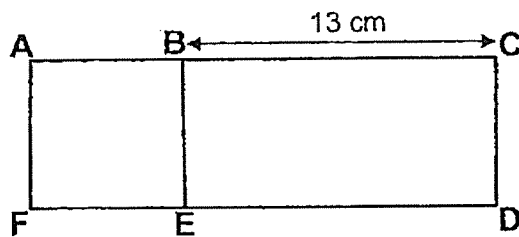

Ans: _____ cm^2

- 36 Find the perimeter of the following figure.

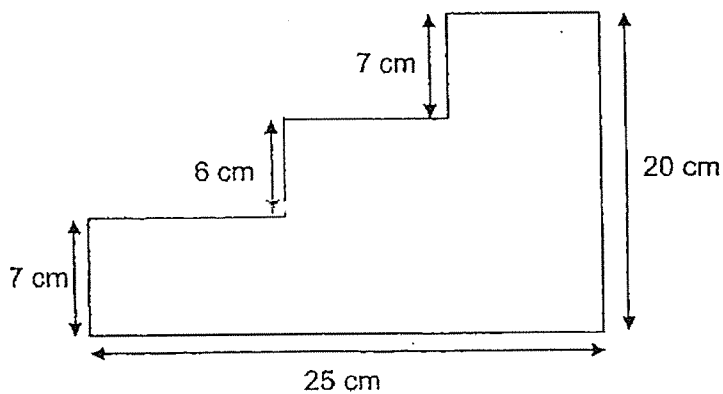

Ans: _____ cm

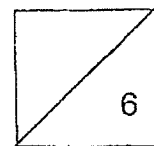

37 The plan of the garden is shown in the square grid.

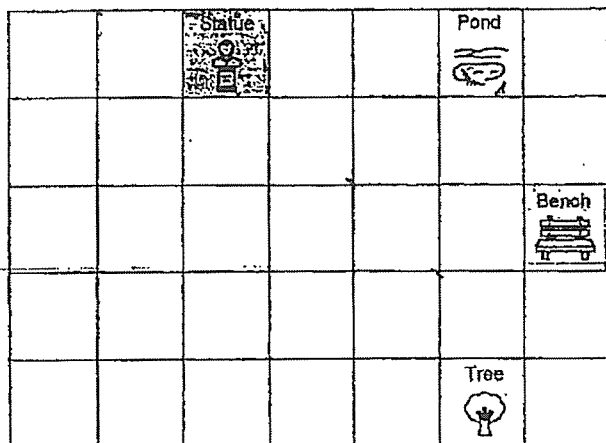

a) In which direction is the pond from the tree?

Ans: a) _____

b) May is in the garden.
 She stands at a location south-east of the statue and west of a bench.
 Cross out (x) in the square where May is standing.

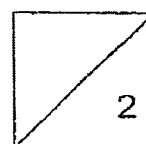

38 The line graph shows the amount of rainfall over 8 months.

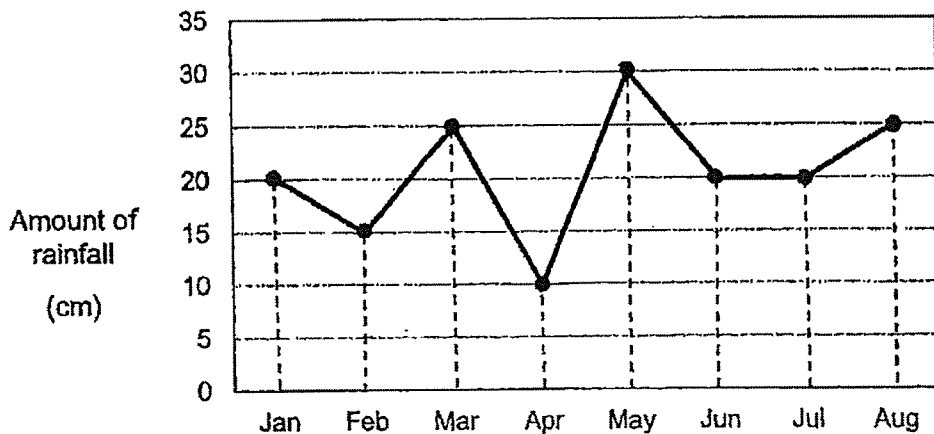

Which months had the same amount of rainfall?

Ans: _____

39 The table below shows the number of marbles that 4 children have. Some numbers are missing in the table.

	Blue	Red	Total
Sandy	?	13	?
Russell	5	5	10
Elena	11	17	28
Matt	9	?	?

Sandy, Matt and Elena have the same total number of marbles. How many red marbles does Matt have?

Ans: _____

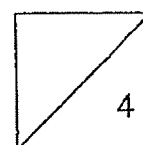

- 40 The table below shows the number of problem sums solved by each pupil in a group. Part of the table is covered by an ink blot. There were 35 pupils who solved 2 or more problem sums.

Number of problem sums	0	1	2	3	4
Number of pupils	7	6	20		

Each of the statements is either true or false from the information given. For each statement, put a tick (✓) to indicate your answer.

Statement	True	False
7 pupils did not solve any problem sums.		
The number of pupils who solved 3 problem sums is equal to the number of pupils who solved 4 problem sums.		
There were 67 pupils in the group altogether.		

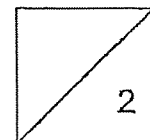

Section C (5 × 4 = 20 marks)

For questions 41 to 45, show your working and number statements clearly. Write your answers in the spaces provided. The number of marks available is shown in brackets [] at the end of each question or part question.

Working

41 At a concert, $\frac{3}{10}$ of the audience are women and $\frac{1}{5}$ of the audience are men. The rest of the audience are children.

(a) What fraction of the audience are children?

[Leave your answer in the simplest form]

Ans: (a) _____ [2]

(b) There are 180 more children than women.

How many women and men are there altogether?

Ans: (b) _____ [2]

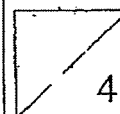

Working

42 Andy, Ben and Cindy share \$1900 altogether.

Ben has \$145 more than Cindy.

Cindy has twice as much money as Andy.

(a) How much money does Andy have?

Ans: (a) _____ [2]

(b) Find the total amount of money Ben and Cindy have.

Ans (b) _____ [2]

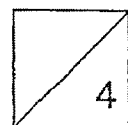

Working

43 A bottle had some amount of milk at first. Peter drank $\frac{1}{4}$ ℓ of milk in the morning and $\frac{1}{5}$ ℓ of milk in the afternoon.

(a) How many litres of milk did Peter drink in total?

Ans: (a) _____ [2]

(b) Peter had $\frac{3}{5}$ ℓ of milk at first. What was the amount of milk left in the bottle?

Ans: (b) _____ [2]

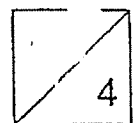

Working

44 Mr Tan had an equal number of apples and oranges.
After giving 48 apples and 36 oranges to Mr Lim, the oranges left was three times the number of apples left.

(a) How many apples did Mr Tan have at first?

Ans: (a) _____ [3]

(b) How many oranges were left?

Ans: (b) _____ [1]

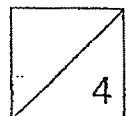

45 The table below shows the start time of each of Jean's activities every Sunday.

Time	Activity
08 00	Wake up and wash up
08 15	Breakfast
08 50	Art and Craft
10 50	Watch TV
?	Play computer games
13 25	Lunch

- (a) Jean spent 90 minutes on computer games before having lunch. What time did she start playing? Express the time using the 12-hour clock. Draw a timeline to represent the situation.

Ans: (a) _____ [2]

- (b) During the Art and Craft activity, Jean formed a figure by pasting 2 identical square papers over one another as shown. Find the total area of the figure formed.

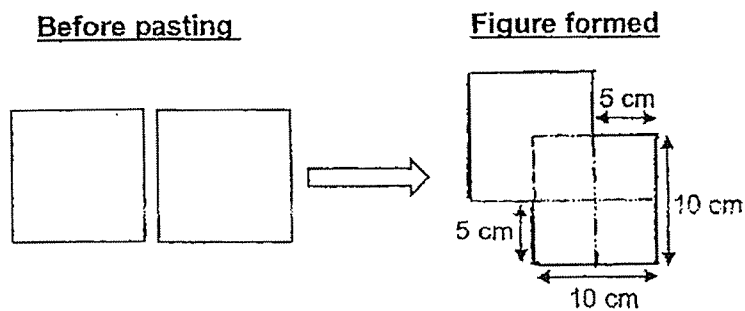

Ans: (b) _____ [2]

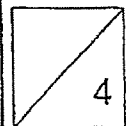

SCHOOL : PEI HWA PRESBYTERIAN PRIMARY SCHOOL
LEVEL : PRIMARY 4
SUBJECT : MATHEMATICS
TERM : 2023 SA2

BOOKLET A

Q1	4	Q2	1	Q3	4	Q4	3	Q5	2
Q6	3	Q7	3	Q8	4	Q9	3	Q10	2
Q11	3	Q12	2	Q13	2	Q14	1	Q15	1
Q16	2	Q17	3	Q18	3	Q19	2	Q20	3

BOOKLET B

Q21	11 600
Q22	2 and 3
Q23	6
Q24	$\frac{5}{8}$
Q25	$\frac{17}{7}$
Q26	$\frac{6}{10} = \frac{3}{5}$
Q27	37.84
Q28	1.8
Q29	Angle b
Q30	30°
Q31	$\$104 + \$90 = \$194$ $4U \rightarrow \$194$ $1U \rightarrow \$194 \div 4 = \48.50 (Ans)
Q32	Ans : 19 boxes of 6 1 box of 3 1 box of 2

Q33	
Q34	Figure W
Q35	$16 = 4 \times 4$ $13+4=17$ $17 \times 4 = 68$ (Ans : 68 cm^2)
Q36	Perimeter = $25 + 20 + 25 + 20 = 90$ (Ans : 90 cm)
Q37	<p>(a) North</p> <p>(b)</p>
Q38	January, June and July
Q39	$28-9=19$
Q40	<p>True</p> <p>False</p> <p>False</p>
Q41	<p>(a) $\frac{1}{5} + \frac{3}{10} = \frac{2}{10} + \frac{3}{10} = \frac{5}{10}$ (Ans : $\frac{1}{2}$ of the audience were children)</p> <p>(b) $\frac{5}{10} - \frac{3}{10} = \frac{2}{10}$</p> <p>$2U \rightarrow 180$</p> <p>$1U \rightarrow 180 \div 2 = 90$</p> <p>180 children $\rightarrow 90$</p> <p>$5U \rightarrow 90 \times 5 = 450$ (Ans)</p>
Q42	<p>(a) $\\$1900 - \\$145 = \\$1755$</p> <p>$5U \rightarrow \\1755</p> <p>$1U \rightarrow \\$1755 \div 4 = \\351 (Ans)</p> <p>(b) $4U \rightarrow \\$351 \times 4 = \\1404</p> <p>$\\$1404 + \\$145 = \\$1549$ (Ans)</p>
Q43	(c) $\frac{1}{5} + \frac{1}{4} = \frac{4}{20} + \frac{5}{20} = \frac{9}{20}$ (Ans : $\frac{9}{20} \text{ e}$)

	$(d) \frac{3}{5} = \frac{12}{20}$ $\frac{12}{20} - \frac{9}{20} = \frac{3}{20} \text{ (Ans : } \frac{3}{20} \text{ e)}$
Q44	<p>(a) $2U \rightarrow 48 - 36 = 12$ $1U \rightarrow 12 \div 2 = 6$ $48 + 6 = 54$ (Ans)</p> <p>(b) $3U \rightarrow 6 \times 3 = 18$ (Ans)</p>
Q45	<p>(a) 1.25 pm - 90 min \rightarrow 11.55 am</p> <p>(b) $10 \times 10 = 100$ $100 \times 2 = 200$ $5 \times 5 = 25$ $200 - 25 = 175$ (Ans : 175 cm²)</p>

