



NAN HUA PRIMARY SCHOOL
END OF YEAR EXAMINATION 2023
PRIMARY FOUR

MATHEMATICS

Total Time : 1 hour 45 minutes

INSTRUCTIONS TO CANDIDATES

1. Write your name, register number and class in the space provided.
2. Do not turn over the page until you are told to do so.
3. Follow all instructions carefully.
4. Answer all questions.
5. Shade your answers in the Optical Answer Sheet (OAS) provided for Questions 1 to 20.
6. Use dark blue or black ball point pen to write your answers in the space provided for each question.
7. Do not use correction tape/ fluid/ highlighter.

Marks Obtained

Section	Maximum Marks	Actual Marks
A	40	
B	40	
C	20	
Total	100	

Name : _____ ()

Form Class : P4 _____

Teaching Group: 4M _____

Date : 26 October 2023

Parent's Signature : _____

This booklet consists of 20 printed pages.



Section A

Questions 1 to 20 carry 2 marks each.

For each question, four options are given. One of them is the correct answer.

Make your choice (1, 2, 3 or 4) and shade your answer on the Optical Answer Sheet.

(40 marks)

1 The value of the digit 5 in 75 412 is _____.

- (1) 50
- (2) 500
- (3) 5000
- (4) 50 000

2 32 769 rounded to the nearest hundred is _____.

- (1) 32 700
- (2) 32 770
- (3) 32 800
- (4) 33 000

3 $7\frac{4}{5} = \frac{\square}{5}$

What is the missing number in the box?

- (1) 28
- (2) 31
- (3) 35
- (4) 39

4 Express 0.08 as a fraction in its simplest form.

(1) $\frac{2}{25}$

(2) $\frac{4}{5}$

(3) $\frac{1}{10}$

(4) $\frac{1}{8}$

5 Write $6\frac{7}{20}$ as a decimal.

(1) 6.72

(2) 6.7

(3) 6.35

(4) 6.072

6 In the figure shown, ABCD is a square. Find $\angle x$.

(1) 75°

(2) 70°

(3) 55°

(4) 35°

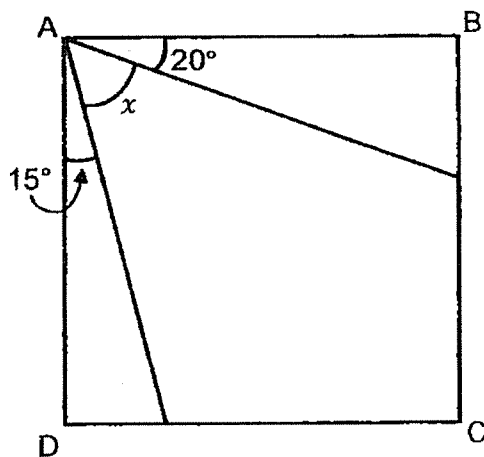

(Go on to the next page)

7 The mass of the box of biscuit is _____.

- (1) 30 g
- (2) 300 g
- (3) 1 kg 30 g
- (4) 1 kg 300 g

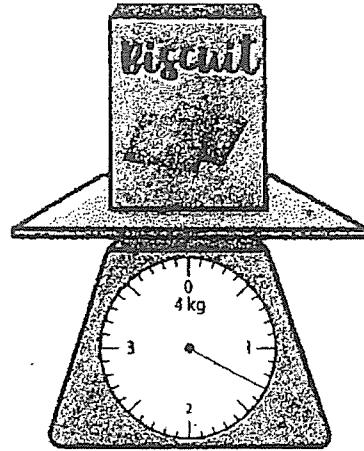

8 In the figure below, which two lines are perpendicular?

- (1) AB and BC
- (2) AB and AD
- (3) AB and DC
- (4) AD and BC

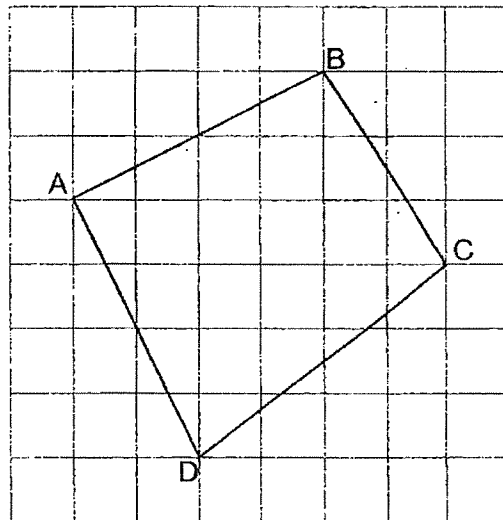

9 Which of the following figure has a line of symmetry?

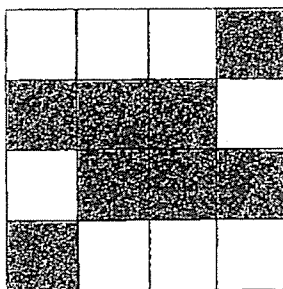

(1)

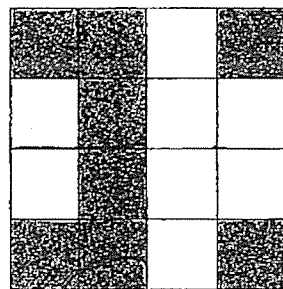

(2)

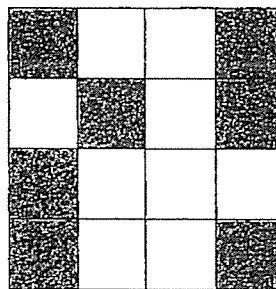

(3)

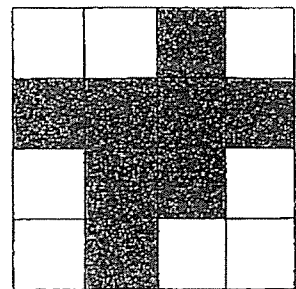

(4)

10 Which of the following figures are symmetrical?

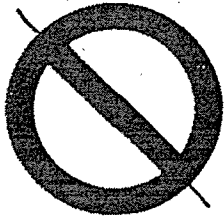

A

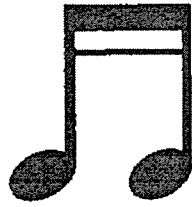

B

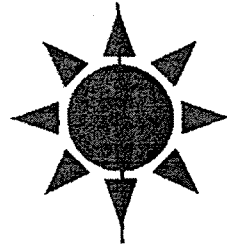

C



D

- (1) A and B
 (2) A and C
 (3) B and C
 (4) B and D

11 Arrange the following fractions from the greatest to the smallest.

$$1\frac{1}{9} \quad \frac{11}{7} \quad \frac{8}{7}$$

- | | <u>Greatest</u> | | <u>Smallest</u> |
|-----|-----------------|---|-----------------|
| (1) | $1\frac{1}{9}$ | , | $\frac{8}{7}$ |
| | | , | $\frac{11}{7}$ |
| (2) | $\frac{11}{7}$ | , | $1\frac{1}{9}$ |
| | | , | $\frac{8}{7}$ |
| (3) | $\frac{8}{7}$ | , | $1\frac{1}{9}$ |
| | | , | $\frac{11}{7}$ |
| (4) | $\frac{11}{7}$ | , | $\frac{8}{7}$ |
| | | , | $1\frac{1}{9}$ |

(Go on to the next page)

- 12 In the diagram below, Alice is standing at point A facing the stadium. She makes a 225° anticlockwise turn. Where is she facing now?

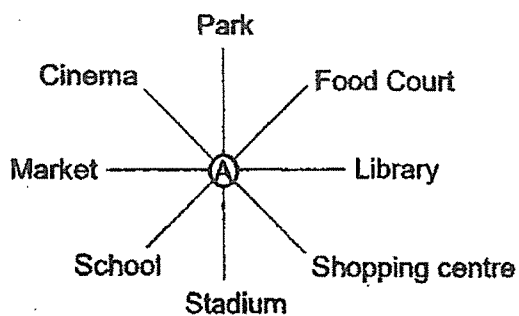

- (1) Cinema
 (2) Food Court
 (3) School
 (4) Shopping centre
- 13 On Monday, 100 children visited the zoo. The number of children at a zoo decreased by 30 from Monday to Tuesday and increased by 50 from Tuesday to Wednesday. Which graph shows the number of children from Monday to Wednesday?

(1)

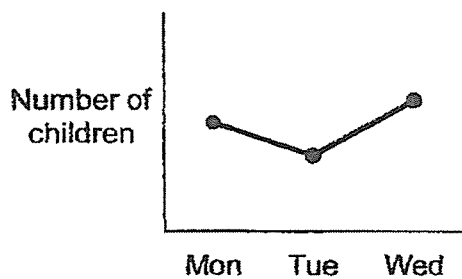

(2)

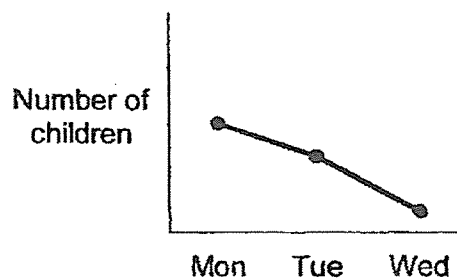

(3)

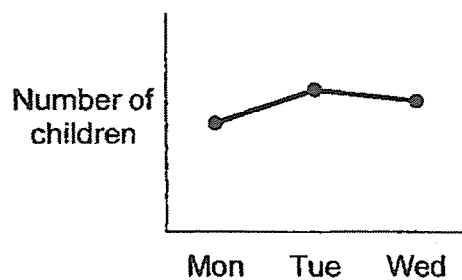

(4)

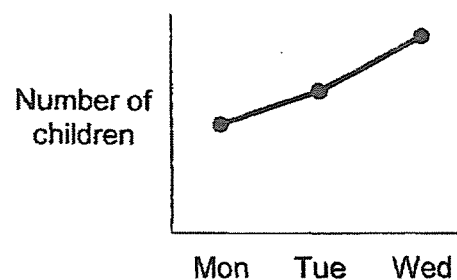

14 Abby reached the bus stop at 12.20 p.m. She waited 15 minutes for the bus and the bus journey was 40 minutes. What time did she reach her destination?

- (1) 01 15
- (2) 13 05
- (3) 13 15
- (4) 13 25

15 The difference between two numbers is 50. The smaller number is 300. What is the sum of the two numbers?

- (1) 250
- (2) 350
- (3) 550
- (4) 650

16 A flask contained 2 l of hot water. Ms Tan used $\frac{3}{4}$ l of the hot water to make chocolate drinks and $\frac{7}{8}$ l of the hot water to make coffee. How much water was left in the flask?

- (1) $\frac{3}{8}$ l
- (2) $1\frac{1}{4}$ l
- (3) $1\frac{5}{8}$ l
- (4) $3\frac{5}{8}$ l

(Go on to the next page)

17 Find the perimeter of the figure shown below. All the lines meet at right angles.

- (1) 68 cm
- (2) 120 cm
- (3) 136 cm
- (4) 864 cm

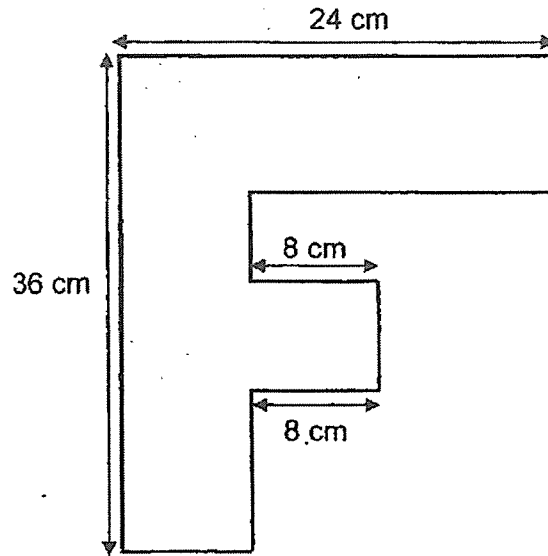

18 The figure below shows a photo frame that measures 30 cm by 22 cm.

A picture is mounted on the frame leaving a border of 1 cm around it.

Find the area of the picture.

- (1) 100 cm^2
- (2) 560 cm^2
- (3) 609 cm^2
- (4) 660 cm^2

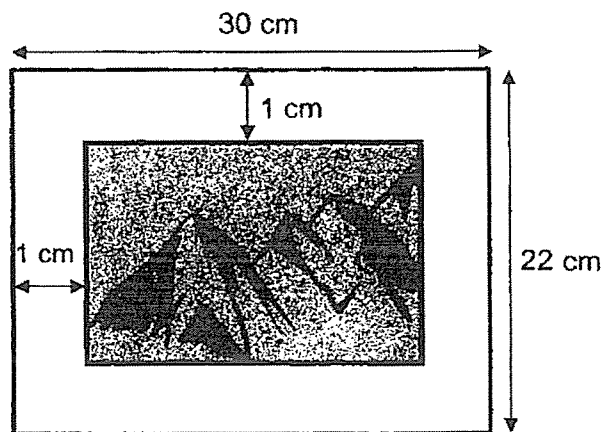

- 19 There are three electric stars on a Christmas tree. The three electric stars will light up every 3 minutes, 4 minutes, and 6 minutes respectively. The three electric stars are switched on and light up together for the 1st time at 10:00. What time will the electric stars light up together for the 3rd time?

- (1) 10:12
 (2) 10:13
 (3) 10:24
 (4) 10:26

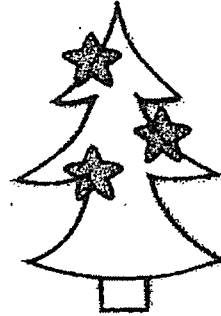

- 20 The table below shows the number of books read by 4A and 4B students in a week.

Number of storybooks	Number of students in 4A	Number of students in 4B
1	8	10
2	20	18
3	7	9

Which of the following statement(s) is true?

- X The total number of students in 4A is 35.
 Y The total number of books read by students in 4B is 37.
 Z The total number of books read by students in 4A is 69.
- (1) X only
 (2) X and Y
 (3) X and Z
 (4) Y and Z

(Go on to the next page)

Section B

Questions 21 to 40 carry 2 marks each. Show your working clearly and write your answers in the spaces provided. For questions which require units, give your answers in the units stated.

(40 marks)

21 Some factors of 12 are 1, 2, 3 and 12. What are the other two factors of 12?

Ans : _____ and _____

22 $4304 \div 8 =$ _____

Ans : _____

23 Write the missing number in the number pattern below.

32 400 , 32 000 , 31 600 , 31 200 , _____ , 30 400

Ans : _____

24 What fraction of the buttons shown are grey in colour?

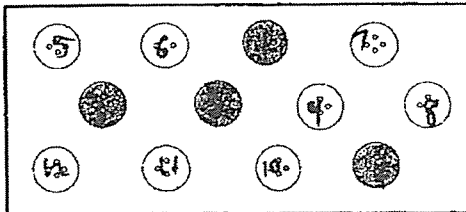

Ans : _____

Please do not write in the margin

25 Which two of the fractions below are in the simplest form?

$$\frac{2}{5}, \frac{3}{6}, \frac{4}{10}, \frac{5}{12}$$

Ans : _____ and _____

26 What is the value of $\frac{5}{9} + \frac{2}{3}$? Express your answer as a mixed number.

Ans : _____

27 $6.4 - 0.73 =$ _____

Ans : _____

28 Find the value of 4.72×6 .

Ans : _____

Please do not write in the margin

(Go on to the next page)

29 Write the decimal represented by A.

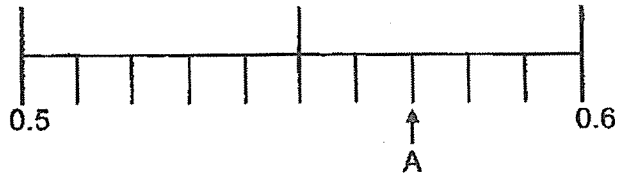

Ans : _____

30 Use a protractor and draw $\angle ABC = 100^\circ$ using the given line. Mark and label the point C.



Please do not write in the margin

31 The table below shows the times taken by four girls to complete a 100 m race.

Name	Amy	Bess	Cleo	Dawn
Time in seconds	16.1	17.0	15.8	15.9

Write down the names of the girls from the 1st to the 4th position.

Ans : _____ , _____ , _____ , _____
1st position *4th position*

32 In a factory, sweets are equally packed into boxes. Bill bought two boxes of sweets. He received 1044 sweets altogether. How many sweets would Bill receive in total, if he buys five more boxes of sweets?

Ans : _____

33 In the grid below, draw and label the square ABCD.
Lines AB and BC have been drawn for you.

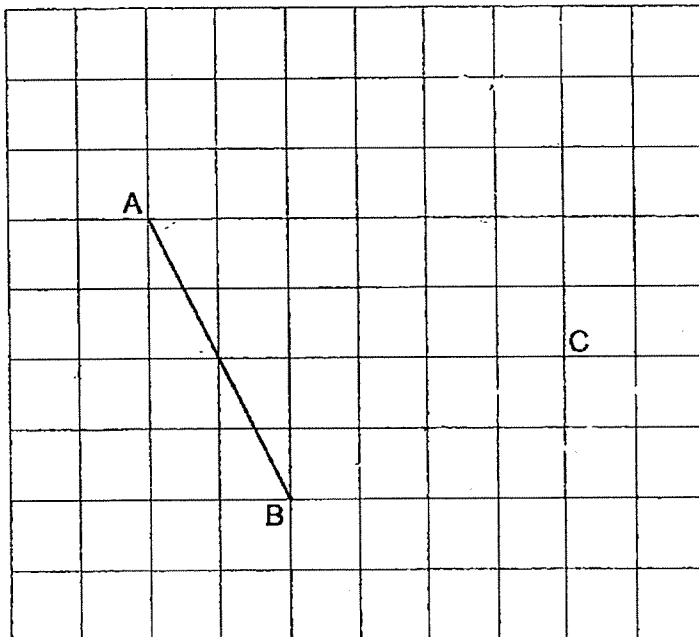

Please do not write in the margin



(Go on to the next page)

Use the information below to answer Questions 34 and 35.

Chocolates were sold at a candy shop last Monday. The line graph below shows the number of chocolates sold each hour, from 10 00 to 15 00.

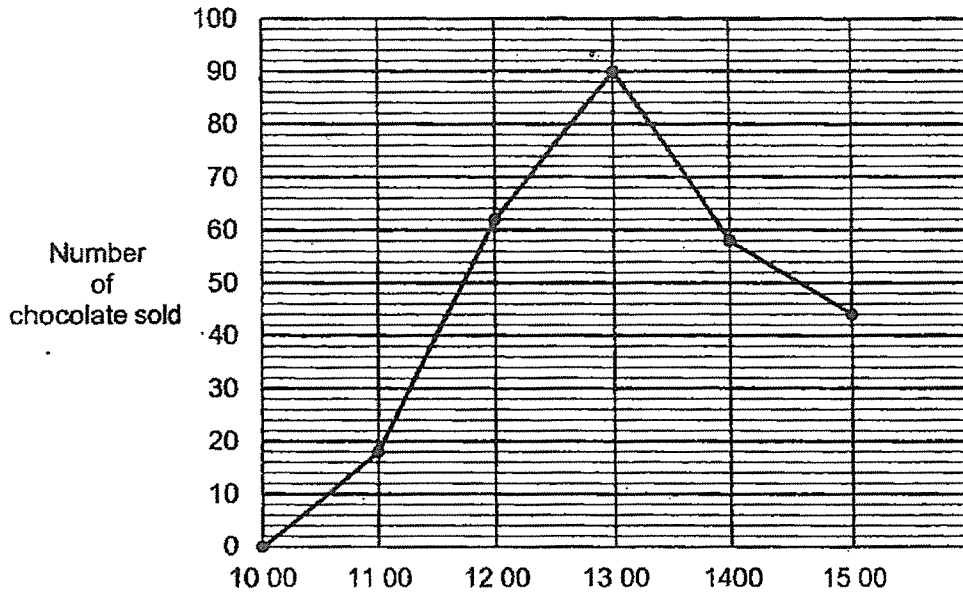

34 What was the total number of chocolates sold between 11 00 to 13 00?

Ans : _____

35 In which one-hour interval was the increase in the number of chocolates sold the greatest?

Ans : _____ to _____

Please do not write in the margin

36 The table below shows the total value of the coins in the piggy bank.
The graph below shows the number of coins in the piggy bank.

Label the bar graph by writing T for twenty-cent coins, F for fifty-cent coins and O for one-dollar coins in the boxes below.

Types of coins	Total Value
20 cents	\$ 2
50 cents	\$ 2
\$1	\$ 4

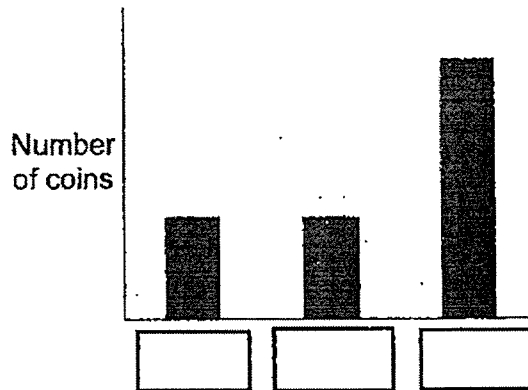

37 James took a flight from Singapore to Taiwan. The plane left Singapore 20 min before midnight and he arrived in Taiwan at 04 50.
What is the duration of the flight?

Ans : _____ h _____ min

38 A number is between 30 and 40. When it is divided by 3, the answer is a whole number. When it is divided by 4, the remainder is 3.
What is the number?

Ans : _____

Please do not write in the margin

(Go on to the next page)

39 At the school bookshop, the following stationeries are sold at the prices below.

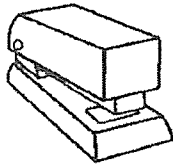

Stapler
\$5



Scissors
\$8



Ruler
\$3

Circle the correct options.

Bess spent a total of \$31 at the school book shop.

She bought 3 identical staplers/ scissors/ rulers
and 2 identical staplers/ scissors/ rulers

40 28 flags were placed around a square field at equal distance apart. The number of flags on each side of the field is the same. There is a flag at every corner of the field. Two of the flags are shown in the figure below.

How many flags are there on each side of the field?

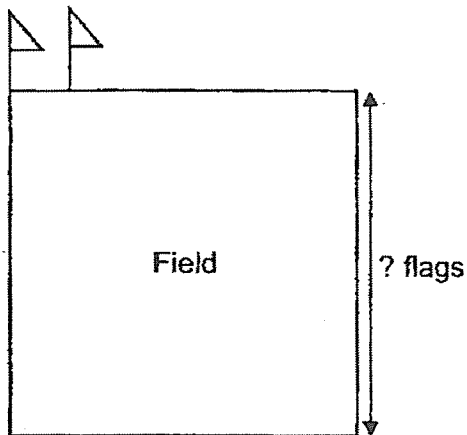

Ans : _____

Please do not write in the margin



Section C

For questions 41 to 46, show your working clearly and write your answers in the space provided. The number of marks available is shown in the brackets [] at the end of the question or part-question. (20 marks)

- 41 Bill is 4 times as heavy as Charlotte. He is 98.4 kg. What is the total mass of Bill and Charlotte?

Ans: _____ [3]

- 42 Ben had a piece of string. He cut it into three pieces, String A, String B and String C. String B is 0.15 m longer than String A and 2.7 m longer than String C. String A is 4.36 m long. What is the length of String C?

Ans: _____ [3]

Please do not write in the margin.

(Go on to the next page)

- 43 John had some money. He spent $\frac{1}{4}$ of his money on food and $\frac{5}{8}$ of his money on books. He spent \$12 more on books than food. How much money did he have at first?

Ans: _____ [3]

- 44 Ravi and Sam had 1780 stickers altogether. After Sam gave Ravi 40 stickers, they had the same number of stickers. How much stickers did Sam had at first?

Ans: _____ [3]

Please do not write in the margin



- 45 A television costs 10 times as much as a chair. 1 television and 1 table cost \$1820. 1 table and 1 chair cost \$560. What is the cost of 1 television and 2 tables?

Please do not write in the margin

Ans: _____ [4]



(Go on to the next page)

46 Mary was doing origami. She used a rectangular piece of paper as shown in Figure 1.

First, she folded one side as shown in Figure 2.

Next, she folded the paper upwards as shown in Figure 3. The area of the shaded part is 24 cm^2 .

What is the perimeter of the rectangular piece of paper as shown in Figure 1?

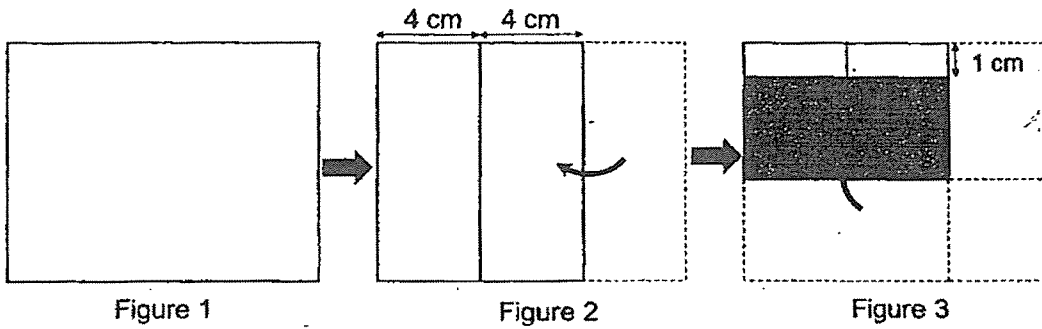

Please do not write in the margin

Ans: _____



End of Paper



SCHOOL : NAN HUA PRIMARY SCHOOL
LEVEL : PRIMARY 4
SUBJECT : MATHEMATICS
TERM : 2023 SA2

BOOKLET A

Q1	3	Q2	3	Q3	4	Q4	1	Q5	3
Q6	3	Q7	4	Q8	2	Q9	2	Q10	2
Q11	4	Q12	1	Q13	1	Q14	3	Q15	4
Q16	1	Q17	3	Q18	2	Q19	3	Q20	3

BOOKLET B

Q21	6 and 4
Q22	538
Q23	30 800
Q24	$\frac{1}{3}$
Q25	$\frac{2}{5}$ and $\frac{5}{12}$
Q26	$1\frac{2}{9}$
Q27	5.67
Q28	28.32
Q29	0.57
Q30	
Q31	Cleo, Dawn, Amy, Bess
Q32	$2U \rightarrow 1044$ $1U \rightarrow 1044 \div 2 = 522$

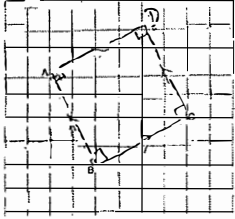
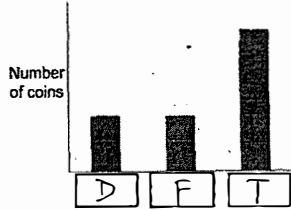
	$2+5=7$ $7U \rightarrow 7 \times 522 = 3654$ (Ans)
Q33	
Q34	$62 + 90 = 152$
Q35	1100 to 1200
Q36	
Q37	5 h 10 min
Q38	$39 \div 4 = 9 \text{ R}3$ ANS : 39
Q39	<div style="border: 1px solid black; padding: 10px; text-align: center;"> <p>She bought 3 identical staplers scissors/ rulers and 2 identical staplers scissors rulers</p> </div>
Q40	$28 \div 4 = 7$ $7 + 1 = 8$
Q41	$4U \rightarrow 98.4$ $1U \rightarrow 98.4 \div 4 = 24.6$ $5U \rightarrow 5 \times 24.6 = 123$
Q42	$4.36 + 0.15 = 4.51$ $4.51 - 2.71 = 1.81$ (Ans: 1.81 m)
Q43	$3U \rightarrow 12$ $1U \rightarrow 12 \div 3 = 4$ $8U \rightarrow 8 \times 4 = 32$ (Ans : \$32)

More Papers at

sgTestpapers.com

Q44	$1780 \div 2 = 890$ $8900 \div 10 = 890$ (Ans)
Q45	$9U \rightarrow 1820 - 560 = 1260$ $1U \rightarrow 1260 \div 9 = 140$ $560 - 140 = 420$ $420 \times 2 = 840$ $10U \rightarrow 10 \times 140 = 1400$ $1400 + 840 = 2240$ (Ans : \$2240)
Q46	$4 \times 3 = 12$ $4 \times 2 = 8$ $24 \div 8 = 3$ $3 \times 2 + 1 = 7$ $12 + 7 = 19$ $19 \times 2 = 38$ (Ans : 38 cm)

