

NANYANG PRIMARY SCHOOL
Term 1 Weighted Assessment
Science
Primary 3

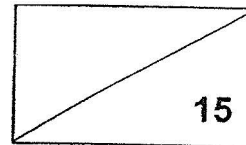

Name: _____ () Date: _____

Class: 3 _____ Parent's signature: _____









Dear Parent/Guardian,

Please sign the Weighted Assessment paper and have your child/ward return it the next day. Any query should be raised at the same time when returning the paper.

Section A: Multiple Choice Questions (10 marks)

For each question from 1 to 5, four options (1, 2, 3 and 4) are given. One of them is the correct answer. Indicate your choice in the brackets provided.

1. Study the following things in Group X and Group Y.

Group X		Group Y	
 grass	 millipede	 teddy bear	 hamburger
 monkey	 hibiscus plant	 car	 school bag

Which one of the following describes the things in the two groups **incorrectly**?

	Group X	Group Y
(1)	Can grow	Cannot grow
(2)	Can reproduce	Cannot reproduce
(3)	Respond to changes around them	Do not respond to changes around them
(4)	Do not need air, food and water to stay alive	Need air, food and water to stay alive

()

2. Emily found plant R in her garden. Plant R has fruits growing on it as shown in the diagram below.

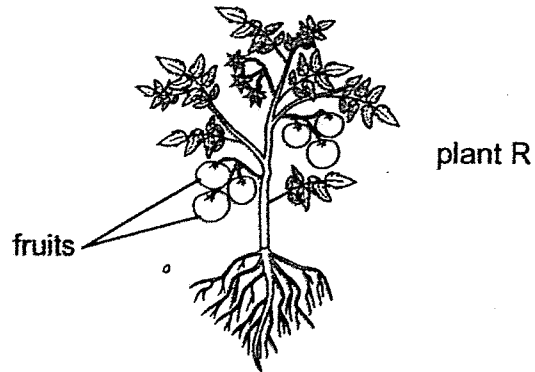

From her observation, which of the following statements about plant R are correct?

- A It is an adult plant.
- B It is a young plant.
- C It is a flowering plant.
- D It is a non-flowering plant.

(1) A and C only

(2) A and D only

(3) B and C only

(4) B and D only

()

3. Study the flowchart below.

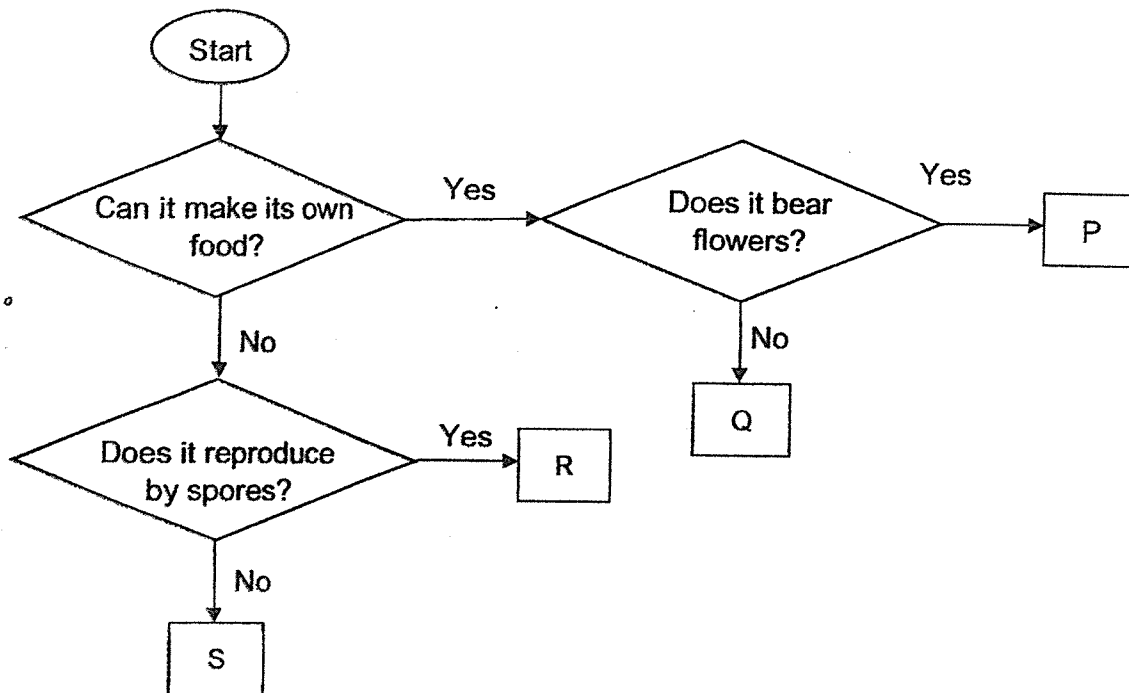

Based on the flowchart above, which one of the following statement is correct?

- (1) Q can bear fruits.
- (2) P is a flowering plant.
- (3) P, R and S are not plants.
- (4) Q and S reproduce by seeds.

()

4. The diagram below shows a classification chart of some living things.

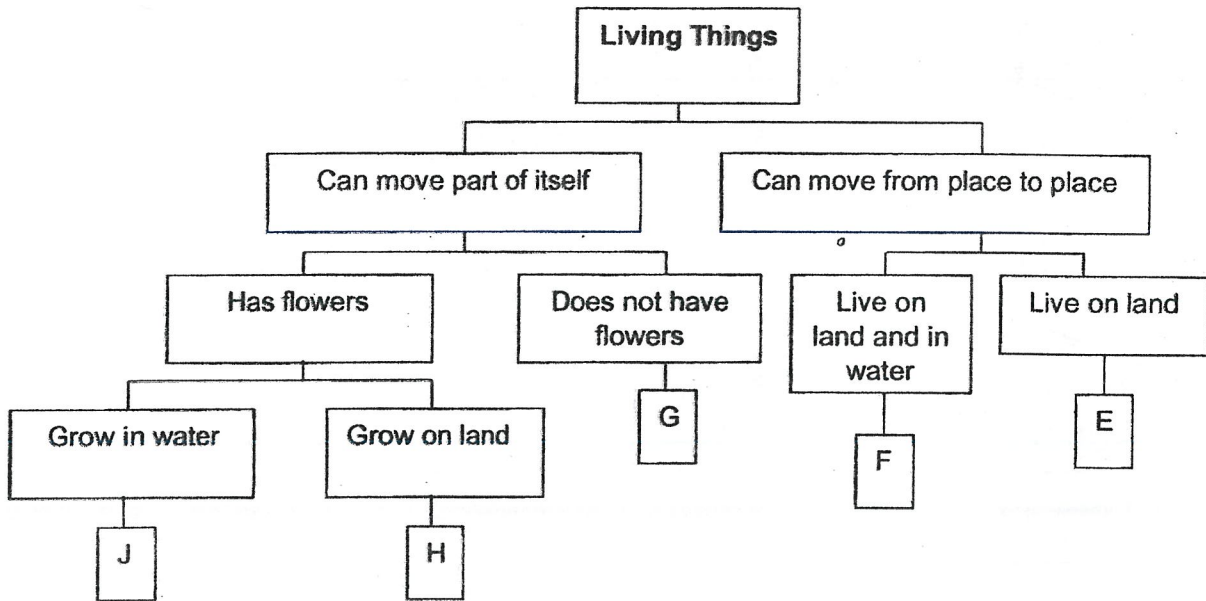

Which one of the following statements is correct?

- (1) G is not a plant.
- (2) Only F is an amphibian.
- (3) Only H and J are plants.
- (4) E can make its own food.

()

5. Meng Ho found animal S near a pond and observed it for a few days.

Which one of the following observations will help him conclude that animal S is definitely an amphibian?





- (1) Animal S lays eggs.
- (2) Animal S can swim.
- (3) Animal S has moist skin.
- (4) Animal S eats only animals.

()

Section B: Open-Ended Questions (5 marks)

For questions 6 and 7, fill in your answers in the spaces provided.

6. The classification table below shows how 4 different plants were classified.

Group A	Group B
 bird's nest fern	 ladder fern
	 rose plant
	 banana tree

(a) Give a suitable heading for each of the 2 groups of plants. [1]

Group A : _____

Group B : _____

(b) Write down a similar characteristic of living things between the ladder fern and the rose plant.

[1]

(c) Other than the headings used in (a), what is another difference between the plants in Group A and Group B? [1]

7. Study the flowchart below.

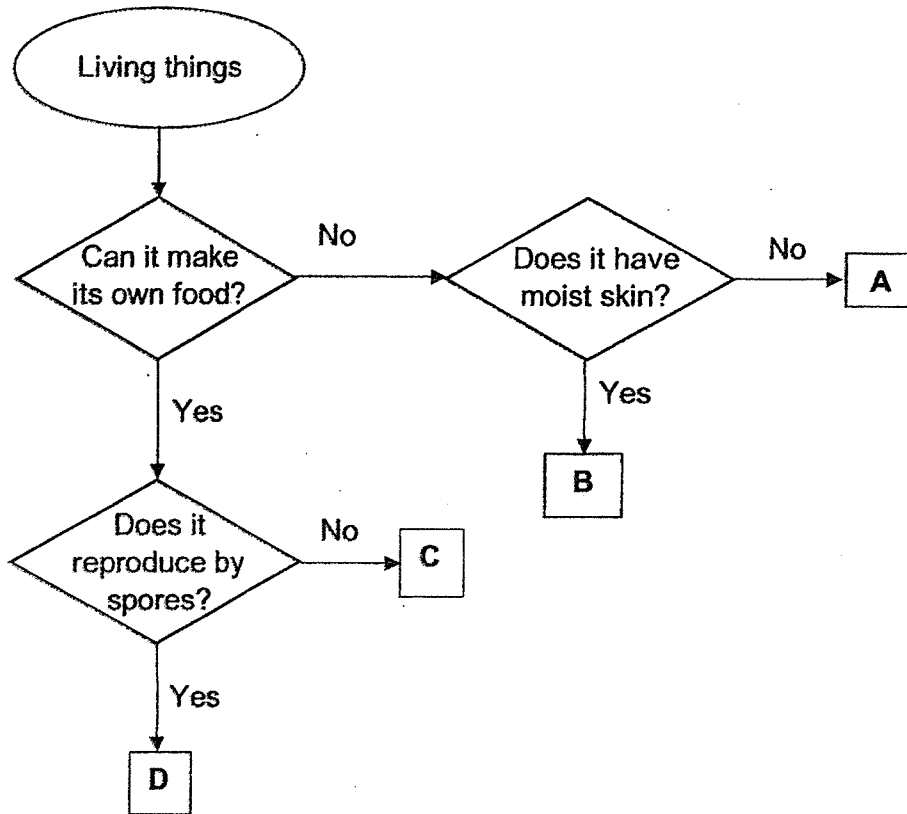

(a) Give an example of living thing D.

[1]

(b) Based on the flowchart above, state a difference between living thing B and living thing C.

[1]

- End of Paper -

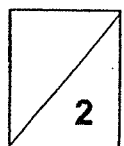

NANYANG PRIMARY SCHOOL
Term 2 Weighted Assessment
Science
Primary 3

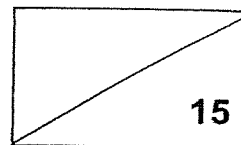

Name: _____ () Date: _____

Class: 3 _____ Parent's signature: _____

Dear Parent/Guardian,

Please sign the Weighted Assessment paper and have your child/ward return it the next day. Any query should be raised at the same time when returning the paper.

Section A: Multiple Choice Questions (10 marks)

For each question from 1 to 5, four options (1, 2, 3 and 4) are given. One of them is the correct answer. Indicate your choice in the brackets provided.

1. The table below shows the characteristics of animals X and Y. A tick (✓) indicates that the animal has that characteristic.

Characteristics	Animal X	Animal Y
Lays eggs	✓	✓
Breathes through gills	✓	
Has scales as outer covering	✓	
Has feathers as outer covering		✓

Based on the table above, which one of the following represents animals X and Y?

(1)	Animal X Amphibian	Animal Y Bird
(2)	Fish	Insect
(3)	Reptile	Amphibian
(4)	Fish	Bird

()

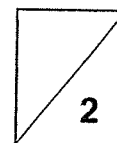

2. Study the classification chart below.

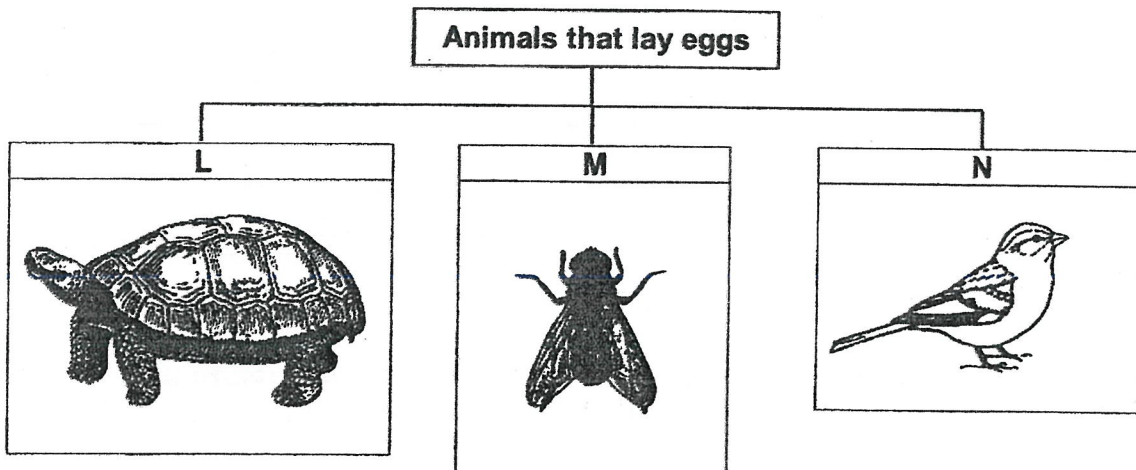

Based on the classification chart, which one of the following best represents L, M and N?

	L	M	N
(1)	Has dry scales as outer covering	Has a hard outer covering	Has feather as outer covering
(2)	Has moist scales as outer covering	Has dry scales as outer covering	Has hair as outer covering
(3)	Has moist scales as outer covering	Has a hard outer covering	Has hair as outer covering
(4)	Has dry scales as outer covering	Has dry scales as outer covering	Has feather as outer covering

()

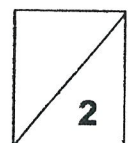

3. Which of the following statements about fungi and bacteria are correct?

- A: Mushroom is an example of a bacteria.
- B: All fungi and bacteria are microorganisms.
- C: Fungi and bacteria can be useful or harmful to humans.
- D: Fungi and bacteria feed on other organisms dead or alive.

- (1) A and B only
- (2) A and C only
- (3) B and D only
- (4) C and D only

()

4. The diagram below shows an electric drill. The part marked W is used to make holes in wooden planks.

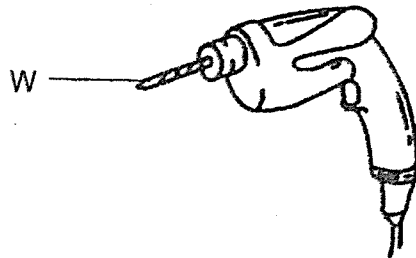

Which one of the following properties allows part W to perform this function well?

- (1) W is strong.
- (2) W is waterproof.
- (3) W sinks in water.
- (4) W does not allow light to pass through.

()

5. The diagram below shows a retort stand with a ruler attached to it.

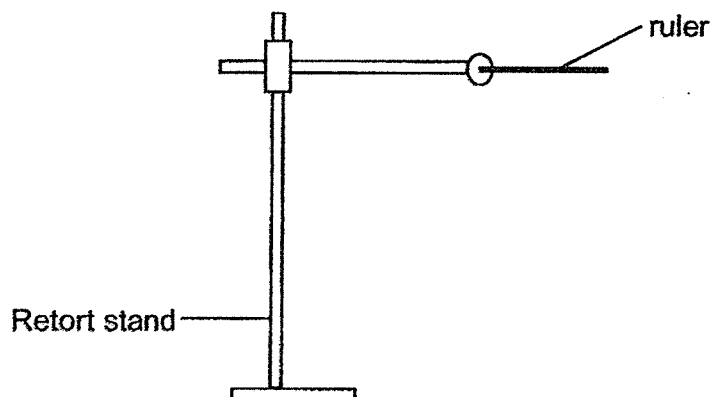

Jessica added weights to the ruler and observed how much the ruler can bend. The diagram below shows how the same ruler looked like after different weights were added.

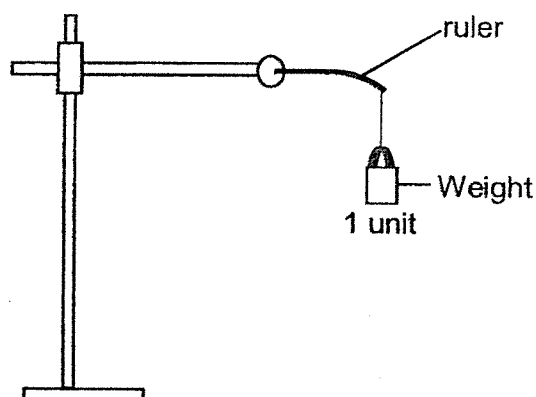
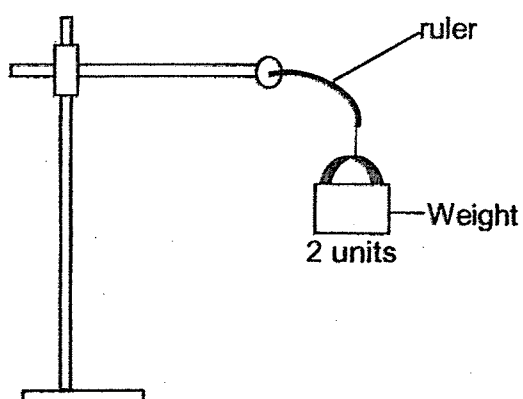

Which property of material is being tested in this experiment?

- (1) Strength
- (2) Flexibility
- (3) Waterproof
- (4) Allows light to pass through

()

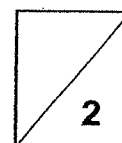

Section B: Open-Ended Questions (5 marks)

For questions 6 and 7, fill in your answers in the spaces provided.

6. The diagram below shows fungi and bacteria growing on food.

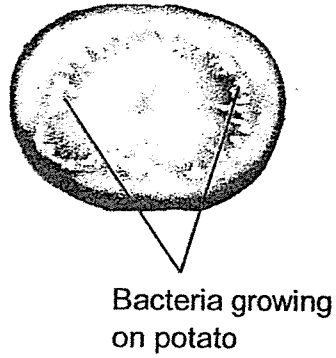
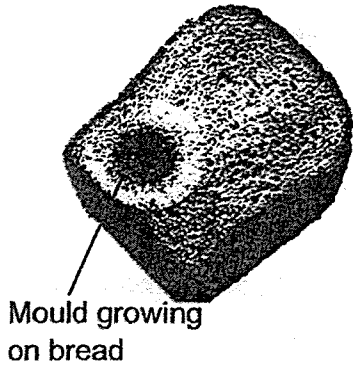

Fungi and bacteria will grow when the surrounding conditions are suitable.

(a) State three conditions that will allow fungi and bacteria to grow. [1]

(b) What can we do to the bread if we want to reduce the growth of fungi on it? [1]

7. Jenny set up an experiment as shown in the diagram below.

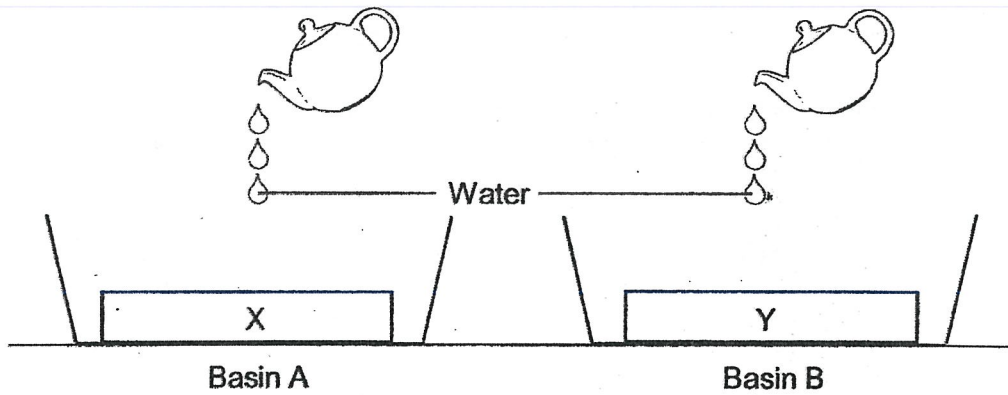

She poured equal amount of water over the materials, X and Y, and observed what happened.

The table below shows Jenny's observations of the two materials.

Material	Observations
X	Water slid off the material and is collected in basin A.
Y	Water is soaked up by the material. No water is collected in basin B.

(a) What property of material is Jenny trying to investigate? [1]

(b) Which material, X or Y, is more suitable for making a cleaning cloth? Explain your answer. [2]

- End of Paper -

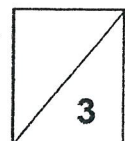

Nanyang Primary School
P3 SCIENCE WA1 2022

Section A

1	4
2	1
3	2
4	2
5	3

Section B

Qn No	Acceptable Answers
6. (a)	Group A: Non-Flowering Plants Group B: Flowering Plants
(b)	Both ladder fern and the rose plants can grow
(c)	Plants in Group A reproduce by spores but plants in Group B reproduce by seeds.
7. (a)	Bird's nest fern
(b)	Living thing C can make its own food <u>but</u> living thing B cannot make its own food.



Nanyang Primary School
P3 SCIENCE WA2 2022

Section A

1	4
2	1
3	4
4	1
5	2

Qn No	Acceptable Answers
6. a	Presence of air / oxygen, water, warmth, food
b	Store them in the fridge
7. a	To find out if the materials are waterproof or not.
b	Material Y because, it is not waterproff so that it can clean up water spillage.