

SINGAPORE CHINESE GIRLS' SCHOOL

FIRST SEMESTRAL ASSESSMENT 2021

PRIMARY 4

MATHEMATICS

BOOKLET A

Name : _____ ()

Parent's Signature

Class : Primary 4 SY/C/G/SE/P

There are 15 questions in this booklet.
SECTION A

Total Time : 1 h 45 min (Booklet A and B)

INSTRUCTIONS TO CANDIDATES

DO NOT OPEN THIS BOOKLET UNTIL YOU ARE TOLD TO DO SO.

FOLLOW ALL INSTRUCTIONS CAREFULLY.

ANSWER ALL QUESTIONS.

CHECK THAT ALL MCQ ANSWERS ARE SHADED CORRECTLY IN THE OAS

Section A: (30 marks)

Questions 1 to 15 carry 2 marks each. For each question, four options are given. One of them is the correct answer. Make your choice (1, 2, 3 or 4). Shade the correct oval (1, 2, 3 or 4) on the Optical Answer Sheet.

1. How many hundreds are there in 23 600?

- (1) 23
- (2) 236
- (3) 2360
- (4) 23 600

2. Which of the following numbers when rounded off to the nearest ten becomes 6700?

- (1) 6618
- (2) 6693
- (3) 6704
- (4) 6709

3. $81\ 369 = \underline{\hspace{2cm}} + 300 + 60 + 9$

- (1) 81
- (2) 810
- (3) 8100
- (4) 81 000

4. Name the angle below.

- (1) $\angle NMK$
- (2) $\angle MNK$
- (3) $\angle NLM$
- (4) $\angle MNL$

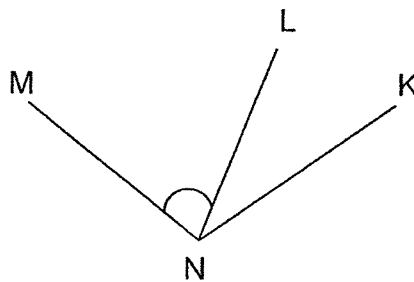

5. I am a number between 30 and 40. I am a multiple of 6.
What number am I?

- (1) 32
- (2) 36
- (3) 38
- (4) 39

6. In the figure shown below, not drawn to scale, PQRS is a rectangle.
Find $\angle d$.

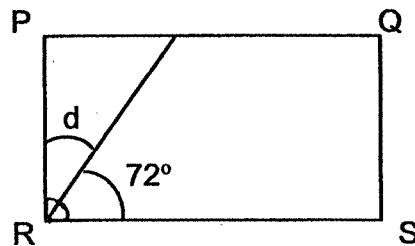

- (1) 18°
- (2) 28°
- (3) 45°
- (4) 108°

7. Ahmad was facing south-east. He made a $\frac{3}{4}$ turn in a clockwise direction.
Which direction would he be facing?

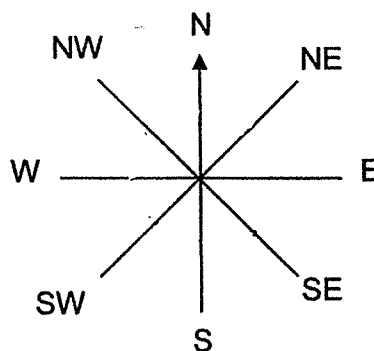

- (1) E
- (2) NE
- (3) SW
- (4) S

8. Molly had \$826. Sally had \$390. How much must Molly give Sally so that both of them have the same amount of money?

(1) \$218

(2) \$413

(3) \$436

(4) \$654

9. Divide 2 thousands by 4.

(1) 50

(2) 2

(3) 200

(4) 500

10. Express $3\frac{3}{4}$ as an improper fraction.

(1) $\frac{9}{4}$

(2) $\frac{10}{4}$

(3) $\frac{13}{4}$

(4) $\frac{15}{4}$

11. $\square + \frac{1}{6} + \frac{7}{12} = 1$

(1) $\frac{1}{4}$

(2) $\frac{1}{3}$

(3) $\frac{5}{9}$

(4) $\frac{5}{12}$

12. How many quarter turns does the minute hand make when it moves from 10.15 am to 11.30 am?

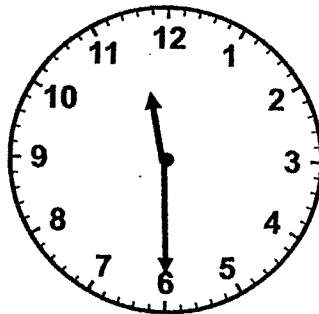
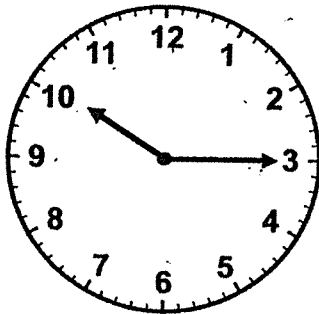

(1) 5

(2) 8

(3) 17

(4) 20

13. There are 476 eggs in a factory. $\frac{4}{7}$ of the eggs are duck eggs and the rest are chicken eggs. How many duck eggs are there?

- (1) 68
- (2) 204
- (3) 272
- (4) 357

14. Sally sewed 5 ribbons on each side of a square handkerchief as shown below. There was a ribbon on each corner. How many ribbons did she sew?

- (1) 12
- (2) 16
- (3) 17
- (4) 20

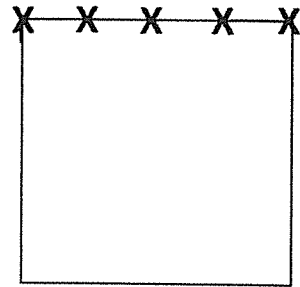

15. Mary has some money and Peter has \$12. When Mary gives Peter \$10, she has thrice as much as Peter. How much does Mary have now?

- (1) \$40
- (2) \$66
- (3) \$76
- (4) \$78

End of Booklet A

SINGAPORE CHINESE GIRLS' SCHOOL

FIRST SEMESTRAL ASSESSMENT 2021

PRIMARY 4

MATHEMATICS

BOOKLET B

Name : _____ ()

Class : Primary 4 SY/C/G/SE/P

		Marks attained	Max Mark
Booklet A	Section A		30
Booklet B	Section B		40
	Section C		30
Total			100

Parent's Signature

There are 28 questions in this booklet.
SECTIONS B and C

Total Time : 1 h 45 min (Booklet A and B)

INSTRUCTIONS TO CANDIDATES

DO NOT OPEN THIS BOOKLET UNTIL YOU ARE TOLD TO DO SO.
FOLLOW ALL INSTRUCTIONS CAREFULLY.
ANSWER ALL QUESTIONS.

Section B: (40 marks)

Questions 16 to 35 carry 2 marks each. Write your answers in the spaces provided. For questions which require units, give your answers in the units stated.

16. (a) Write 12 090 in words.

Ans : _____

(b) Write the following in numerals.

Seventy thousand, one hundred and eight.

Ans : _____

17. What are the numbers in the boxes below?

$$\frac{2}{3} = \frac{4}{6} = \frac{6}{9} = \frac{8}{\square} = \frac{\square}{15}$$

Ans : $\frac{8}{\square} = \frac{\square}{15}$

18. Find the difference between the 5th multiple of 7 and the 3rd multiple of 9.

Ans : _____

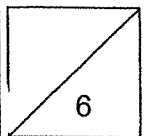

19. Find the value of 412×35 .

Do not write
in this column

Ans : _____

20. Sophie and Ahmad saved a total of \$1080. Sophie saved 5 times as much as Ahmad. How much did Ahmad save?

Ans : \$ _____

21. $\frac{1}{2} + \frac{4}{5} = \square$ Express your answer as a mixed number.

Ans : _____

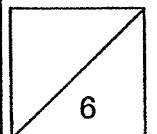

Do not write
in this column

22. Arrange the following fractions in decreasing order.

$$\frac{9}{8}, \frac{11}{5}, 1\frac{4}{7}, \frac{1}{2}$$

Ans : _____ , _____ , _____ , _____

23. What is the missing number in the box?

$$\begin{array}{r} \\ \\ \\ \\ \hline 1 \end{array}$$

Ans : _____

24. Find the total value of the angles in the rectangle below.

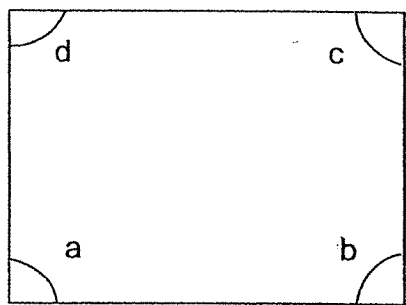

Ans : _____

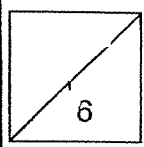

25. Line PQ is drawn for you. Draw $\angle PQR = 65^\circ$.
Label and mark $\angle PQR$.

Do not write
in this column

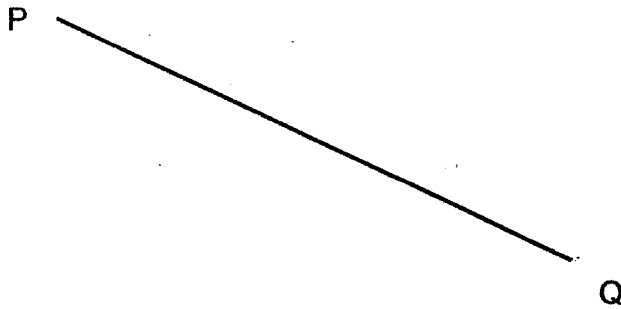

-
26. I am a two-digit even number.
I am between 20 and 30.
My factors include 2 and 8.
What number am I?

Ans : _____

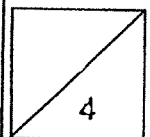

Do not write
in this column

27. Sally goes to the fitness centre every 4 days and Devi goes to the fitness centre every 6 days. Both of them were at the same fitness centre on 1 June. When will both of them meet each other at the fitness centre again?

2021 JUNE						
SUNDAY	MONDAY	TUESDAY	WEDNESDAY	THURSDAY	FRIDAY	SATURDAY
		1	2	3	4	5
6	7	8	9	10	11	12
13	14	15	16	17	18	19
20	21	22	23	24	25	26
27	28	29	30			

Ans : _____ June

28. Draw the missing lines of the rectangle.

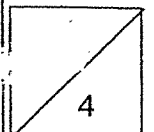
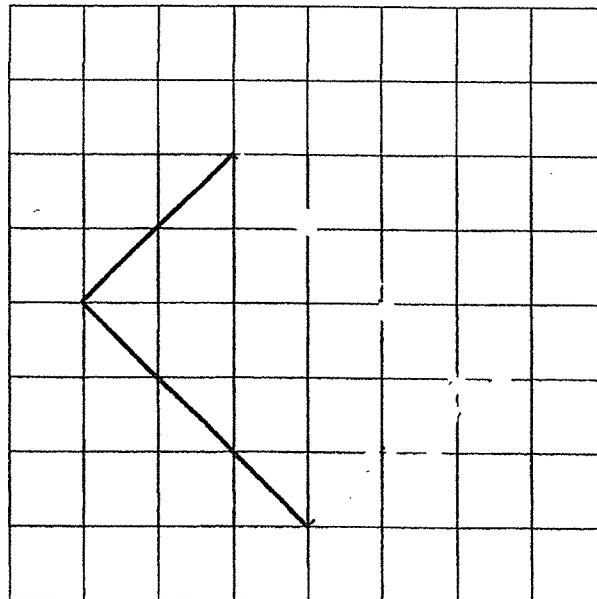

29. Mary spent $\frac{4}{9}$ of her money and had \$15 left.

How much money did she have at first?

Ans : _____

30. ABCD is a rectangle. $\angle BDE = 48^\circ$. Find the value of $\angle CDE$.

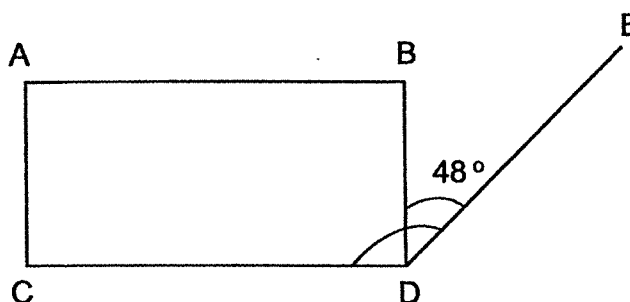

Ans: _____°

31. There were 289 adults at a funfair. The number of children was thrice the number of adults. How many children were at the funfair?

Ans : _____

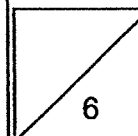

32. Peter had \$100 more than John at first. After John had spent \$40, Peter had thrice as much money as John. How much money did John have at first?

Ans : _____

33. Mr Tan had 5 kg of flour. He used $\frac{3}{10}$ kg to bake cookies.

How much flour had he left?

Ans : _____ kg

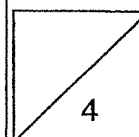

34. Measure $\angle y$.

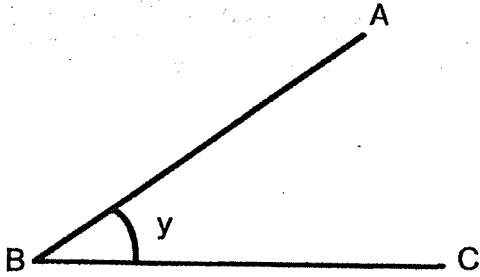

Ans : $\angle y =$ _____ $^{\circ}$

35. Tick each property of a square and a rectangle.
The first one has been done for you.

Properties	Square	Rectangle
It has 4 sides.	✓	✓
It has 4 equal sides.		
It has 2 short sides and 2 long sides.		

End of Booklet B

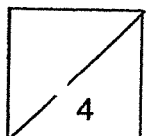

Section C: (30 marks)

For questions 36 to 43, show your working clearly in the space provided for each question and write your answer in the space provided. The number of marks available is shown in brackets [] at the end of each question or part-question.

36. Kelly saved \$175 each month.
She saved the same amount of money for 11 months.
Then she gave \$880 to her mother. How much money had Kelly left?

Ans: _____ [3]

37. Mrs Lim drank $\frac{5}{8}$ l of water in the morning.
In the afternoon, she drank $\frac{1}{2}$ l more water than in the morning.
How many litres of water did she drink altogether for that day?
Express your answer as a mixed number.

Ans : _____ [3]

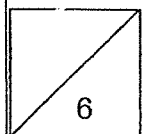

38. There were 2500 students in a school. There were 1455 girls.
- a) How many boys were there in the school?
 - b) What was the difference between the number of girls and boys in the school?

Ans : a) _____ [2]

b) _____ [2]

-
39. Mrs Wong had \$200. She spent \$25 on transport and some money on food.
She then had \$75 left.
- What fraction of her money was spent on food?
Express your answer in its simplest form.

Ans: _____ [4]

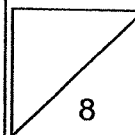

Adult ticket	Child ticket
\$70	Half price

40. The table above shows the admission ticket prices for adults and children at Universal Studios.

A group of 6 adults and 6 children went to Universal Studios.

How much did they pay for their admission tickets?

Ans: _____ [4]

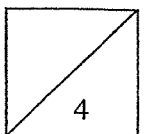

Do not write
in this column

41. On Monday, Mike and Ali sold 2008 tickets altogether.
On Tuesday, Ali sold 302 tickets while Mike did not sell any.
In total, Mike sold 5 times as many tickets as Ali.
How many tickets did Ali sell on Monday?

Ans: _____ [4]

42. Mr Wong went to the market with some money. He spent $\frac{1}{5}$ of it on vegetables,
 $\frac{1}{2}$ of it on fish and had \$72 left. How much money did he have at first?

Ans: _____ [4]

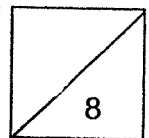

43. Penny bought 5 notebooks and 7 files. With the same amount of money, she could buy 7 notebooks exactly.

One file cost \$4. How much did one notebook cost?

Ans: _____ [4]

END OF PAPER

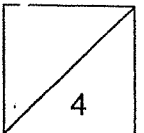

Q34	35	Q35	Square Rectangle
Q36	$175 \times 11 = 1925$ $1925 - 880 = \$1045$	Q37	$\frac{5}{8} + \frac{4}{8} = \frac{9}{8}$ $1\frac{1}{8} + \frac{5}{8} = 1\frac{3}{4}$
Q38	(a) $2500 - 1455 = 1045$ (b) $1455 - 1045 = 410$	Q39	$75 + 25 = 100$ $200 - 100 = 100$ $\frac{100}{200} = \frac{1}{2}$
Q40	$70 \div 2 = 35$ $70 \times 6 = 420$ $35 \times 6 = 210$ $420 + 210 = \$630$	Q41	$2008 + 302 = 2310$ $2310 \div 6 = 385$ $385 - 302 = 83$
Q42	$72 \div 3 = 24$ $24 \times 10 = \$240$	Q43	$7 \times 4 = 28$ $28 \div 2 = \$14$

D
END