

**First Semestral Assessment 2017
Primary 5 Mathematics**

Name: _____

Register No. _____

Class: Pr 5 - _____

Date: 8 May 2017

Parent's Signature: _____

Total Time for Booklets A and B : 1 hour

**PAPER 1
(Booklet A)**

Instructions to Pupils:

1. Do not open this booklet until you are told to do so.
2. Follow all instructions carefully.
3. Shade your answers in the Optical Answer Sheet (OAS) provided.
4. You are **not** allowed to use a calculator.
5. Answer all questions.

Section	Maximum Mark	Marks Obtained
Paper 1 (Booklet A)	20	

* This booklet consists of 7 pages (including this cover page)

Questions 1 to 10 carry 1 mark each. Questions 11 to 15 carry 2 marks each.
For each question, four options are given. One of them is the correct answer.
Make your choice (1, 2, 3 or 4). Shade the oval (1, 2, 3 or 4) on the Optical Answer Sheet.

All diagrams in this paper are not drawn to scale unless stated otherwise.

(20 marks)

1. Express 3090 cm in metres.

- (1) 3.09 m
- (2) 3.90 m
- (3) 30.09 m
- (4) 30.90 m

2. Find the value of $16 + (22 - 10) \div 2 \times 3$

- (1) 18
- (2) 34
- (3) 42
- (4) 84

3. Which of the following is seven hundred and seven thousand and seventeen in figures?

- (1) 707 017
- (2) 717 070
- (3) 770 017
- (4) 770 070

4. During a sale, the number of shopping vouchers sold on Sunday was 23 000 when rounded off to the nearest thousands. Which one of the following could be the actual number of shopping vouchers sold on that day?

- (1) 22 498
- (2) 22 502
- (3) 23 541
- (4) 23 589

5. What does the digit 4 in 9.254 stand for?

- (1) 4 ones
- (2) 4 tenths
- (3) 4 hundredths
- (4) 4 thousandths

6. In the number line below, what is the value of X?



- (1) 36
- (2) 38
- (3) 39.6
- (4) 39.8

7. Which of the following fractions is the smallest?

- (1) $\frac{5}{7}$
- (2) $\frac{5}{6}$
- (3) $\frac{5}{9}$
- (4) $\frac{5}{8}$

8. $1\frac{7}{12} = \boxed{?} + \frac{1}{6}$

What is the missing fraction in the box?

(1) $\frac{5}{12}$

(2) $\frac{9}{12}$

(3) $\frac{17}{12}$

(4) $\frac{21}{12}$

9. Which of the following letters is symmetric?

Q R Y Z

(1) Q

(2) R

(3) Y

(4) Z

10. The graph below shows the number of toys sold by a shop from April to August.

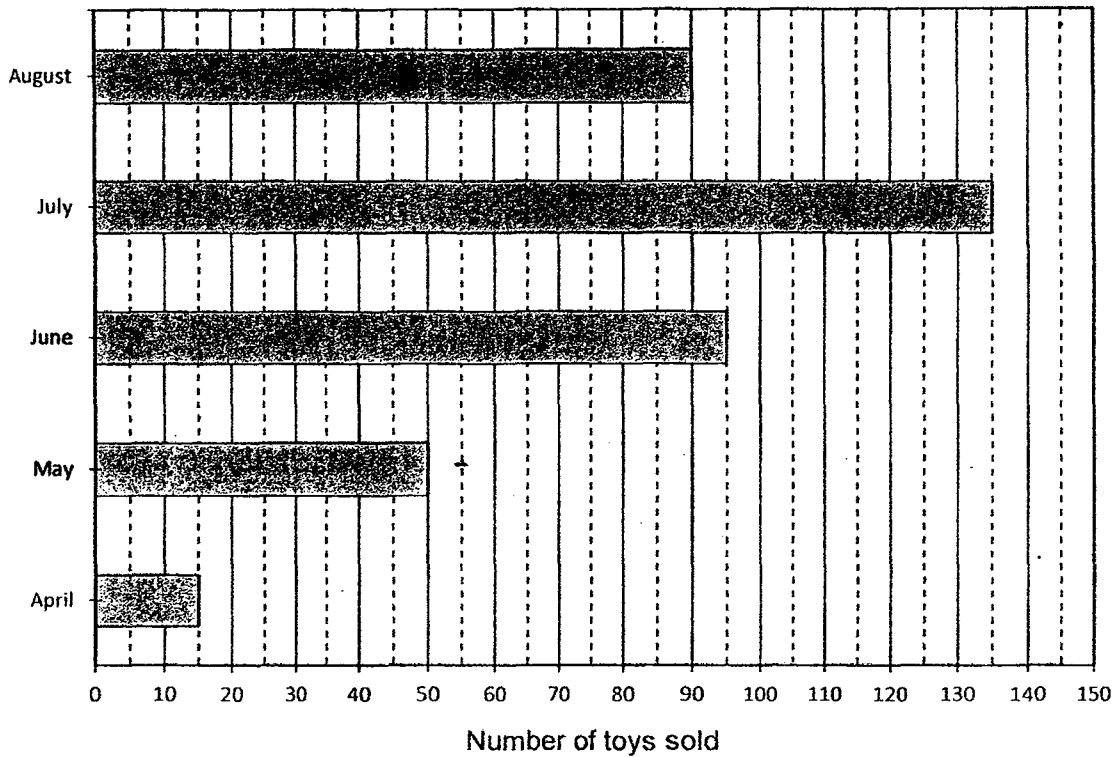

Between which 2 months was there the greatest increase in the number of toys sold?

- (1) April to May
 - (2) May to June
 - (3) June to July
 - (4) July to August
11. Andrew used $\frac{9}{10}$ kg of flour to bake some cookies and muffins. He used $\frac{1}{6}$ of it to bake cookies. How much flour did he use to bake muffins?

- (1) $\frac{3}{4}$ kg
- (2) $\frac{1}{15}$ kg
- (3) $\frac{11}{15}$ kg
- (4) $\frac{3}{20}$ kg

12. Mrs Wong bought some durian, chocolate, vanilla puffs for a party. $\frac{1}{4}$ of them were durian puffs. There were 24 chocolate puffs and 66 vanilla puffs. How many puffs did Mrs Wong buy altogether?
- (1) 56
(2) 120
(3) 168
(4) 360
13. Paul bought 5 files at \$1.60 each and a book for \$3.80. If he had \$2.40 left, how much did he have at first?
- (1) \$7.80
(2) \$9.40
(3) \$12.80
(4) \$14.20
14. Mrs Tan bought 1.2 kg of sugar. She used 180 g for cooking and packed the remaining sugar into packets of 60 g each. How many packets of sugar did she have?
- (1) 14
(2) 17
(3) 20
(4) 23

15. The table below shows the results of 80 participants who took part in a quiz. They must obtain at least a certain score in the first round to qualify for the second round.

Points scored	Number of participants
0	11
1	12
2	17
3	10
4	13
5 or more	17

Half the participants did not qualify for the second round. What is the lowest number of points a participant needs to score to qualify for the second round?

- (1) 5
- (2) 2
- (3) 3
- (4) 4

**First Semestral Assessment 2017
Primary 5 Mathematics**

Name: _____

Register No. _____

Class: Pr 5 - _____

Date: 8 May 2017

Parent's Signature: _____

Total Time for Booklets A and B : 1 hour

**PAPER 1
(Booklet B)**

Instructions to Pupils:

1. Do not open this booklet until you are told to do so.
2. Follow all instructions carefully.
3. You are **not** allowed to use a calculator.
4. Write your answers in the booklet.
5. Answer all questions.

Section	Maximum Mark	Marks Obtained
Paper 1 (Booklet B)	25	

* This booklet consists of **8** pages (including this cover page).

Questions 16 to 20 carry 1 mark each. Write your answers in the spaces provided. For questions which require units, give your answers in the units stated.

All diagrams in this paper are not drawn to scale unless stated otherwise.
(5 marks)

Do not write
in this space

16. Ahmad made some lemonade by adding 1 ℓ of water and 40 ml of lemon juice into a container. He then poured it equally into 4 cups. How many millilitres of lemonade were there in each cup?

Ans: _____ ml

17. How much water is there in the beaker?

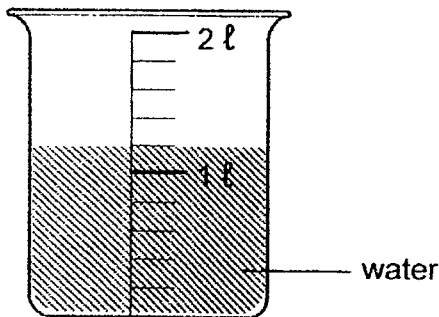

Ans: _____ ml

18. Express $8\frac{3}{4}$ as a decimal.

Ans: _____

19. James was facing the MRT station at first. He turned 135° clockwise. Where would he be facing now?

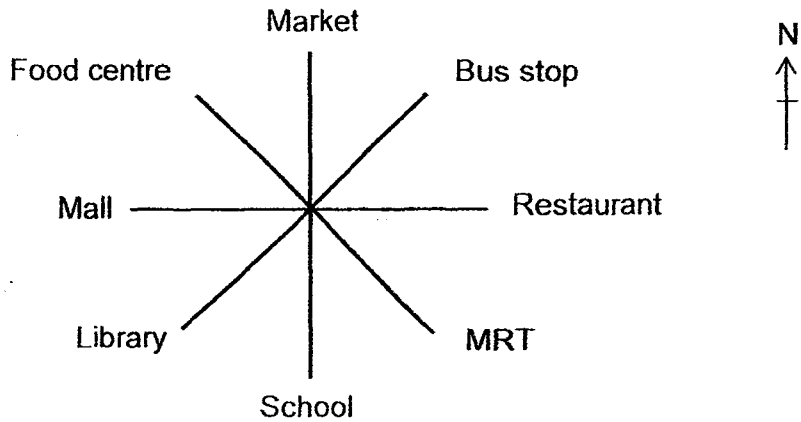

Ans: _____

Do not write
in this space

20. The table below shows the number of rainy days in Singapore from January to April. Find the number of rainy days in January.

Month	Rainy Days
January	?
February	13
March	17
April	21
Average for the 4 months	15

Ans: _____

Questions 21 to 30 carry 2 marks each. Show your workings clearly in the space provided for each question and write your answers in the spaces provided. For questions which require units, give your answers in the units stated.

Do not write
in this space

All diagrams in this paper are not drawn to scale unless stated otherwise.

(20 marks)

21. Arrange the following numbers in order, beginning with the greatest.

$$9.540, 9\frac{54}{1000}, 9.405, 9\frac{9}{20}$$

Ans: _____, _____, _____, _____
greatest

22. Carolyn had 18 red pens and Tina had 15 green pens.
Each of them packed their own pens equally into smaller bags.
Carolyn and Tina discovered that they had packed the same number of pens in each bag. How many bags of pens did Carolyn have?

Ans: _____

23. Tank A contained 3 times as much water as Tank B. After 12.36 ℓ of water was poured from Tank A into Tank B, both tanks had the same amount of water. How many litres of water were there in Tank A at first?

Do not write in this space

Ans: _____ ℓ

24. Jack baked 120 cookies. He ate 12 cookies and gave $\frac{5}{9}$ of the remaining cookies to his cousin. How many cookies did his cousin get?

Ans: _____

25. How many more squares must be shaded so that $\frac{3}{8}$ of the figure is shaded?

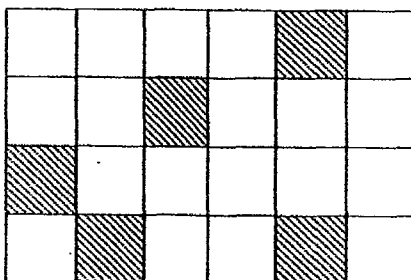

Ans: _____

26. The figure below is made up of a square ABCD and 2 identical rectangles, EFGC and HIJG. Given that AD = 5 cm, IJ = 8 cm, and HI = 2 cm, find the perimeter of the figure.

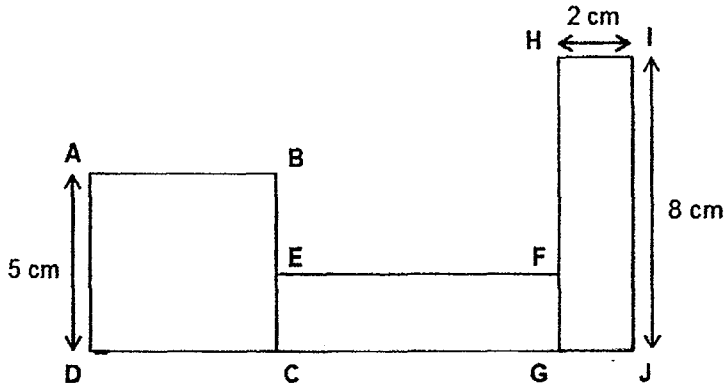

Do not write in this space

Ans: _____ cm

27. Study the diagram below.
 (a) Name a pair of perpendicular lines
 (b) Name a pair of parallel lines.

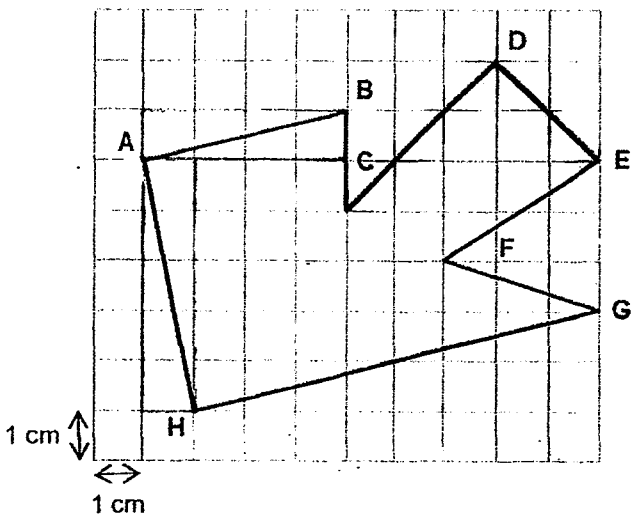

(a) Ans: _____ \perp _____

(b) Ans: _____ \parallel _____

28. Using line PQ drawn below, draw and label $\angle PQR = 130^\circ$.

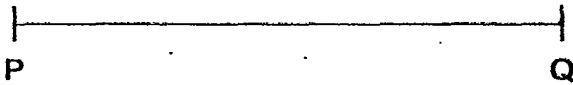

Do not write
in this space



29. The cost of 2 printers and 3 ink cartridges is \$420.
The cost of 3 ink cartridges is equal to the cost of 1 printer.
Find the cost of a printer.

Ans: \$ _____



30. Rachel had 90 fifty-cent coins. Ivan had $\frac{3}{5}$ of the number of fifty-cent coins Rachel had. How much money did Ivan have?

Do not write
in this space

Ans: _____



End of paper
Have you checked your work?

**First Semestral Assessment 2017
Primary 5 Mathematics**

Name: _____ Register No. _____

Class: Pr 5 - _____

Date: 8 May 2017 Parent's Signature: _____

Time: 1 h 30 min

PAPER 2

Instructions to Pupils:

1. Do not open this booklet until you are told to do so.
2. Follow all instructions carefully.
3. **Show your workings clearly** as marks are awarded for correct working.
4. Write your answers in this booklet.
5. You are allowed to use a calculator.
6. Answer all questions.

Questions	Maximum Mark	Marks Obtained
Q 1 to 5	10	
Q 6 to 17	45	

Section	Maximum Mark	Marks Obtained
Paper 1	45	
Paper 2	55	
Total	100	

*** This booklet consists of 14 pages (including this cover page)**

This paper is not to be reproduced in part or whole without the permission of the Principal.

Questions 1 to 5 carry 2 marks each. Show your working clearly in the space provided for each question and write your answers in the spaces provided. For questions which require units, give your answers in the units stated.

Do not write in this space

All diagrams in this paper are not drawn to scale unless stated otherwise.

(10 marks)

1. Elizabeth paid \$495 for a skirt and 3 similar blouses. The skirt cost twice as much as 1 blouse. How much did the skirt cost?

Ans: \$ _____

2. In the figure below, find $\angle DEF$.

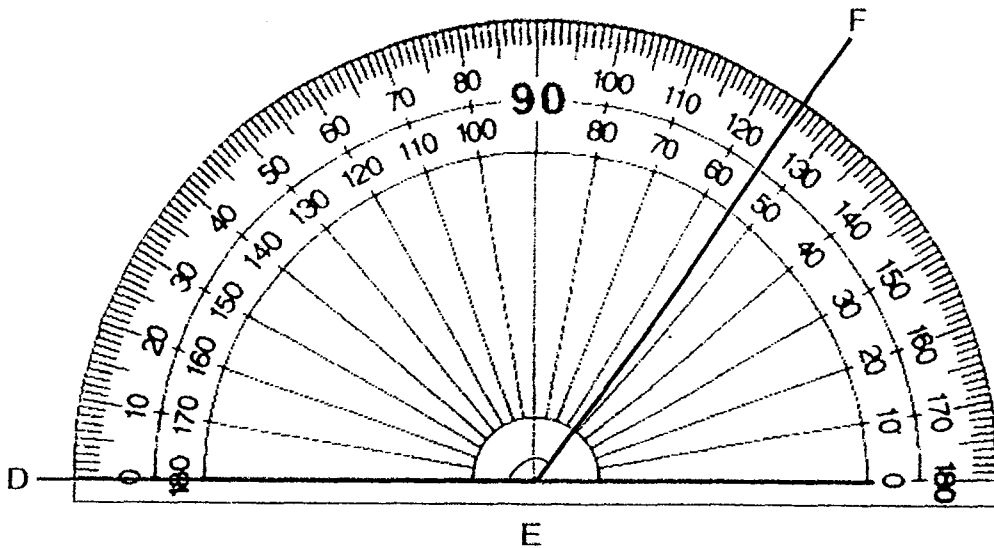

Ans: _____ °

3. Class 5A did a survey on the number of fruit servings each pupil in the school ate during recess for a week. Results of the survey are shown in the bar graph below.

Do not write in this space

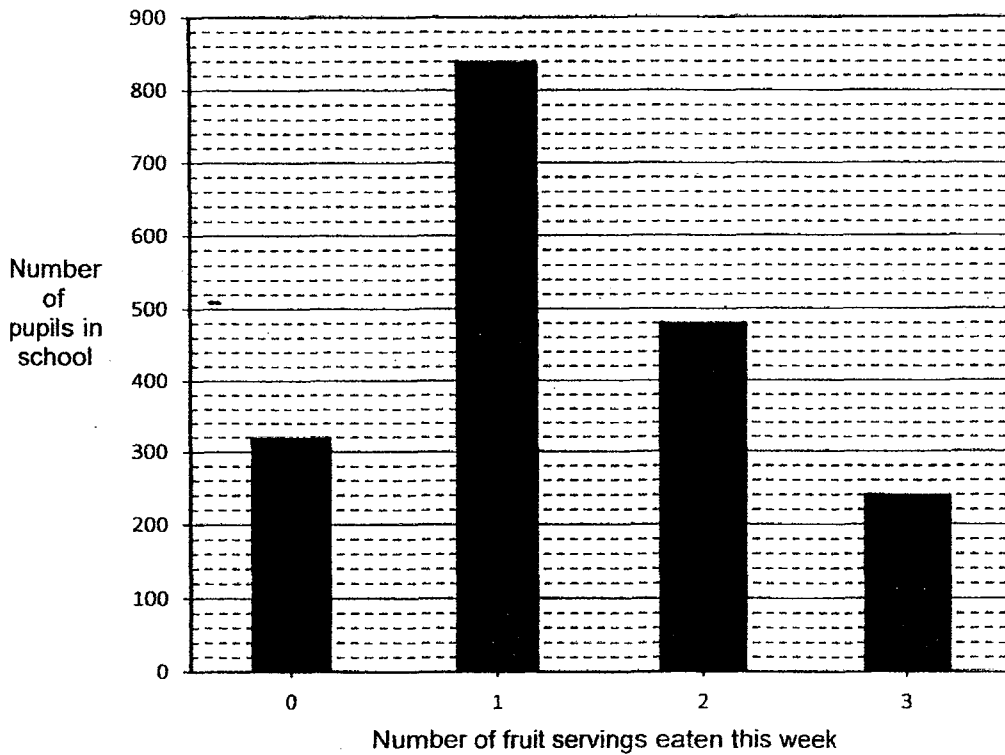

Each statement below is either true, false or not possible to tell from the information given. For each statement, put a tick (✓) in the correct column.

	Statement	True	False	Not possible to tell
a)	At least half the pupils in school ate more than 1 fruit.			
b)	Most of the pupils did not eat any fruits this week.			



4. A bakery sells biscuits at a cost of \$7 per packet.
John has \$26. What is the maximum packets of biscuits John can buy?

Do not write
in this space

Ans: _____

-
5. The price of a table is \$420. The price of a chair is $\frac{2}{5}$ of the price of a table.
How much did Father pay for a table and a chair in total?

Ans: \$ _____

For Questions 6 to 17, show your working clearly in the space provided for each question and write your answers in the spaces provided. The number of marks available is shown in brackets () at the end of each question or part-question. For questions which require units, give your answers in the units stated.

Do not write
in this space

All diagrams in this paper are not drawn to scale unless stated otherwise.

(45 marks)

6. Jane had 70 marbles. $\frac{4}{7}$ of her marbles were green and the rest were red and blue. She had 16 more red marbles than blue marbles. How many red marbles did she have?

Ans: _____ [3]

7. There are more than 38 members in a Chess club. If the pupils are grouped into groups of 6, there will be 2 extra pupils. If they are grouped into groups of 5, there will be 3 extra pupils. If the maximum number of members is 90, how many members were there in the Chess club?

Ans: _____ [3]

Do not write
in this space

8. Betty had some sweets for sale. She sold $\frac{3}{7}$ of the sweets and gave $\frac{5}{8}$ of the remainder to her brother. She had 780 sweets left. How many sweets did she have at first?

Ans: _____ [3]

-
9. Susan bought some books from a bookshop. If she wanted to buy 9 books, she would be short of \$21.75. If she wanted to buy 4 books, she would have \$17.50 left. How much money did Susan have at first?

Ans: _____ [3]

10. The figure below shows a rectangular pond surrounded by 26 identical square tiles. The perimeter of a square tile is 180 cm. Find the shaded area of the rectangular pond

Do not write
in this space

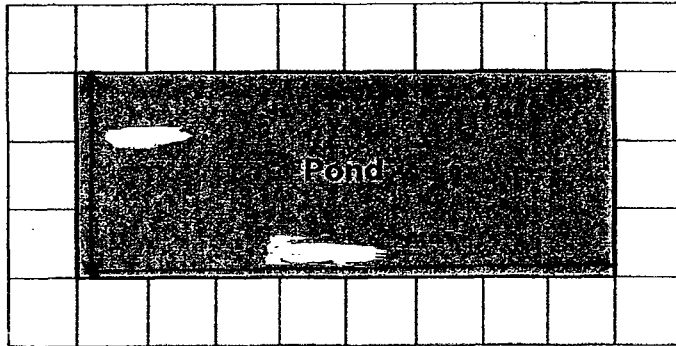

Ans: _____ [3]



11. Daniel had 45 marbles and Jane had 185 marbles. Their father gave each of them an equal number of marbles. After that, Jane had three times as many marbles as Daniel.

(a) How many marbles did their father give to Daniel?

(b) In the end, how many marbles did the children have altogether?

Do not write
in this space

Ans: (a) _____ [3]

(b) _____ [1]

12. The mass of a tin which is $\frac{7}{9}$ filled with rice is 540 g.

After some rice is removed, the tin became $\frac{1}{9}$ filled with rice.

The mass of the tin of rice now is 210 g. Find the mass of the empty tin.

Do not write
in this space

Ans: _____ [4]



13. The table below shows the lengths of red string and blue string needed to tie a parcel. Jamie used 8 more pieces of red string than blue string. If the total length of red string and blue string used was 65.9 m, how many pieces of red string did she use?

Do not write
in this space

Red string (1 piece)	Blue string (1 piece)
1.3 m	2.4 m

Ans: _____ [4]

14. The average height of 7 pupils is 142 cm. When David and Ahmad's height are included, the average height of the pupils becomes 144 cm. Ahmad is 34 cm shorter than David. What is Ahmad's height in metres?

Do not write
in this space

Ans: _____ [4]

15. Alice and Bella went shopping with a total of \$480. After Alice spent $\frac{1}{3}$ of her money and Bella spent \$95, the amount of money Bella had left was four times that of what Alice has left. How much more money did Bella bring along for shopping than Alice?

Do not write
in this space

Ans: _____ [4]



Do not write
in this space

16. James had a bag filled with 20¢ and 50¢ coins. There are 32 more 20¢ coins than 50¢ coins. The value of all the 50¢ coins is \$28.40 more than the value of all the 20¢ coins.

- (a) How many 20¢ coins are there in the bag?
- (b) James needs more money to buy a shirt that costs \$89.20. How much more money does he need?

Ans: (a) _____ [3]

(b) _____ [2]

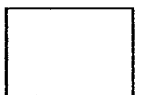

17. Hazim spent $\frac{1}{5}$ of his money and an additional \$6 on a book. He then spent $\frac{3}{7}$ of his remaining money and an additional \$14 on a bag. He then spent \$9 on food and had \$25 left. How much money did Hazim have at first?

Do not write
in this space

Ans: _____ [5]

End of paper
Have you checked your work?

School: Rosyth
 Level: P5
 Subject: Maths
 Term: SA1
 Year: 2017

Q1	Q2	Q3	Q4	Q5
4	2	1	2	4
Q6	Q7	Q8	Q9	Q10
3	3	3	3	2
Q11	Q12	Q13	Q14	Q15
1	2	4	2	3

- Q16) 260 ml Q17) 1200 ml Q18) 8.75 Q19) Mall Q20) 9
 Q21) 9.54, $9\frac{9}{20}$, 9.405, $9\frac{54}{1000}$ Q22) 6 bags of pens Q23) 37.08l Q24) 60 cookies Q25) 4
 Q26) 52 cm Q27) a) CD \perp DE b) AB // HG Q28) Q29) \$140 Q30) 2700¢

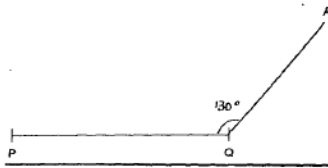

Paper 2

- Q1) $5u \rightarrow 495$
 $1u \rightarrow 495 \div 5 = 99$
 $2u \rightarrow 99 \times 2 \rightarrow \198
- Q2) $\angle DEF = 125^\circ$
- Q3) a) False
 b) False
- Q4) $26 \div 7 = 3 \text{ R } 5 \rightarrow 3 \text{ packets of biscuits}$
- Q5) Chair $\rightarrow \frac{2}{5} \times 420 = 168$
 $168 + 420 = \$588$
- Q6) Total (70) $\rightarrow \frac{4}{7}$ (green) + $\frac{3}{7}$ (red + blue)
 $\frac{3}{7} \times \frac{70}{1} = 30$
 $30 + 16 = 46$
 $46 \div 2 = 23 \text{ red marbles}$

- Q7) Multiple of 6 : 42, 48, 54, 60, 66, 72, 78, 84
 Plus 2 : 44, 50, 56, 62, **68**, 74, 80, 86
 Multiple of 5 : 40, 45, 50, 55, 60, 65, 70, 75, 80, 85
 Plus 3 : 43, 48, 53, 58, 63, **68**, 73, 78, 83, 88

Ans: 68 members

- Q8) Total $\rightarrow \frac{3}{7}$ (sold) + $\frac{4}{7}$ (R)
 $\frac{4}{7}$ (R) $\rightarrow \frac{5}{8}$ (brother) + $\frac{3}{8}$ (left \rightarrow 780)

$$\frac{4}{7} \times \frac{3}{8} = \frac{3}{14}$$

$$3u \rightarrow 780$$

$$1u \rightarrow 780 \div 3 = 260$$

$$14u \rightarrow 260 \times 14 = 3640 \text{ sweets}$$

- Q9) 5 books $\rightarrow 17.50 + 21.75$
 1 book $\rightarrow 39.25 \div 5 = 7.85$
 4 books $\rightarrow 7.85 \times 4 = 31.40$
 Susan $\rightarrow 31.40 + 17.50 = \48.90

- Q10) Area of square = $45 \times 45 = 2025$
 $8 \times 3 = 24$

$$2025 \times 24 = 48\,600 \text{ cm}^2$$

- Q11) a) $185 - 45 = 140$
 $140 \div 2 = 70$
 $70 - 45 = 25$ marbles
 b) $185 + 45 = 230$
 $230 + (25 \times 2) = 230 + 50 = 280$ marbles

- Q12) $540 - 210 = 330$
 $6u \rightarrow 330$

$$1u \rightarrow 330 \div 6 = 55$$

$$210 - 55 \rightarrow 155 \text{ g}$$

- Q13) Extra (red) $\rightarrow 1.3 \times 8 = 10.4$
 $65.9 - 10.4 = 55.5$
 $55.5 \div 3.7 = 15$ (1 set)
 Red $\rightarrow 15 + 8 \rightarrow 23$ pieces

- Q14) $7 \times 142 = 994$
 $7 + 2 = 9$
 $9 \times 144 = 1296$
 $1296 - 994 = 302$
 $302 - 34 = 268$
 $268 \div 2 = 134$
 $100 \text{ cm} = 1 \text{ m}$
 $134 \text{ cm} = 1.34 \text{ m}$

Q15) $480 - 95 = 385$

$11u \rightarrow 385$

$1u \rightarrow 385 \div 11 = 35$

$35 \times 5 = 175$

Diff $\rightarrow 175 + 95 = \$270$

Q16) a) $32 \times 0.20 = 6.40$
 $6.40 + 28.40 = 34.80$

$0.50 - 0.20 = 0.30$

$34.80 \div 0.30 = 116$

$116 + 32 = 148$

b) $116 \times 0.50 = 58$

$58 + 29.60 = 87.60$

$89.20 - 87.60 = \$1.60$

Q17) $4u \rightarrow 34 + 14 = 48$

$1u \rightarrow 48 \div 4 = 12$

$7u \rightarrow 12 \times 7 = 84$

$4p \rightarrow 84 + 6 = 90$

$1p \rightarrow 90 \div 4 = 22.50$

$5p \rightarrow 22.50 \times 5 = \112.50

End