

**NANYANG PRIMARY SCHOOL
PRELIMINARY EXAMINATION
2016**

**PRIMARY 6
MATHEMATICS
PAPER 1**

DURATION: 50 MINUTES

Booklet A	/ 20	Paper 1 Total: / 40
Booklet B	/ 20	

Name: _____ ()

Class: Primary 6 ()

Date: _____

Any query on marks awarded should be raised by 6 September. We seek your understanding in this matter as any delay in the confirmation of marks will lead to delays in the generation of results.

Parent's Signature: _____

**DO NOT OPEN THIS BOOKLET UNTIL YOU ARE TOLD TO DO SO.
FOLLOW ALL INSTRUCTIONS CAREFULLY.
ANSWER ALL QUESTIONS.**

YOU ARE NOT ALLOWED TO USE A CALCULATOR.

PAPER 1 (BOOKLET A)

Questions 1 to 10 carry 1 mark each. Questions 11 to 15 carry 2 marks each. For each question, four options are given. One of them is the correct answer. Make your choice (1, 2, 3 or 4). Shade the oval (1, 2, 3 or 4) on the Optical Answer Sheet.

(20 marks)

1 Which one of the following numbers has the digit 5 in the ten thousands place?

- (1) 435 224
- (2) 321 051
- (3) 223 543
- (4) 152 234

2 In the number line below, which point, A, B, C or D, represents the number 245?

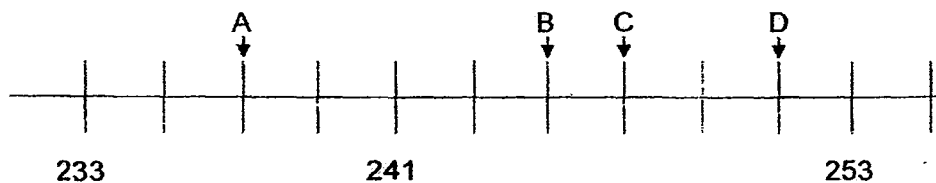

- (1) A
- (2) B
- (3) C
- (4) D

3 What is the lowest common multiple of 4 and 8?

- (1) 1
- (2) 32
- (3) 8
- (4) 4

4 Express 2 tens and 32 thousandths as a decimal.

- (1) 2.032
- (2) 2.32
- (3) 20.032
- (4) 20.32

5 The cost of 4 similar books is \$12.80. What is the cost of 2 such books?

- (1) \$3.20
- (2) \$6.40
- (3) \$19.20
- (4) \$25.60

6 What is the difference in volume between a 2-cm cube and a 3-cm cube?

- (1) 8 cm^3
- (2) 19 cm^3
- (3) 27 cm^3
- (4) 35 cm^3

7 In the figure below, ABC is a straight line. $\angle ABD$ is twice the size of $\angle DBE$ and $\angle EBC = 120^\circ$. Find $\angle DBE$.

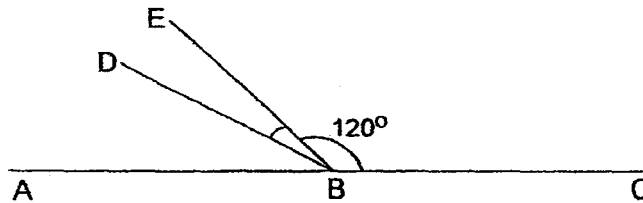



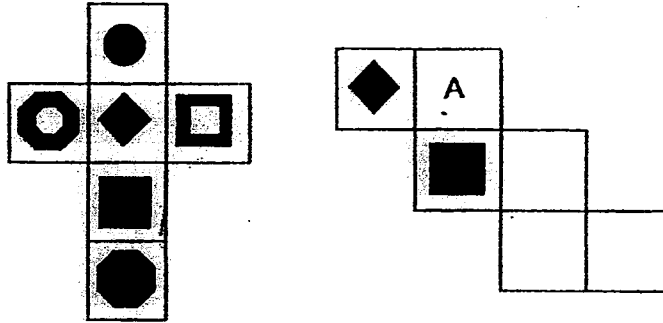

- (1) 20°
- (2) 40°
- (3) 60°
- (4) 80°

- 8 The figures below show 2 nets of the same cube.



Which one of the shapes given below is represented by the letter A in the net?

- (1) 
 - (2) 
 - (3) 
 - (4) 
- 9 Liyan is 10 kg heavier than Kenny. Their total mass is 60 kg. Find the ratio of Kenny's mass to Liyan's mass.

- (1) 5 : 7
- (2) 5 : 12
- (3) 7 : 5
- (4) 12 : 7

10 Min Ho deposited \$20 000 into a bank at the beginning of the year. The annual interest for depositing money into the bank was 5%. How much did Min Ho have in the bank at the end of the year if he did not take out any money from the bank?

- (1) \$1000
- (2) \$19 000
- (3) \$21 000
- (4) \$31 000

11 Yu Na took 2 hours and 30 minutes to finish her homework. She took 1 hour to finish her Science homework, $\frac{1}{3}$ of the remaining time on English homework and the rest of the time on Math homework. How much time did she take to finish her Math homework?

- (1) 150 minutes
- (2) 120 minutes
- (3) 90 minutes
- (4) 60 minutes

12 A container measuring 50 cm by 60 cm by 20 cm is half-filled with water. What is the volume of the water in the container?

- (1) 7500 cm³
- (2) 15 000 cm³
- (3) 30 000 cm³
- (4) 60 000 cm³

13 A group of 8 students stood around a circle, dividing its circumference into 8 equal parts. Kerry stood facing Daisy at first. Then, Kerry made a 90° anticlockwise turn, followed by a 135° clockwise turn. Who did Kerry face in the end?

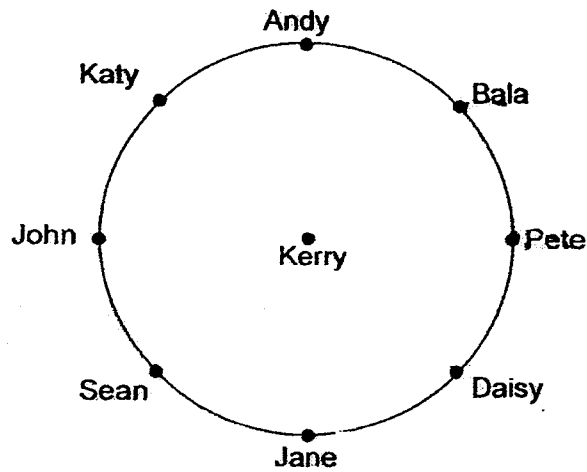

- (1) Pete
- (2) Jane
- (3) John
- (4) Andy

- 14 The pie chart below shows the different types of fruits sold at a fruit store. 40% of them are peaches and figs. What percentage of the fruits are melons?

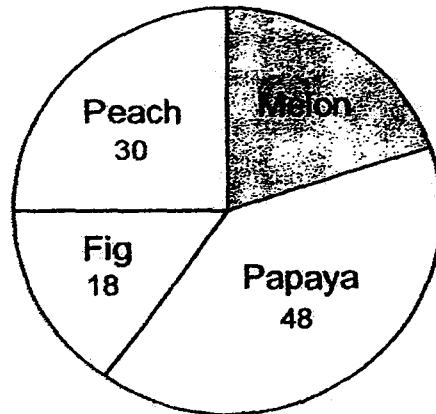

- (1) 20%
- (2) 24%
- (3) 40%
- (4) 80%
- 15 Shirley had $(18y + 10)$ metres of cloth. She made 2 identical dresses using $5y$ metres each. How much cloth did Shirley have left?
- (1) $8y$ metres
- (2) $(8y + 10)$ metres
- (3) $13y$ metres
- (4) $(13y + 10)$ metres

18 Find the value of $7 \times \frac{5}{4}$.

Ans: _____

19 Soong Ki's height is 1.85 m. Round off his height to the nearest tenth.

Ans: _____ m

20 Siti went to bed at 22 00 and woke up the next day at 06 10. How long did Siti sleep? Give your answer in hours and minutes.

Ans: _____ h _____ min

- 21 The rectangle below is made up of 6 identical squares with an area of 81 cm^2 each. What is the length of the rectangle?

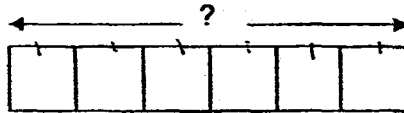

Ans: _____ cm

- 22 In the figure below, ABCD is a parallelogram and DCE is a straight line. $\angle ADC = 58^\circ$ and $\angle CEB = 56^\circ$. Find $\angle CBE$.

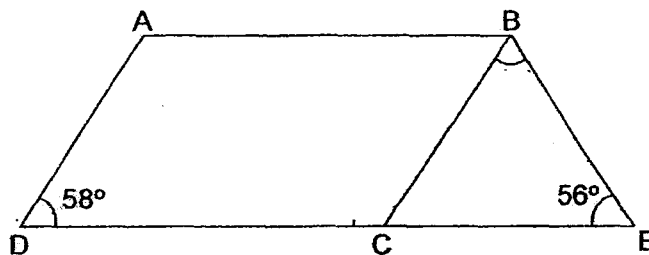

Ans: _____ °

- 23 In the grid below, draw 2 lines of symmetry for the letter H.

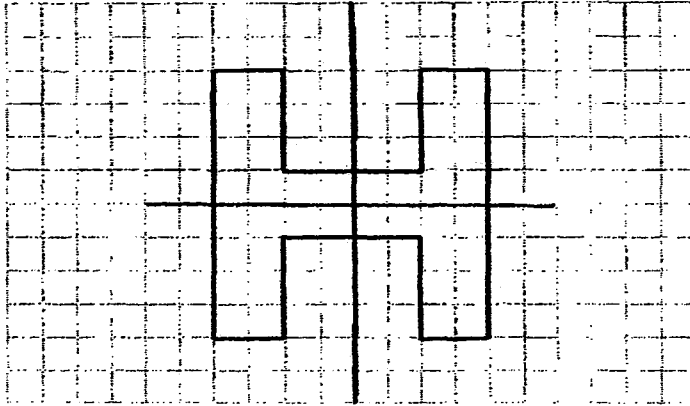

- 24 Darren has 100 stamps. The ratio of Darren's number of stamps to Kelly's number of stamps is 4 : 5. Find the difference between Kelly's number of stamps and Darren's number of stamps.

Ans: _____

- 25 The mass of a bag of rice is $1\frac{1}{2}$ kg. The mass of another bag of rice is $\frac{1}{4}$ kg less. What is the total mass of the 2 bags of rice?

Ans: _____ kg

Questions 26 to 30 carry 2 marks each. Show your working clearly in the space provided for each question and write your answers in the spaces provided. For questions which require units, give your answers in the units stated.

(10 marks)

- 26 The total length of 3 metal rods is $\frac{11}{12}$ m. What is the average length of the 3 metal rods?

Ans: _____ m

- 27 The perimeter of a rectangle is 56 cm. The breadth is $\frac{1}{3}$ of its length. What is the length of the rectangle?

Ans: _____ cm

- 28 The pattern in the box below shows part of a tessellation. Extend the tessellation by drawing two more unit shapes in the space provided within the box.

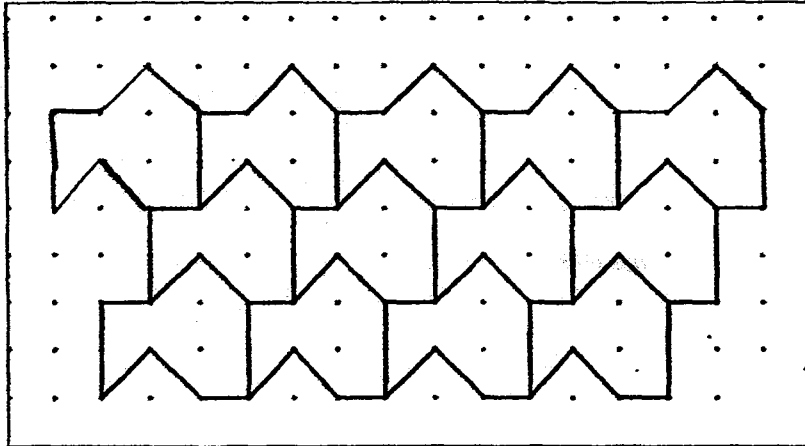

- 29 Jack is 5 years older than his sister Jill. Their combined age was $36m$ years old m years ago. How old is Jack now?

Ans: _____

- 30 Four classes, 6A, 6B, 6C and 6D, folded paper planes to decorate the school. The table below shows the number of paper planes each class had folded. The information for class 6D was missing.

Class	Number of paper planes folded
6A	20
6B	30
6C	40
6D	?

Class 6D folded 3 more paper planes than the average number of paper planes that the 4 classes folded. The number of paper planes folded are in whole numbers. How many paper planes did the 4 classes fold altogether?

Ans: _____

++++END OF PAPER++++





NANYANG PRIMARY SCHOOL
PRELIMINARY EXAMINATION
2016

PRIMARY 6
MATHEMATICS
PAPER 2

DURATION: 1 HOUR 40 MINUTES

Paper 2 Total	/ 60
GRAND TOTAL	/ 100

Name: _____ ()

Class: Primary 6

Date: _____

Any query on marks awarded should be raised by 6 September. We seek your understanding in this matter as any delay in the confirmation of marks will lead to delays in the generation of results.

Parent's Signature: _____

DO NOT OPEN THIS BOOKLET UNTIL YOU ARE TOLD TO DO SO.
FOLLOW ALL INSTRUCTIONS CAREFULLY.
ANSWER ALL QUESTIONS.

YOU ARE ALLOWED TO USE A CALCULATOR.

PAPER 2

Questions 1 to 5 carry 2 marks each. Show your working clearly in the space provided for each question and write your answers in the spaces provided. For questions which require units, give your answers in the units stated.

(10 marks)

- 1 Fill in the boxes with +, -, × and/or ÷ to make the number statement true. Use each operation only once.

$$45 \square 3 \square (5 \square 2) = 24$$

- 2 Find the perimeter of the figure below.

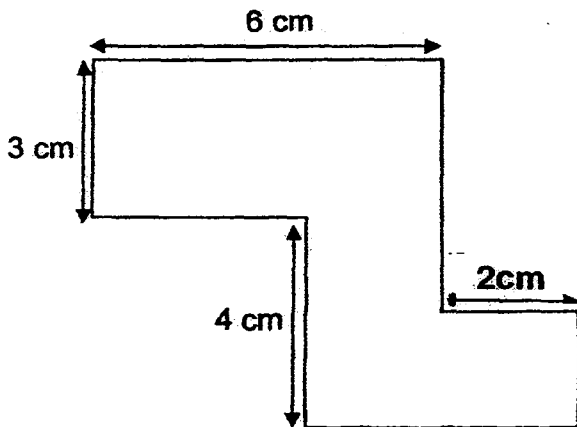

Ans: _____ cm

- 3 In the year 2014, the cost of a television was \$750. In the year 2015, the cost of the same television was \$600. What was the percentage decrease in the price of the television from 2014 to 2015?

Ans: _____ %

- 4 The figure below shows a box that can be completely filled with two hundred 2-cm cubes. What is the breadth of the cuboid?

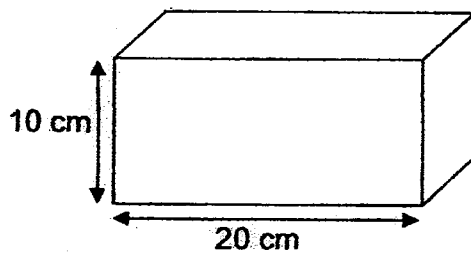

Ans: _____ cm

- 5 Timothy wrote the numbers 3, 7, 19, 29 and 43 on a board. He then erased one of the numbers and calculated the average of the remaining numbers. The average of the remaining numbers was a whole number. Which one of the above numbers did Timothy erase?

Ans: _____

For questions 6 to 18, show your working clearly in the space provided for each question and write your answers in the spaces provided.

The number of marks available is shown in brackets [] at the end of each question or part-question.

(50 marks)

-
- 6 In a camp, there were 280 more boys than girls. 30% of the participants were girls. How many boys were there in the camp?

Ans: _____ [3]

-
- 7 Study the pattern below and answer the following questions.

Pattern \diamond \circ Σ Δ \odot \diamond \circ Σ Δ \odot \diamond \circ Σ Δ \odot \diamond \circ ...
Position 10 18

- (a) What is the symbol in Position 1? Draw the symbol.
- (b) What is the symbol in Position 153? Draw the symbol.

Ans: (a) _____ [1]

(b) _____ [2]

- 8 Mrs Tan bought some pink, yellow, red, blue and green balloons for a party. The chart below shows the number of balloons of each colour.

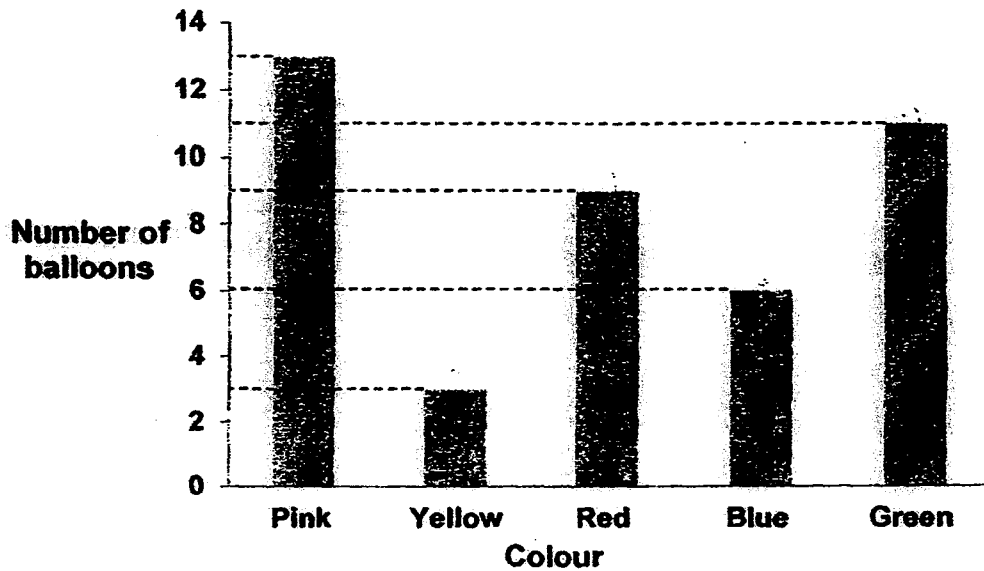

- (a) How many balloons did Mrs Tan buy altogether?
- (b) Each blue balloon cost \$0.10 more than each yellow balloon. Mrs Tan spent a total amount of \$10.50 on blue balloons and yellow balloons. Find the cost of each blue balloon.

Ans: (a) _____ [2]

(b) _____ [2]

- 9 The figure below is made up of 2 squares of different lengths and 1 rectangle. Find the area of the shaded part.

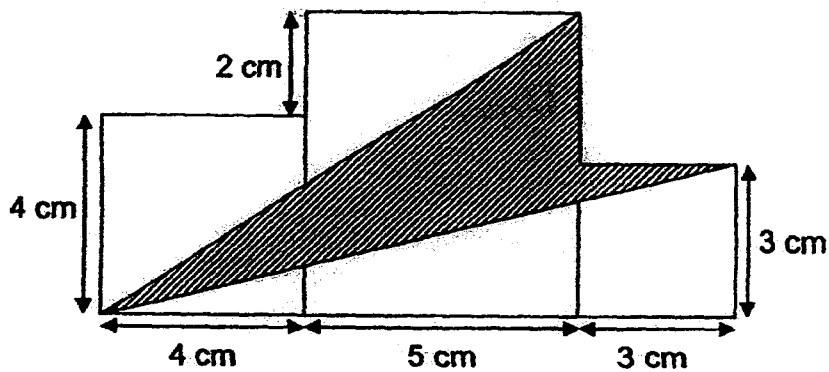

Ans: _____ [4]

- 10 The figure below is made up of a right-angled isosceles triangle ABC, a square and a circle. The area of triangle ABC is 18 cm^2 . The diameter of the circle is the same as the side of the square. Find the area of the circle. Leave your answer in terms of π .

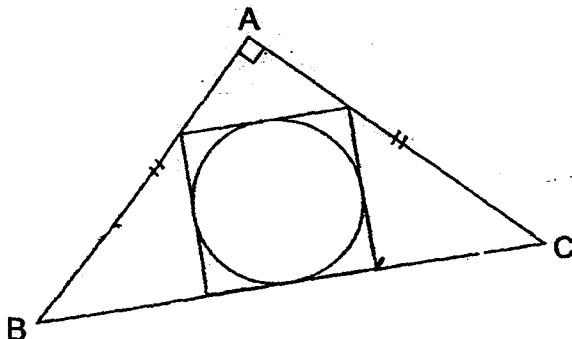

Ans: _____ [3]

- 11 John had a container measuring 35 cm by 20 cm by 25 cm. He placed a solid made of 4 identical 5-cm cubes in the tank and then filled the tank completely with water as shown in the figure below. He then poured out 11387.5 ml of water. What was the height of the water in the tank in the end?

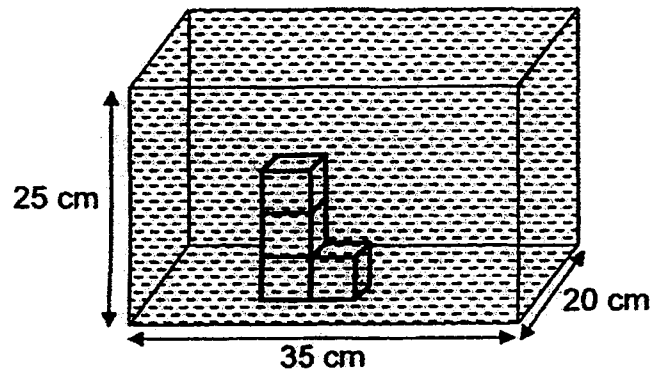

Ans: _____ [4]

- 12 In the figure below, ABCD is a rhombus. DEB is a straight line and $DA = DE$. $\angle AED$ is 39° more than $\angle ADE$. Find $\angle DCB$.

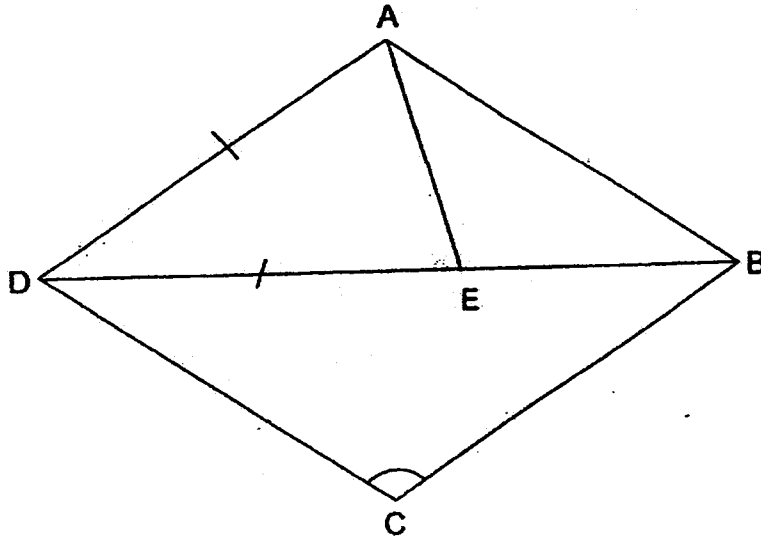

Ans: _____ [4]

- 13 Si Jin had $\frac{6}{5}$ as many beads as Aminah. Si Jin gave $\frac{3}{10}$ of his beads to Aminah. Aminah then gave $\frac{1}{2}$ of her beads to Si Jin. In the end, Si Jin had 252 more beads than Aminah. How many beads did Si Jin have at first?

Ans: _____ [5]

14 Study the following number pattern.

11 , 13 , 15 , 17 , 19 , 31 , 33 , 35 , 97 , 99

The pattern above consists of only 2-digit whole numbers. Both the digits in the ones and tens place in these 2-digit numbers are odd numbers.

- (a) How many numbers are there altogether?**
- (b) Find the sum of all the numbers in the pattern.**

Ans: (a) _____ [2]

(b) _____ [2]

- 15 At 8 a.m., Mingwei started travelling from Town A to Town B. At 8.40 a.m., Ali started travelling from Town B to Town A. Mingwei's speed and Ali's speed were 45 km/h and 30 km/h respectively. They did not change their speeds throughout the journey. When they met each other, their distance from Town A was twice their distance from Town B. Find the distance between Town A and Town B.

Ans: _____ [3]

- 16 Valerie, Jake and Zechariah shared the cost of a present. $\frac{3}{5}$ of Zechariah's share was equal to $\frac{1}{3}$ the total of Jake's and Valerie's share. $\frac{2}{3}$ of Jake's share was equal to $\frac{1}{3}$ the total of Zechariah's and Valerie's share. Valerie paid \$30 less than Zechariah. How much did the present cost?

Ans: _____ [5]

- 17 Rectangle ABCD and rectangle MNPQ have the same perimeter. The breadth of rectangle ABCD is twice the breadth of rectangle MNPQ. The ratio of the length of rectangle ABCD to that of rectangle MNPQ is 11 : 13. The breadth of rectangle ABCD is 28 cm shorter than its length. Find the area of rectangle MNPQ.

Ans: _____ [5]

- 18 Abbey and Ben had some money each. The amount of money that Abbey had was a whole number. Abbey wanted to buy a watch using all her money but she was short of \$90.50. Ben wanted to buy the same watch using all his money but he was short of \$1.80. The total amount of money that both of them had was still not enough to buy the watch. How much was the watch?

Ans: _____ [3]

++++END OF PAPER++++

YEAR : 2016
LEVEL : PRIMARY 6
SCHOOL : NANYANG PRIMARY
SUBJECT : MATHEMATICS
TERM : PRELIMINARY EXAMINATION

Paper 1

Q1	4	Q4	3	Q7	1	Q10	3	Q13	2
Q2	2	Q5	2	Q8	3	Q11	4	Q14	1
Q3	3	Q6	2	Q9	1	Q12	3	Q15	2

Q16

2
9

Q17 $36 \div 2 = \underline{18 \text{ km/h}}$

Q18 $7 \times \frac{5}{4} = \frac{35}{4} = \underline{8\frac{3}{4}}$

Q19 1.9 m

Q20 8 h 10 min

Q21 $\sqrt{81} = 9 \Rightarrow 9 \times 6 = \underline{54}$

Q22 $180^\circ - 58^\circ = 122^\circ \Rightarrow 122^\circ - 56^\circ = 66^\circ$

Q23

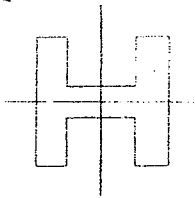

Q24 D : K

4 : 5

Diff $\rightarrow 100 \div 4 = \underline{25 \text{ stamps}}$

Q25 61 $\rightarrow 1\frac{1}{2} \text{ kg} = 1\frac{2}{4} \text{ kg}$

62 $\rightarrow 1\frac{2}{4} - \frac{1}{4} \text{ kg} = 1\frac{1}{4} \text{ kg}$

Total $\Rightarrow 1\frac{1}{4} \text{ kg} + 1\frac{2}{4} \text{ kg} = 2\frac{3}{4} \text{ kg}$

Q26 $\frac{11}{12} \div 3 = \frac{11}{36} \text{ m}$

Q27 $B \rightarrow 1, L \rightarrow 3$
 $1 + 3 + 1 + 3 = 8$
 $1u \rightarrow 56 \div 8 = 7$
 $3u \rightarrow 7 \times 3 = \underline{21 \text{ cm}}$

Q28

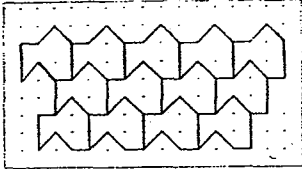

Q29 $36m + m + m = 38m \Rightarrow \frac{38m+5}{2}$ years old

Q30 $90 + 3 = 93$
 $93 \div 3 = 31$
 $31 \times 4 = \underline{124}$ paper planes

Paper 2

Q1 $45 - 3 \times (5 + 2) = 24$

Q2 $4 + 4 + 2 + 3 + 3 + 2 + 6 + 6 = \underline{30 \text{ cm}}$

Q3 Decrease $\rightarrow 750 - 600 = 150$
 $\% \text{ Decrease} \rightarrow \frac{150}{750} \times 100 = \underline{20 \%}$

Q4 $4 \times 2 = \underline{8 \text{ cm}}$

Q5 29

Q6 $B \rightarrow \frac{7}{10}$
 More $\frac{7}{10} - \frac{3}{10} = \frac{4}{10}$
 $4u \rightarrow 280$
 $7u \rightarrow \frac{280}{4} \times 7 = \underline{490}$ boys

Q7a O

Q7b Δ

Q8a $13 + 3 + 9 + 6 + 11 = \underline{42}$ balloons

Q8b $6 \times 0.10 = 0.60$
 $9u \rightarrow 10.50 - 0.60 = 9.90$
 $1u \rightarrow 9.90 \div 9 = 1.10$
 Blue $\Rightarrow 1.10 + 0.10 = \underline{\$1.20}$



Q9 1 full area $\rightarrow (4 + 2) \times (4 + 5 + 3) = 72$

A $\rightarrow \frac{1}{2} \times 3 \times (4 + 5 + 3) = 18$

B $\rightarrow 3 \times 3 = 9$

C $\rightarrow \frac{1}{2} \times 6 \times (4 + 5) = 27$

Shaded $\Rightarrow 72 - 27 - 9 - 18 = \underline{18 \text{ cm}^2}$

Q10 9 small \triangle

1 small $\triangle \rightarrow 18 \div 9 = 2$

1 square $\rightarrow 2 \times 4 = 8 \Rightarrow 8 \div 4 = \underline{2\pi}$

Q11 8.5 cm

Q12 $\angle AED \rightarrow \angle ADE + 39^\circ$

$\angle ADE \rightarrow (180^\circ - 39^\circ - 39^\circ) \div 3 = 34^\circ$

$\angle DCB \rightarrow 180^\circ - 34^\circ - 34^\circ = \underline{112^\circ}$

Q13 SJ $\rightarrow 6 \times 10 = 60$

A $\rightarrow 5 \times 10 = 50$

Gave SJ - A $\rightarrow \frac{60}{10} \times 3 = 18$, now SJ $\rightarrow 42$ & A $\rightarrow 68$

A gave SJ $\rightarrow 68 \div 2 = 34$, now SJ $\rightarrow 76$ & A $\rightarrow 34$

252 $\rightarrow 42u$

1u $\rightarrow 252 \div 42 = 6$

60u $\Rightarrow 6 \times 60 = \underline{360}$ beads

Q14a 25 numbers

Q14b $11 + 99 = 110$

$25 \div 2 = 12.5$

$12.5 \times 110 = \underline{1375}$

Q15 $30 + 45u = 2 \times 30u$

$30 + 45u = 60u$

$15u \rightarrow 30$, 1u $\rightarrow 30 \div 15 = 2$

$30 \times 2 = 60 \Rightarrow 60 \times 3 = \underline{180 \text{ km}}$

Q16 V $\rightarrow 84 - 45 = 39$

30 $\rightarrow 45 - 39 = 6$

1u $\rightarrow 30 \div 6 = 5$

126u $\Rightarrow 126 \times 5 = \underline{\$630}$

Q17 1u $\rightarrow 28 \div 7 = 4$

$2 \times 4 = 8$

$13 \times 4 = 52$

$52 \times 8 = \underline{416 \text{ cm}}$

Q18 $1 + \$90.50 = \underline{\$91.50}$

End

