

SINGAPORE CHINESE GIRLS' SCHOOL
SECOND SEMESTRAL ASSESSMENT 2015

SCIENCE

PRIMARY FIVE

NAME: _____ ()

DATE: _____

CLASS: PRIMARY 5

BOOKLET A

30 questions

60 marks

Total time for Booklets A & B: 1 h 45 min

DO NOT OPEN THIS BOOKLET UNTIL YOU ARE TOLD TO DO SO.

FOLLOW ALL INSTRUCTIONS CAREFULLY.



Part I (60 marks)

For each question from 1 to 30, four options are given. One of them is the correct answer. Make your choice (1, 2, 3 or 4). **Shade the correct oval (1, 2, 3 or 4) on the Optical Answer Sheet.**

1. Joseph placed a table lamp next to a tank of earthworms and turned the lamp on. After 30 minutes, he observed that most of the earthworms had moved to the area under the lid.

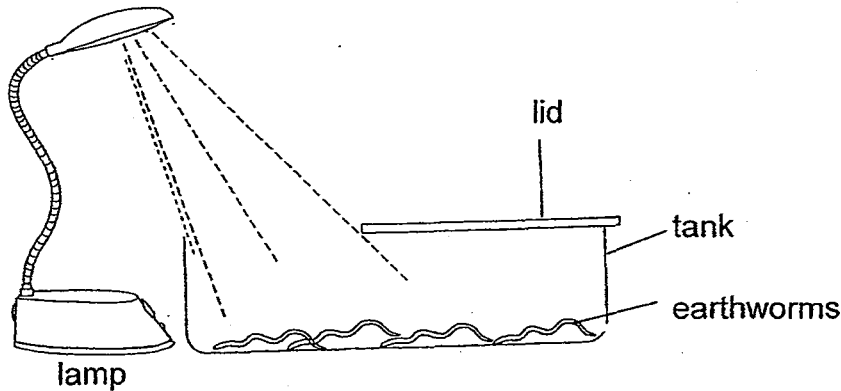

What does this experiment show?



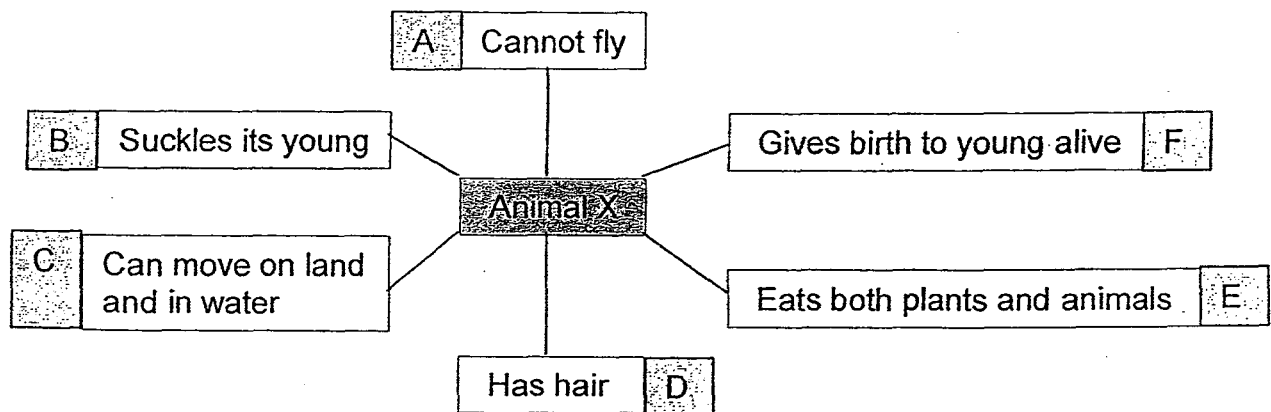



- 1) Animals can reproduce.
 - 2) Animals respond to changes.
 - 3) Animals need light to survive.
 - 4) Animals need warmth to survive.
2. Study the concept map below.

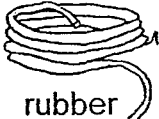

Which of the following are characteristics of mammals?

- 1) A, C, E only
- 2) C, E, F only
- 3) B, D and F only
- 4) B, C, D and E only

3.

Group A		Group B	
 iron nails	 Wooden mallet	 cotton socks	 rubber hose
 ceramic cup	 steel pot	 rubber slippers	 plastic mat

How are the items above grouped?

	Group A	Group B
1)	Waterproof	Non-water proof
2)	Non-flexible	Flexible
3)	Magnetic	Non-magnetic
4)	Made of man-made materials	Made of materials that were once alive

4.

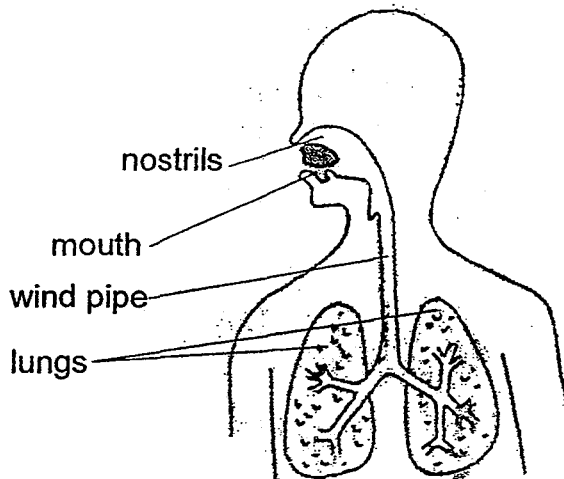

Choking happens when the path of air is blocked. At which point does choking occur in our respiratory system?

- 1) nostrils
- 2) mouth
- 3) windpipe
- 4) lungs

5. The diagram below shows the human digestive system.

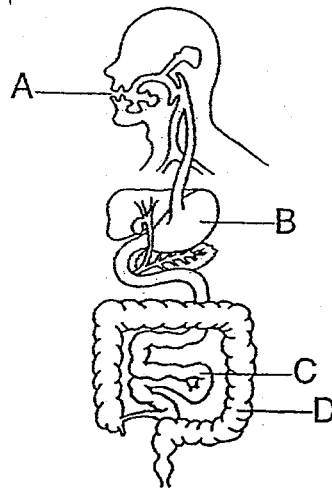

Sally and Alice both made a record of the amount of undigested food before it leaves each part of the digestive system in a table as shown below.

	Sally	Alice
	Amount of undigested food (g)	Amount of undigested food (g)
Start Of experiment	35	35
Part A	30	35
Part B	18	16
Part C	8	16
Part D	8	10

Which of the following statements is true about the recording?

- 1) Sally made an accurate recording.
- 2) Alice made an accurate recording.
- 3) Alice made 1 error in her recording.
- 4) Sally made 2 errors in her recording.

6. The diagrams below show 2 different cells.

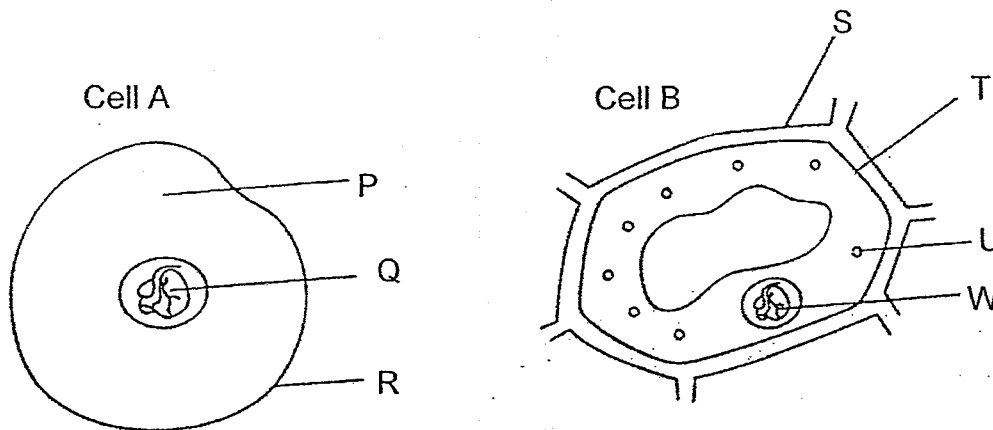

Which parts in both cells, A and B, are responsible for controlling the movement of substances in and out of cells?

- 1) P and U
- 2) Q and W
- 3) R and S
- 4) R and T

7. Mdm Tan sealed the room by closing all the windows and the door of the room. She did not turn on the fan and air-conditioner. After 15 minutes, what would happen to the amount of oxygen, carbon dioxide and water vapour in the air if she remained inside?

	Oxygen	Carbon Dioxide	Water Vapour
1)	Increase	Decrease	Remain the same
2)	Decrease	Increase	Decrease
3)	Remain the same	Decrease	Increase
4)	Decrease	Increase	Increase

8. The picture below is a diagram of the human circulatory system. The arrows P, Q, R and S represent the direction of blood flow in the blood vessels.

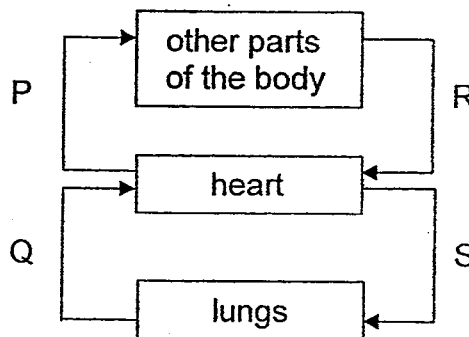

Which blood vessels carry blood rich in carbon dioxide?

- 1) P and Q only
- 2) P and S only
- 3) Q and R only
- 4) R and S only

9. The following table shows the comparison between a plant transport system and a human circulatory system.

Which of these comparison statement/s is/are correct?

	Plant transport system	Human circulatory system
A:	There is no pump in the plant transport system.	The heart serves as a pump in the human transport system.
B:	It transports many substances.	It transports only one substance.
C:	There are food and water carrying tubes to transport the various substances to the other parts of the plant.	There are blood vessels to transport various substances to the other parts of the body.

- 1) A only
2) B only
3) A and C only
4) B and C only
10. The diagram below shows a tree. Which of the following statements about the parts of the tree is correct?

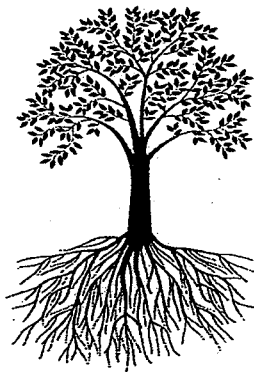

- 1) The roots help the tree to remain upright.
2) The leaves take in sunlight through their stomata.
3) The roots spread out to hold the tree firmly to the ground.
4) The branches spread out to ensure more water is taken in.

11. May Lin set up a circuit as shown below.

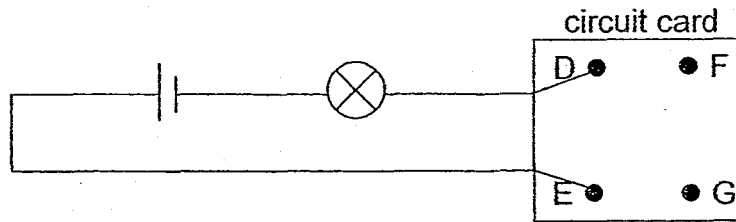

How should the wires be connected inside the circuit card to light up the bulb?

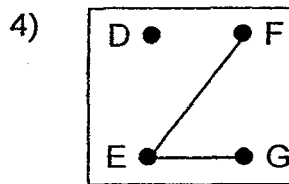
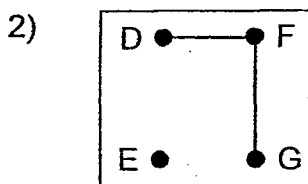
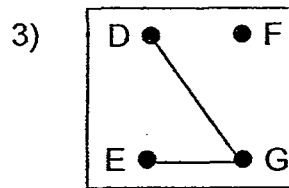
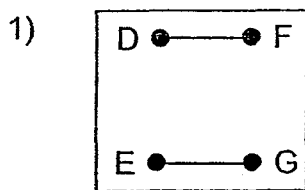

12. Louie set up an experiment as shown in the diagram below. The bulb lit up when he connected the 2 metal clips to a container made of Material A.

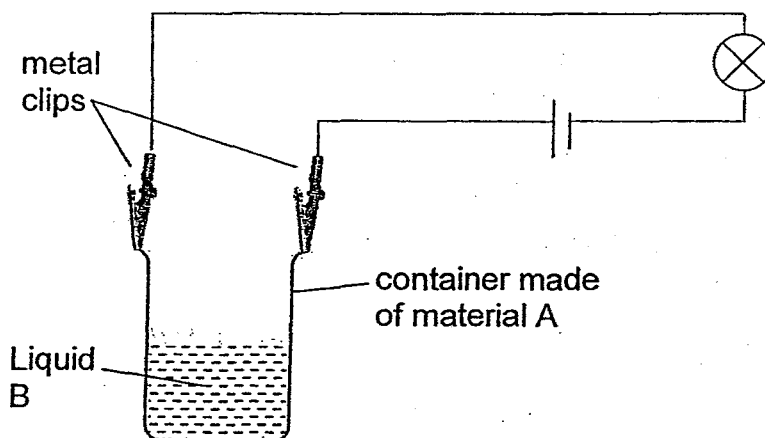

Based on the experiment above, which one of the statements is definitely true?

- 1) Liquid B is a conductor of electricity.
- 2) Material A is a conductor of electricity.
- 3) Material A and Liquid B are both conductors of electricity.
- 4) Material A will conduct electricity only when Liquid B is inside the container.

13. The diagram below shows 2 bulbs connected in a circuit and 3 switches controlling the flow of electricity within the circuit.

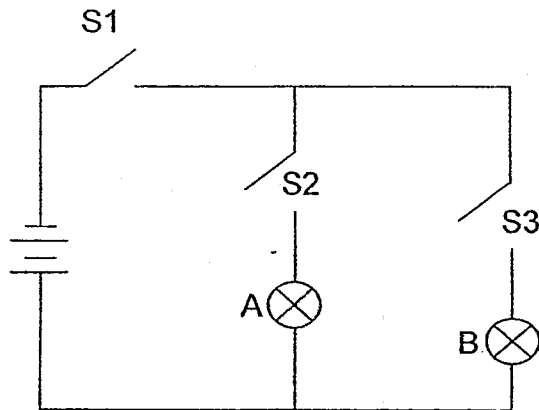

In order for only Bulb A to light up, which switches should be closed?

- | | |
|-------------------|-------------------|
| 1) S1 and S2 only | 3) S1 and S3 only |
| 2) S2 and S3 only | 4) S1, S2 and S3 |

14. Study the 4 circuit diagrams as shown below.

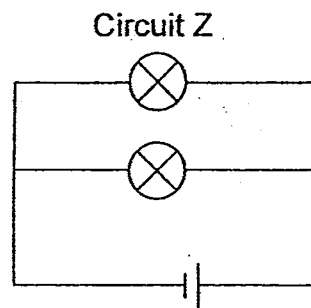
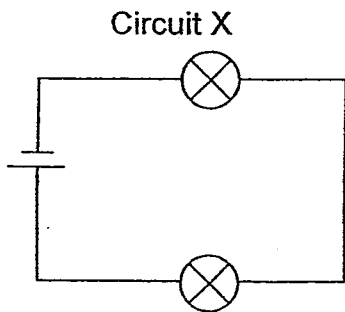
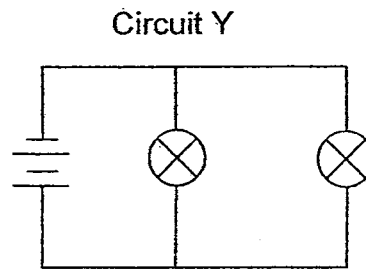
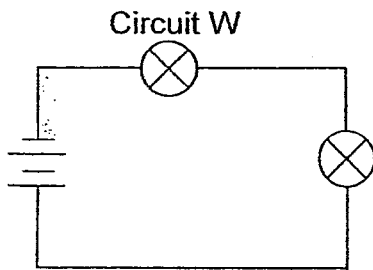

Which circuit has the brightest bulbs?

- | | |
|------|------|
| 1) W | 3) Y |
| 2) X | 4) Z |

15. Lisa used 4 similar ring magnets P, Q, R and S and made 3 setups as shown in the diagram below.

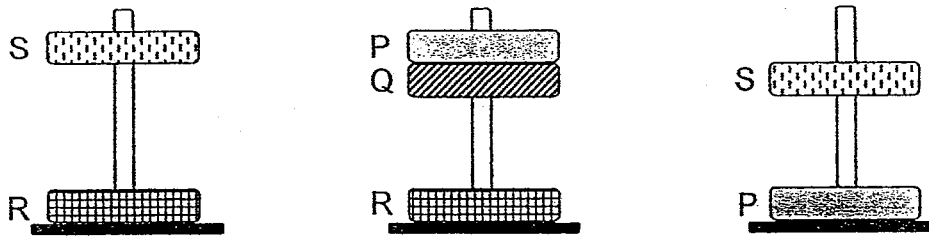

Based on her observations, what conclusions can she make?

- A: All the like poles of the magnets are facing each other.
- B: Magnet P has a stronger magnetic force than Magnet Q.
- C: Magnet R has a stronger magnetic force than Magnet P.
- D: The magnets 'floating' above each other are caused by repulsion of the magnets.

- (1) A and C only
- (2) C and D only
- (3) A, C and D only
- (4) B, C and D only

16. Leo dropped a bar magnet into a box of paper clips accidentally. When he picked it up, at which point/s would he find the most number of paperclips attached to the bar magnet?

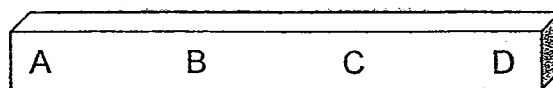

- 1) A only
- 2) A and B only
- 3) C and D only
- 4) A and D only

17. Study Simon's family tree below.

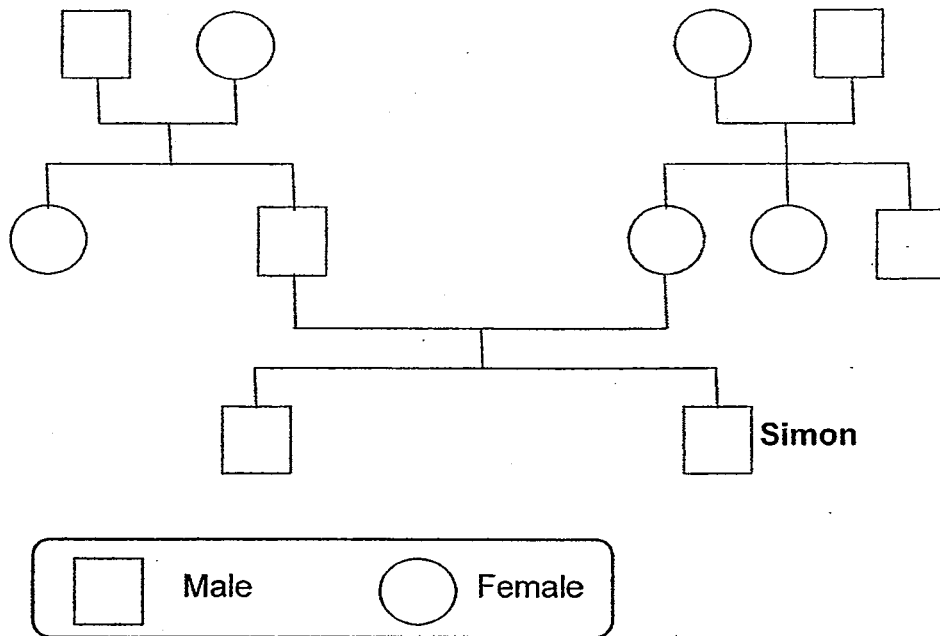

How many uncles and aunts does Simon have?

- 1) 1 aunt, 2 uncles
- 2) 2 aunts, 1 uncle
- 3) 2 aunts, 2 uncles
- 4) 3 aunts, 2 uncles

18. Ken made some observations of 3 animals, A, B and C. He drew up a table of his observations as follows:

Observation	Animal A	Animal B	Animal C
Young moults	✓		✓
Young resembles the adult	✓		
Three-stage life cycle	✓	✓	
Eggs are laid in water		✓	✓

Which of the following correctly represents Animals A, B and C?

	Animal A	Animal B	Animal C
1)	Cockroach	Frog	Mosquito
2)	Mosquito	Frog	Grasshopper
3)	Grasshopper	Cockroach	Frog
4)	Frog	Cockroach	Mosquito

19. Wei En wanted to find out if Seed X or Seed Y germinates faster under the same conditions.

She listed some variables for the experiment as follows:

- A: Type of seeds
- B: Number of seeds
- C: Amount of water
- D: Temperature of surrounding

Which of the variables must be kept constant for the experiment?

- 1) A and B only
- 2) B and C only
- 3) A, C and D only
- 4) B, C and D only

20. Jo conducted an experiment on 4 flowers from a plant in her garden. The flowers have both male and female parts in the same flower.





The table below shows which part Jo removed from each flower.

Parts removed	Flower D	Flower E	Flower F	Flower G
Ovary		✓		
Anthers	✓		✓	
Petals	✓			✓

From the information provided in the table, which of the flowers would still be able to produce fruits?

- 1) E only
- 2) D and F only
- 3) E and G only
- 4) D, F and G only

21. Lauren found 4 different types of fruits in her garden.

			
Fruit A ✗	Fruit B ✓	Fruit C ✓	Fruit D ✓
Inedible, has wing-like structure	Edible, fleshy with a big hard seed that cannot be swallowed	Edible, fleshy with small hard seeds	Inedible, has hooks and spikes

Which of the fruit/s above is/are dispersed by animals?

- 1) A only
- 2) A and D only
- 3) B and C only
- 4) B, C and D only

22. The diagram below shows the female reproductive system.

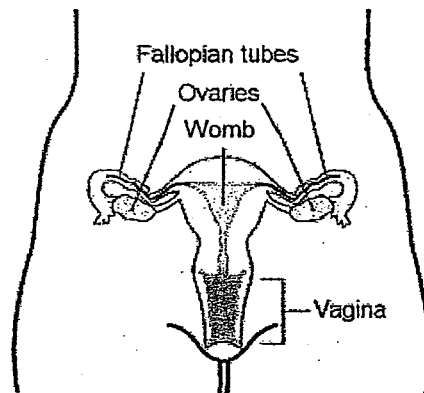

Which part of the reproductive system are egg cells stored?

- 1) womb
- 2) vagina
- 3) ovaries
- 4) fallopian tubes

23. Study the flow chart below.

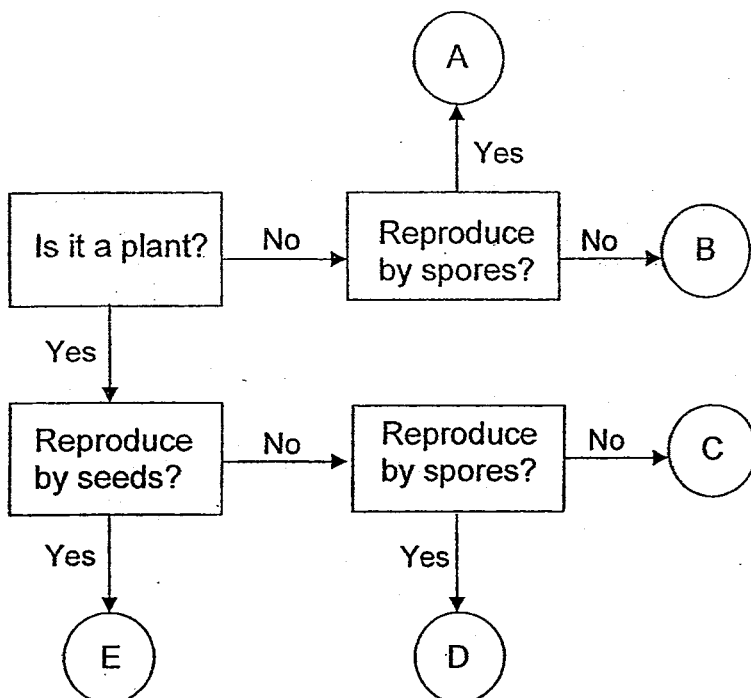

Which letters represent the fern and sunflower respectively?

	Fern	Sunflower
1)	E	A
2)	D	E
3)	B	C
4)	C	D

24. Melanie conducted an experiment on 3 substances X, Y and Z and recorded her observations as follow:

- X, Y and Z take up space.
- X has a definite volume.
- Y can be compressed.
- Z does not have a definite shape.

Which of these are possible conclusions from her experiment?

	Solid	Liquid	Gas
1)	X, Z	X	Y
2)	X	Z	X, Y
3)	X	X, Z	Y
4)	Y	Y, Z	X

25. The diagram below shows the changes in state of water.

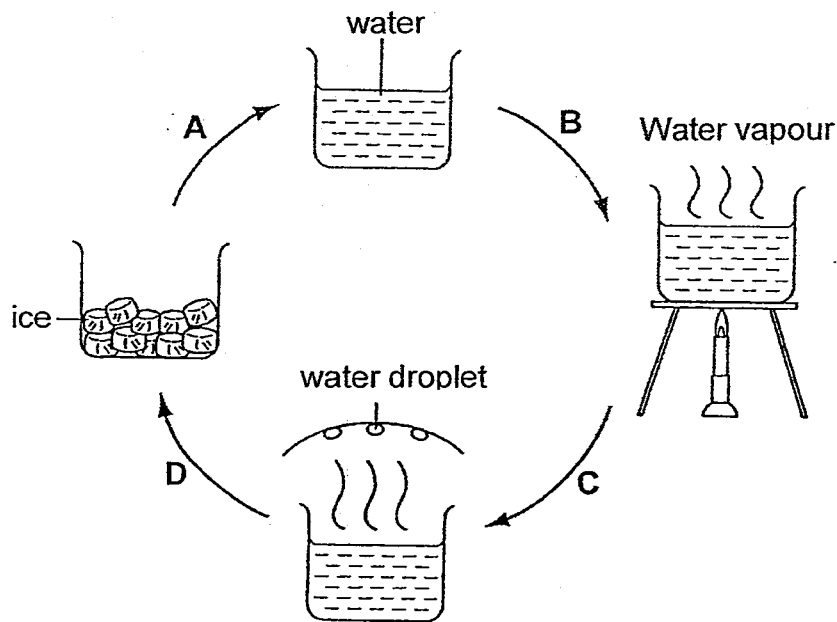

What do processes A, B, C and D represent in the above diagram?

	A	B	C	D
1)	melting	evaporation	condensation	freezing
2)	freezing	condensation	melting	evaporation
3)	condensation	melting	freezing	evaporation
4)	evaporation	freezing	melting	condensation

26. Joseph soaked 4 similar towels, A, B, C and D, in water and weighed them to ensure they absorbed equal amounts of water. He then hung all 4 towels to dry under bright sunlight.

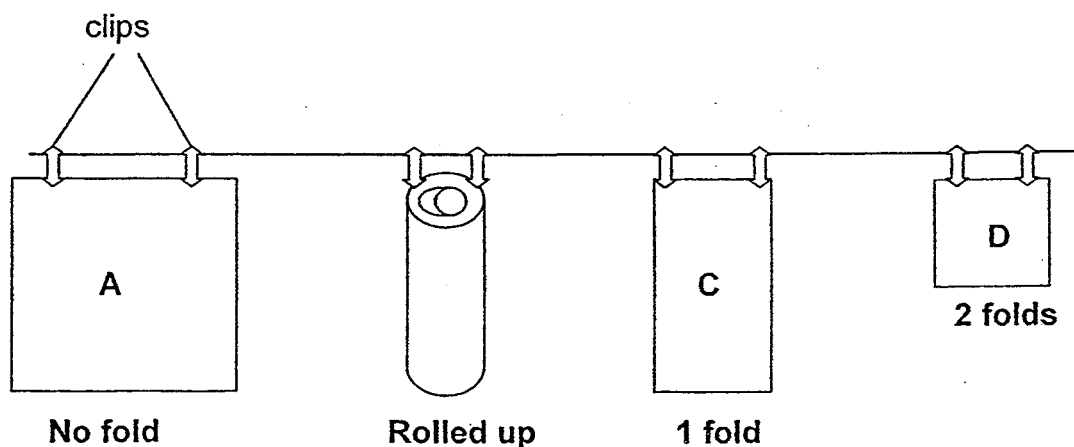

Which towel will be driest after 5 hours?

- 1) A
- 2) B
- 3) C
- 4) D

27. Raymond used some wax to attach 4 similar metal pins to 2 metal rods of the same length. Both rods are made of different metals and Rod P is a better conductor of heat than Rod Q.

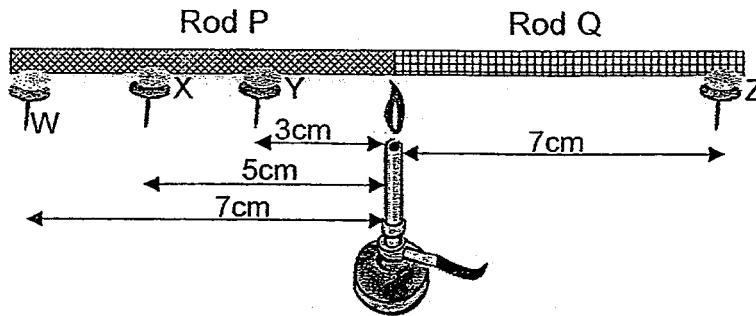

Arrange in sequence, the order in which the metal pins drop off from the rods, starting from the pin that drops off first.

- 1) W, X, Y, Z
 - 2) X, Y, Z, W
 - 3) Y, X, W, Z
 - 4) Z, W, X, Y
28. Which of the following correctly shows the exchange of gases between living things and the environment when there is light?

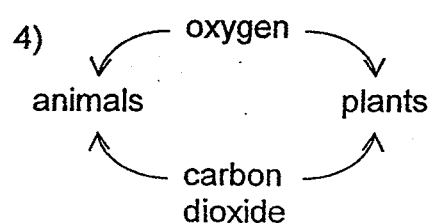
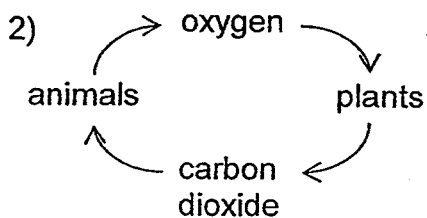
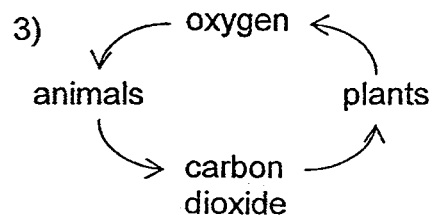
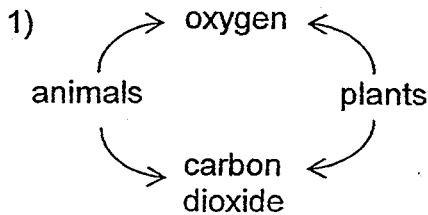

29. Brenda wanted to conduct an experiment to find out if light travels in straight lines. She placed 4 items inside a brightly lit room and she stood outside the room.

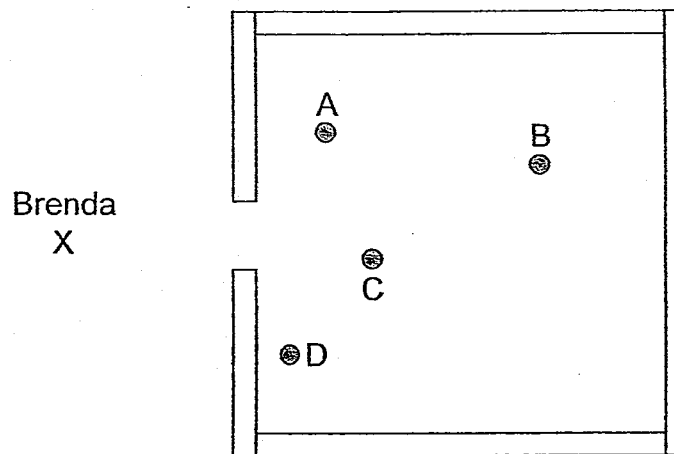

Which object/s could Brenda see?

- 1) C only
 2) A and C only
 3) B and C only
 4) B, C and D only
30. Kong Wah wanted to make a screen to project a movie. He took 4 materials and to test if they were suitable. He used a data-logger to help him detect the amount of light. The setup for the experiment was as follows:

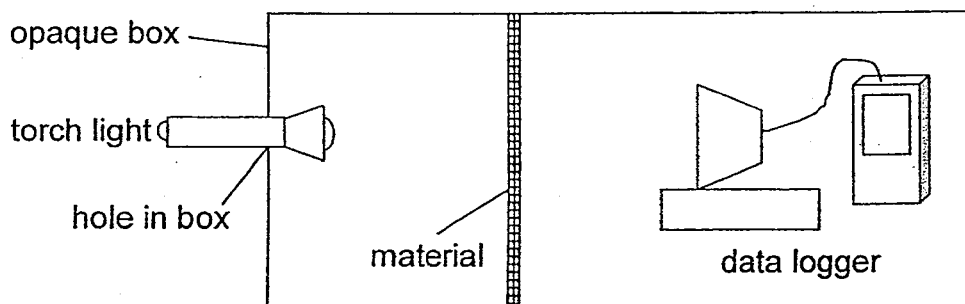

The following table shows his results.

Material	Amount of light detected (lux)
P	410
Q	330
R	180
S	0

Based on Kong Wah's results, which one of the materials will be most suitable to be made into a screen to project a movie?

- 1) P
 2) Q
 3) R
 4) S

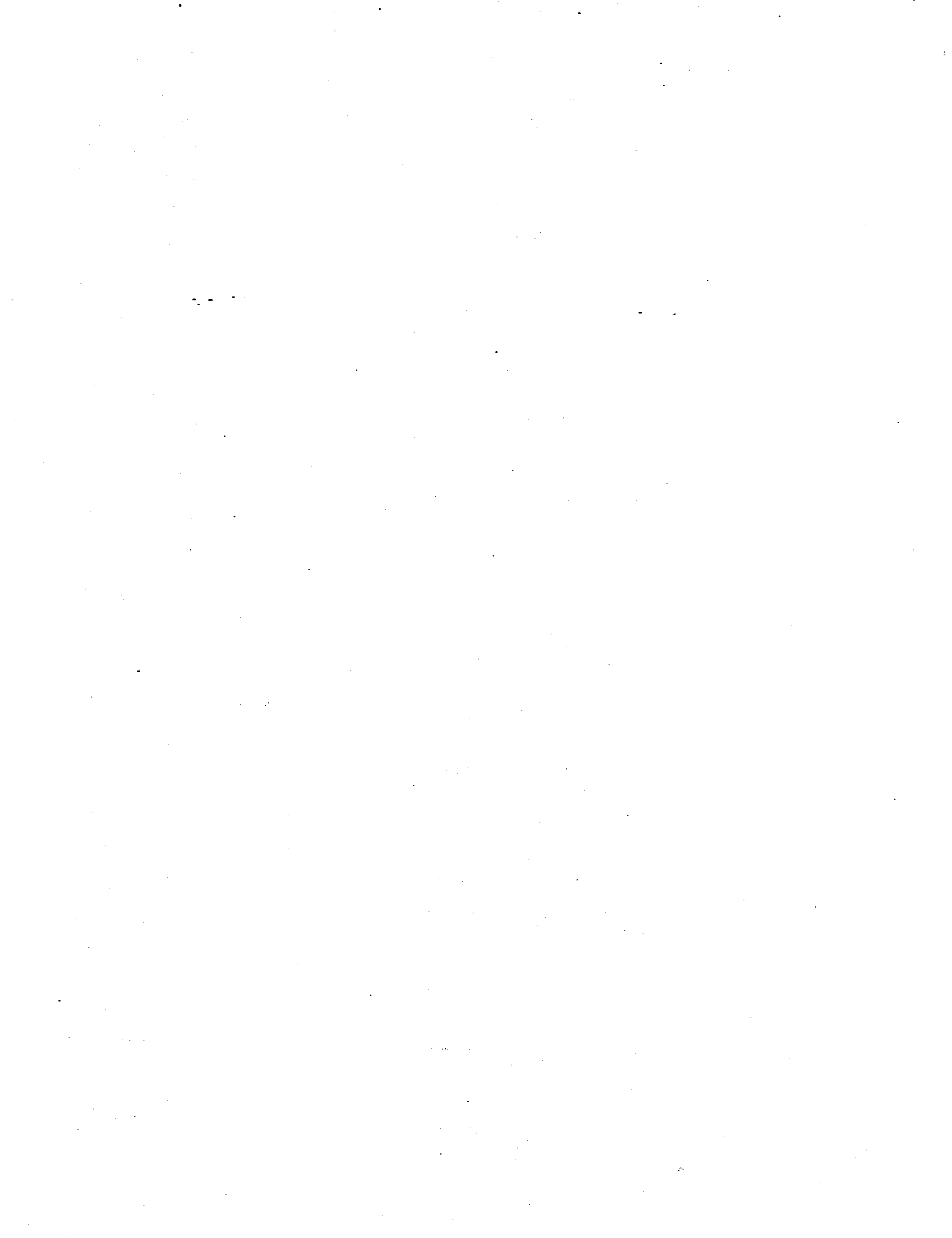

SINGAPORE CHINESE GIRLS' SCHOOL
SECOND SEMESTRAL ASSESSMENT 2015

SCIENCE
PRIMARY FIVE

NAME: _____ ()

DATE: _____

CLASS: PRIMARY 5

Booklet A		60
Booklet B		40
Total		100

Parent's Signature _____

BOOKLET B

14 questions

40 marks

Total time for Booklets A & B: 1 h 45 min

DO NOT OPEN THIS BOOKLET UNTIL YOU ARE TOLD TO DO SO.

FOLLOW ALL INSTRUCTIONS CAREFULLY.

Name: _____ ()

Date: _____

Class: Primary 5

Part II (40 marks)

Answer all the following questions.

31. Study the classification table below.

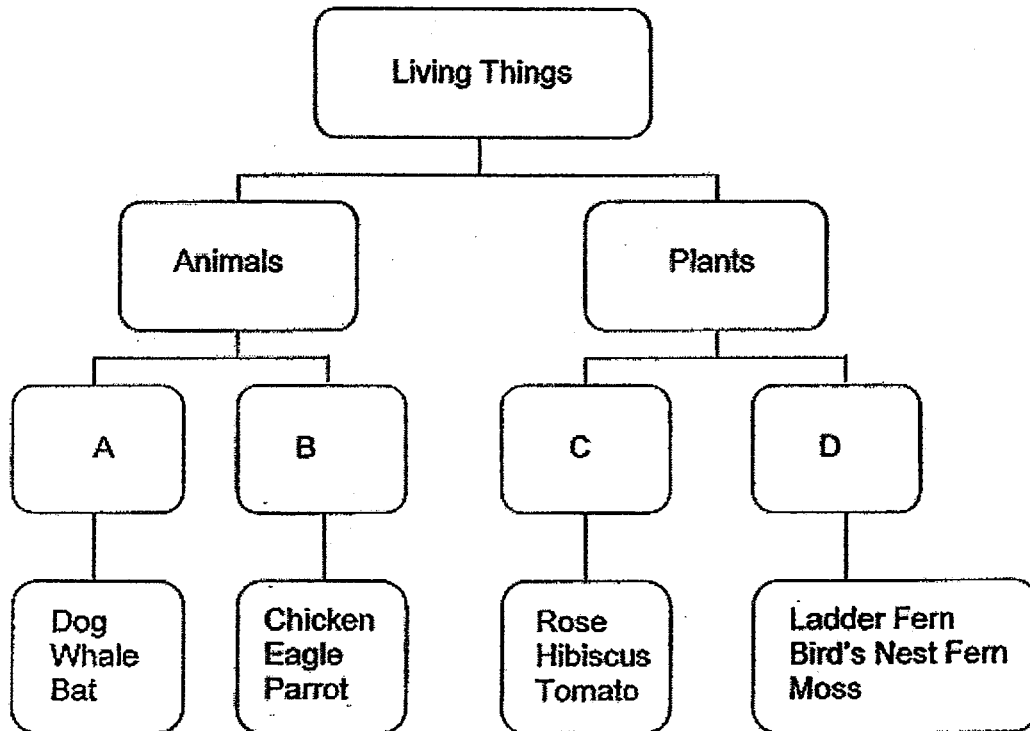

a) What are the suitable headings for A, B, C and D respectively? (2m)

A: _____ C: _____

B: _____ D: _____

b) Under which heading should these living things be classified? Write the letters A, B, C or D in the boxes provided. (1m)

Penguin

Mango

32. Study the flow chart below. It shows the characteristics of some cells, A, B and C.

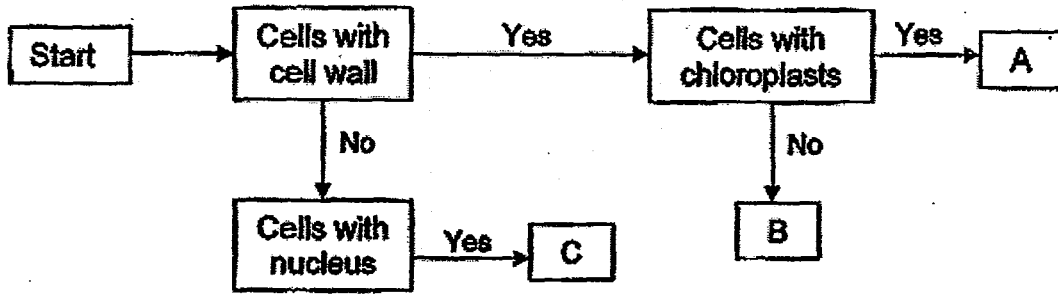

Match the following cells to A, B and C. (3m)

	Cell
a) Onion cell	
b) Human cheek cell	
c) Green leaf cell	

33. Ahmad took a plant from the soil and placed it in a beaker of red-coloured water.

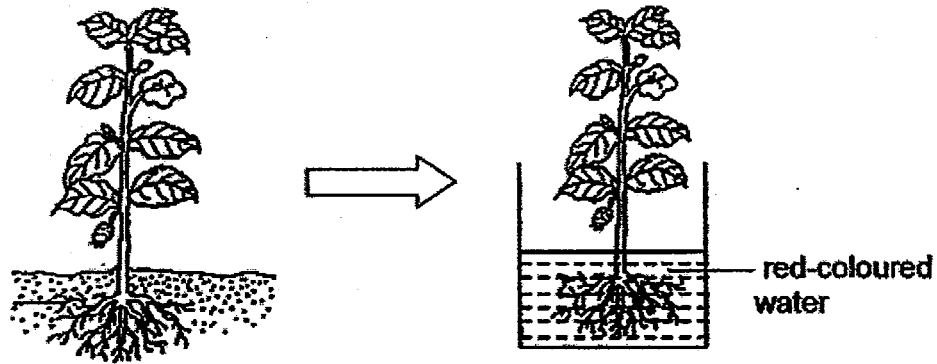

a) Explain why the leaves and flowers turned red after 1 day. (1m)

b) Ahmad conducted another experiment as shown below.

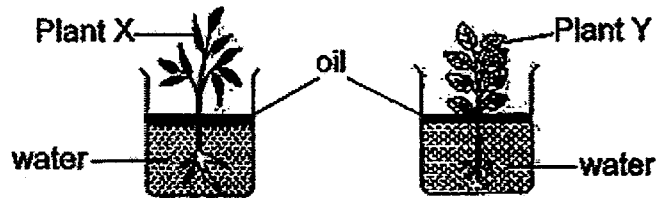

i) What is the aim of his experiment? (1m)

ii) State the purpose of the layer of oil in the beakers. (1m)

34. Three different circuits are set up, each with 2 switches, 2 identical bulbs and 2 identical batteries.

For each setup, write "S1" for Switch 1 and "S2" for Switch 2 in the boxes provided on the circuit to show where the switches should be placed based on the results. (3m)

Setup 1	S1	S2	No. of bulbs lit up
Result	Open	Closed	1

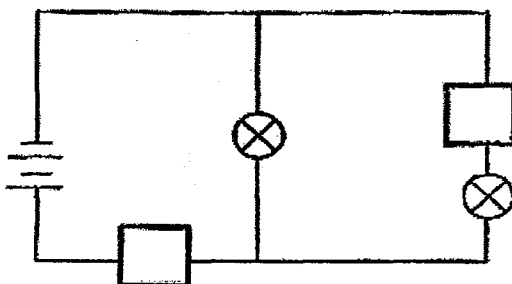

Setup 2	S1	S2	No. of bulbs lit up
Result	Closed	Open	2

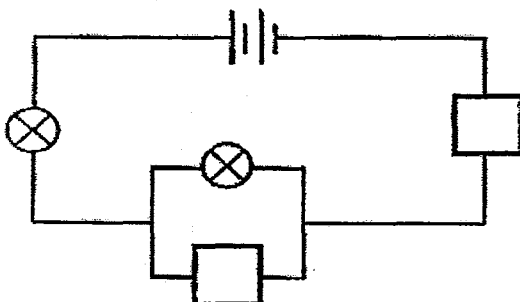

Setup 3	S1	S2	No. of bulbs lit up
Result	Open	Closed	0

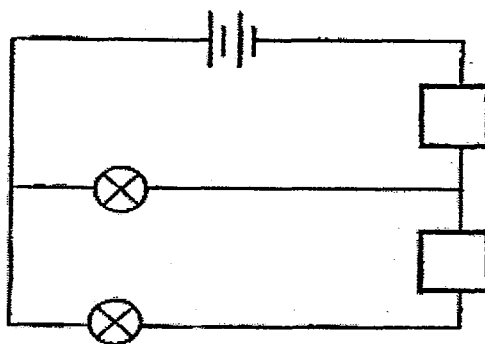

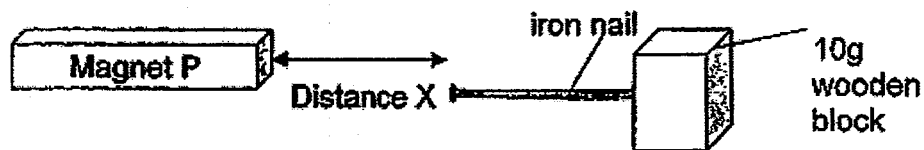

35. Albert conducted an experiment. He placed a magnet, P, near an iron nail that is attached to a 10g wooden block.



He measured Distance X which is the greatest distance between the magnet and the iron nail for attraction to take place. The results are shown in the table below.

Harry then repeated the experiment with Magnets Q and R.

Magnet	Distance X (cm)
	4
	2
	3

- a) What does the above experiment show about the strength of a magnet and its size? (1m)

- b) Albert then repeated the experiment using an iron nail on a 20g wooden block and Magnet P. What will happen to Distance X? (1m)

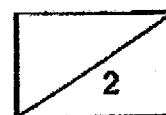

36. The diagrams below show the life cycles of 2 animals.

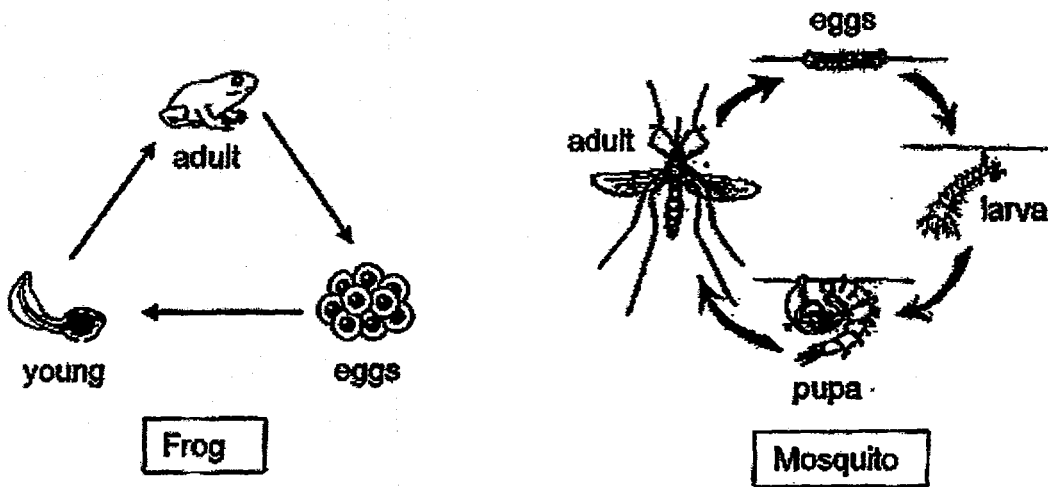

a) State 2 differences between the life cycles of the 2 animals above. (2m)

- (1) _____

- (2) _____

b) The frog and mosquito both lay eggs in water. State another similarity between the life cycles of the 2 animals. (1m)

37. The following diagram shows how seeds of plants X, Y and Z are dispersed.

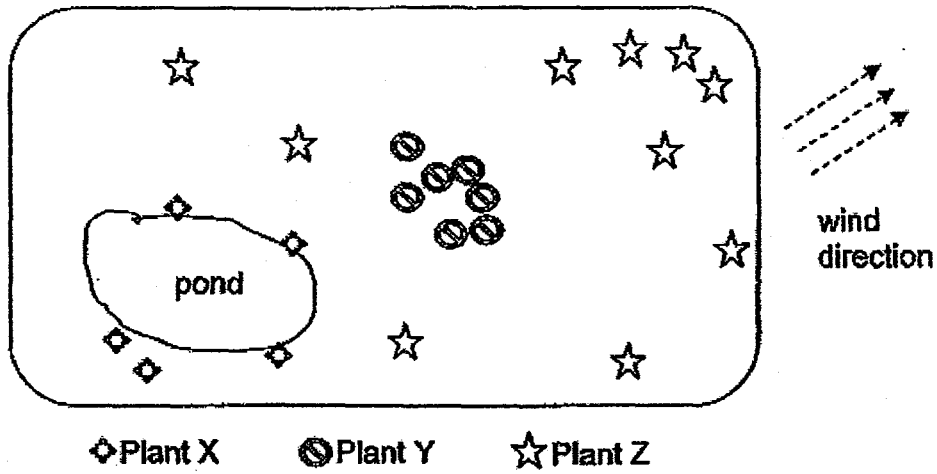

a) Based on the above diagram, what is the most likely dispersal method for Plant X? (1m)

b) Name 1 characteristic of the fruit / seed dispersed by the method as mentioned in Part (a) (1m)

c) What could be the most likely dispersal method for Plant Z? (1m)

38. Jason heard a fable about a crow that wanted to drink from a bottle of water but was not able to do so because the neck of the bottle was too small for its beak. The crow dropped stones into the bottle and the water rose so it was able to drink the water.

Jason wanted to conduct an experiment to find out if what the crow did really worked. He set up the experiment as shown below. The diagrams showed what the water level was before and after the stones were dropped into the bottle.

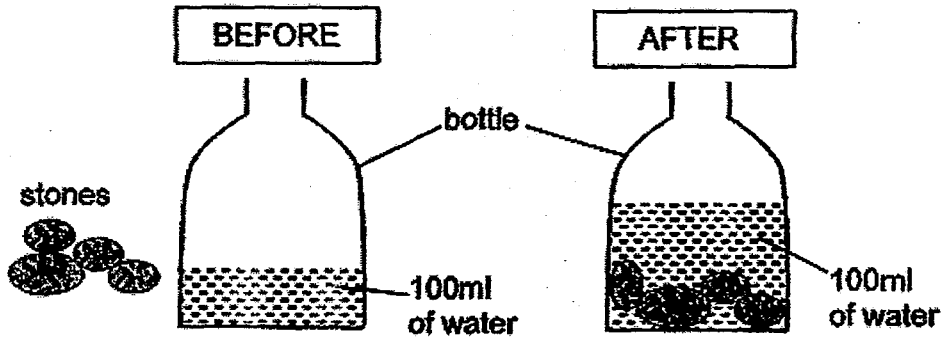

- a) Why did the water level rise when the amount of water did not change? (1m)

- b) Jason conducted another experiment as shown below.

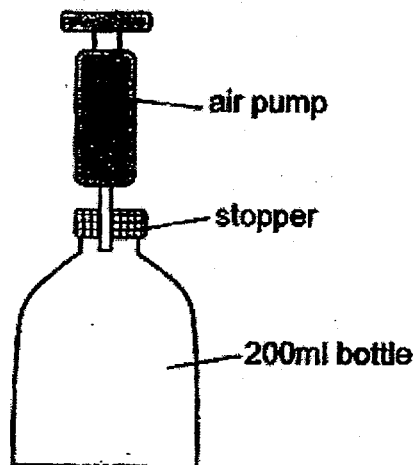

Jason was able to pump 250ml of air into the bottle even when the capacity of the bottle is 200ml, explain why he was able to do that. (1m)

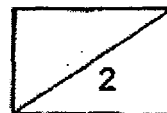

39. Rosie poured some ice water into a beaker as shown in the diagram below. The room temperature at that time was 32°C .

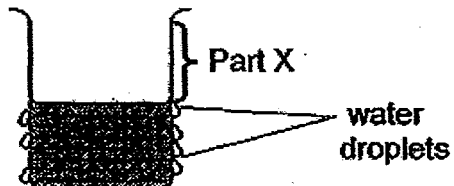

- a) Why are there no water droplets formed on Part X of the beaker as shown in the above diagram? (2m)

- b) When the water in the beaker reached room temperature, Rosie decided to heat it. She plotted a graph as shown below.

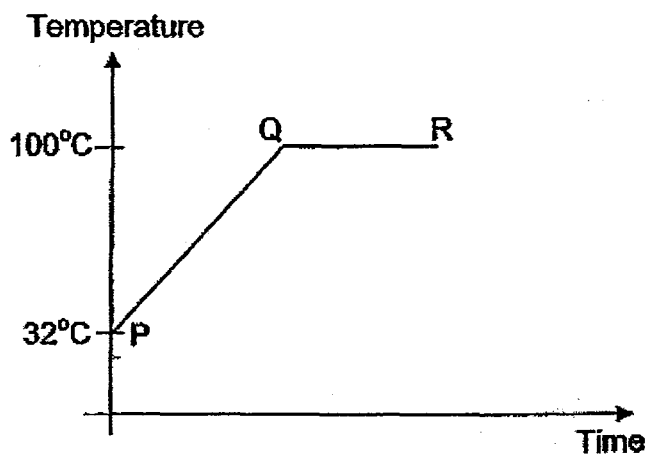

- Explain why the temperature of the water did not change between Q and R. (1m)

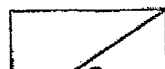

40. Josh conducted an experiment. He poured equal amounts of 2 different liquids, A and B, into Beaker A and B respectively. Both beakers were left on a table beside an open window for 2 days.

2 days later, Josh observed that there were changes in the amount of liquid in the beakers. He recorded the changes in a table below.

Liquid	Amount of liquid (Start of the experiment)	Amount of liquid (after 2 days)
A	150 ml	126 ml
B	150 ml	109 ml

- a) Put a tick (✓) in the correct boxes to indicate whether the statements are True, False or Not Possible to Tell. (2m)

Statements	True	False	Not Possible to Tell
Liquid B evaporated faster than Liquid A.			
Liquid A has a higher boiling point than Liquid B.			
There was less liquid in Beaker A than in Beaker B at the start of the experiment.			
Beaker B will be empty before Beaker A.			

- b) Josh conducted another experiment with 3 trays of different sizes containing the same amount of water at 30°C.



P

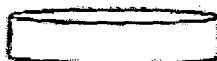

Q

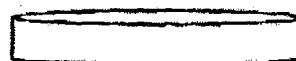

R

From which tray will the water evaporate at the fastest rate? Explain your answer. (1m)

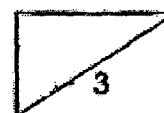

42. Cathy carried out an experiment at room temperature 32°C . She bent 5 thin metal rods as shown in the diagram below.



Cathy then placed the rods into 2 cups, Cup A was filled with hot water and Cup B was filled with cold water as shown below.

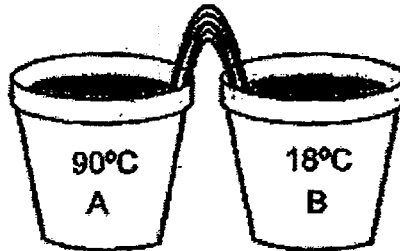

- a) What would happen to the temperature of the water in Cup A and Cup B after 2 minutes? Write 'Increase' or 'Decrease' in the table below. (1m)

Water in	Will the temperature increase or decrease?
Cup A	
Cup B	

Cathy then repeated the experiment but she removed 4 rods and left only 1 rod in the cups as shown below.

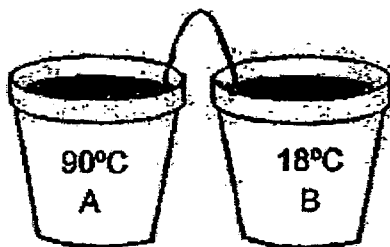

- b) In what way would the time taken for the water to change its temperature be affected by the reduction of rods? (1m)

- c) What would be the temperature of the water in the cups after 3 hours? (1m)

Cup A

Cup B

43. The diagram below shows 3 similar containers, A, B and C, each containing 200ml of water. Container A was placed on its own and Containers B and C are placed side by side touching each other. The temperature of water is 50°C in Container A, 50°C in Container B and 85°C in Container C. They were placed in a room of 25°C.

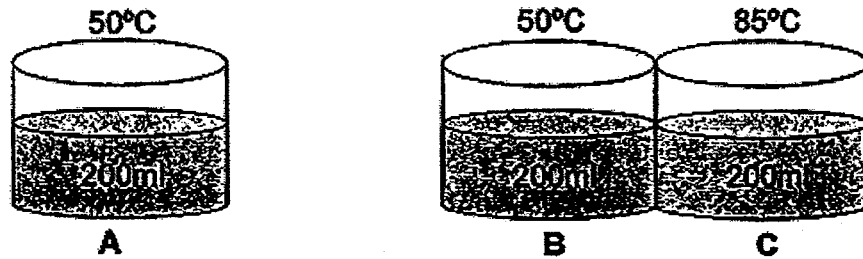

The containers of water were left to cool for 60 minutes.

- a) Based on the above information, write A or B in the boxes provided on the graph below to indicate the line that represents the respective containers of water. (1m)

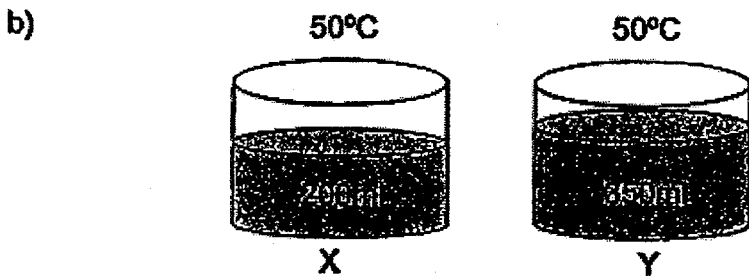
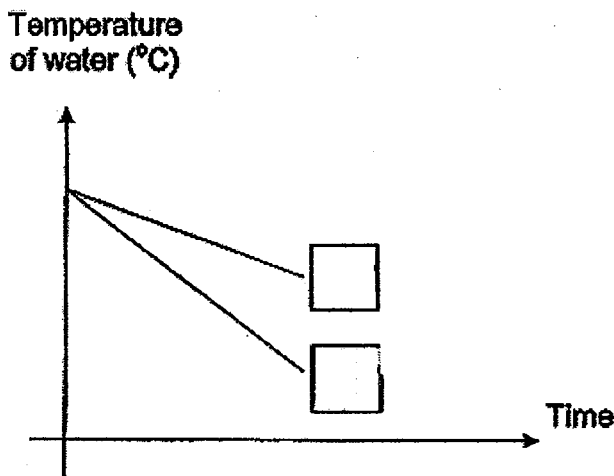

Does the water in Y have a smaller, same amount or greater amount of heat than X? Explain your answer. (2m)

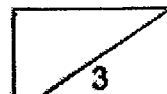

44. Object X is made up of an opaque cylinder and 2 transparent extension rods, one on each side. A torch is shone on it to form a shadow on the screen.

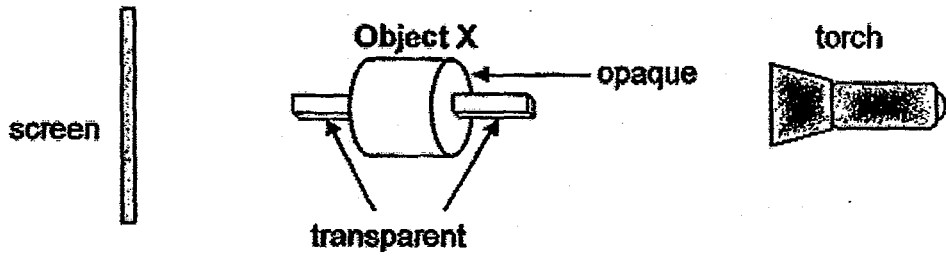

a) In order to form a bigger shadow, how should Object X be moved? (1m)

b) Object X is placed at 2 positions, A and B, to form different shadows.

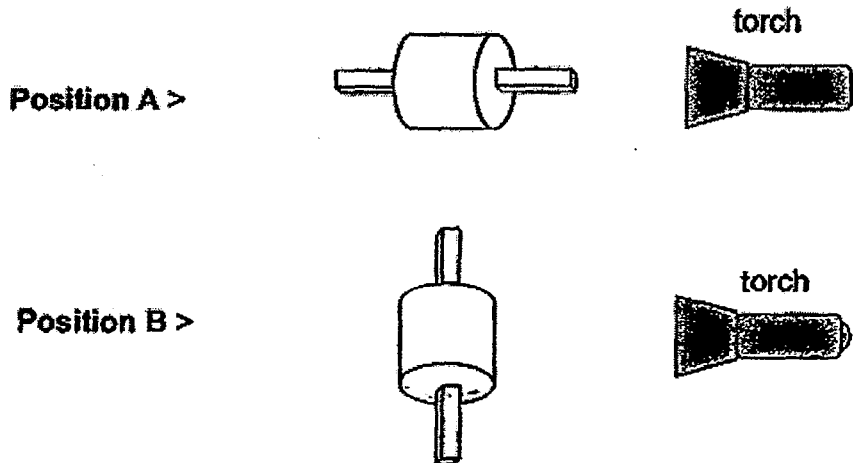

Draw the possible shadows that will be formed on the screen in the given boxes provided.

Please **SHADE Completely** for the shadows. (2m)

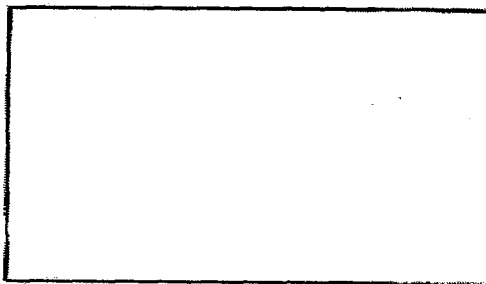

Shadow formed with Position A

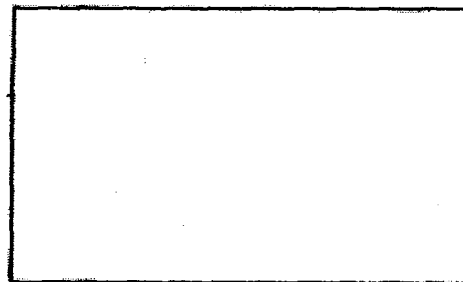

Shadow formed with Position B



SINGAPORE CHINESE GIRLS' SCHOOL
PRIMARY 5 SCIENCE SA2 2015 Model Answers

Booklet A

1) 2	6) 4	11) 3	16) 4	21) 4	26) 1
2) 3	7) 4	12) 2	17) 2	22) 3	27) 3
3) 2	8) 4	13) 1	18) 1	23) 2	28) 3
4) 3	9) 3	14) 3	19) 4	24) 3	29) 3
5) 1	10) 3	15) 2	20) 4	25) 1	30) 4

Booklet B

Qn	Suggested Answer			
	A	B	C	D
31a	Mammals	Birds	Flowering plants	Non-flowering plants
31b	Penguin – B, Mango – C			
32	a) B b) C c) A			
33a	The water carrying tubes have transported the red-coloured water to the other parts of the plants and stained them red.			
33bi	To find out if different types of plants take in different amounts of water			
33bii	The purpose of the layer of oil in the beakers is to prevent the water from evaporating which will affect the results of the experiment.			
34				
35a	The strength of a magnet does not depend on its size.			
35b	Distance X will become shorter.			
36a	1) The frog has a 3-stage life cycle while the mosquito has a 4-stage life cycle. 2) The young of the frog does not moult while the young of the mosquito moults.			
36b	Their young do not look like their adult. / They spent part of their life cycles in water and part of their life cycle on land.			
37a	They are dispersed by water.			
37b	Has fibrous husk to allow it to float on water			
37c	Dispersed by wind / dispersed by animals			
38a	The stones are solid and they have a definite volume.			
38b	Air can be compressed. / Air does not have a definite volume.			
39a	The surface of Part X is not cool enough for the warmer water vapour in the surrounding to condense into water droplets.			
39b	The water has reached its boiling point.			

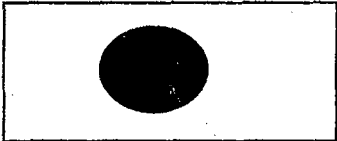
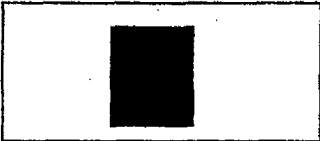
	Statements	True	False	Not Possible to Tell
40a	Liquid B evaporated faster than Liquid A.	✓		
	Liquid A has a higher boiling point than Liquid B.			✓
	Liquid A has less water at the start of the experiment.		✓	
	Beaker B will be empty before Beaker A.	✓		
40c	Tray R. The exposed surface area of the water is the largest.			
41a	(i) clear			
	(ii) Mushrooms are not plants so they do not photosynthesise and do not give out oxygen.			
41b	(i) pink			
	(ii) The plant will carry out photosynthesis in the presence of light and give out oxygen.			
42a	Cup A – decrease			
	Cup B – increase			
42b	The time taken will be longer.			
42c	Cup A – 32°C			
	Cup B – 32°C			
43a	B			
	A			
43b	Water in Y has a greater amount of heat because it has a greater volume.			
44a	Object X must be moved nearer to the torch. /			
	Object X must be moved further from the screen.			
44b				
				
	Position A		Position B	