



**RAFFLES GIRLS' PRIMARY SCHOOL  
SEMESTRAL ASSESSMENT 1  
2015**

Section A	60
Section B	40
Your score out of 100 marks	
Parent's signature	

Name : \_\_\_\_\_ Index No: \_\_\_\_\_ Class: P5 \_\_\_\_\_

**7 May 2015**

**SCIENCE**

**Att: 1 h 45 min**

**SECTION A (30 x 2 marks)**

For each question from 1 to 30, four options are given. One of them is the correct answer. Make your choice (1, 2, 3 or 4). Shade the correct oval (1, 2, 3 or 4) on the Optical Answer Sheet (OAS) provided.

1. Siti observed Plant Z over a period of 15 days.

The diagrams below show how plant Z looked like on Day 5, 10 and 15.

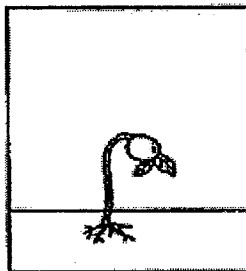

**Day 5**

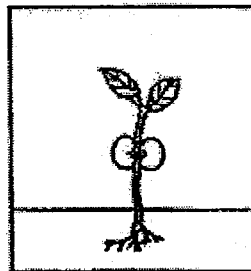

**Day 10**

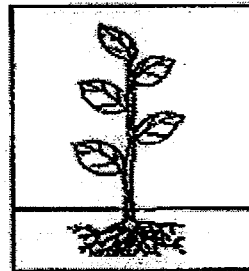

**Day 15**

Based on the information above, which one of the following statements describes the characteristic of living things shown by plant Z?

- (1) They die.
- (2) They grow.
- (3) They reproduce.
- (4) They are able to move by themselves.

Answer questions 2 and 3 based on the information below.

The flow chart below shows how four groups of organisms, A, B, C and D are classified.

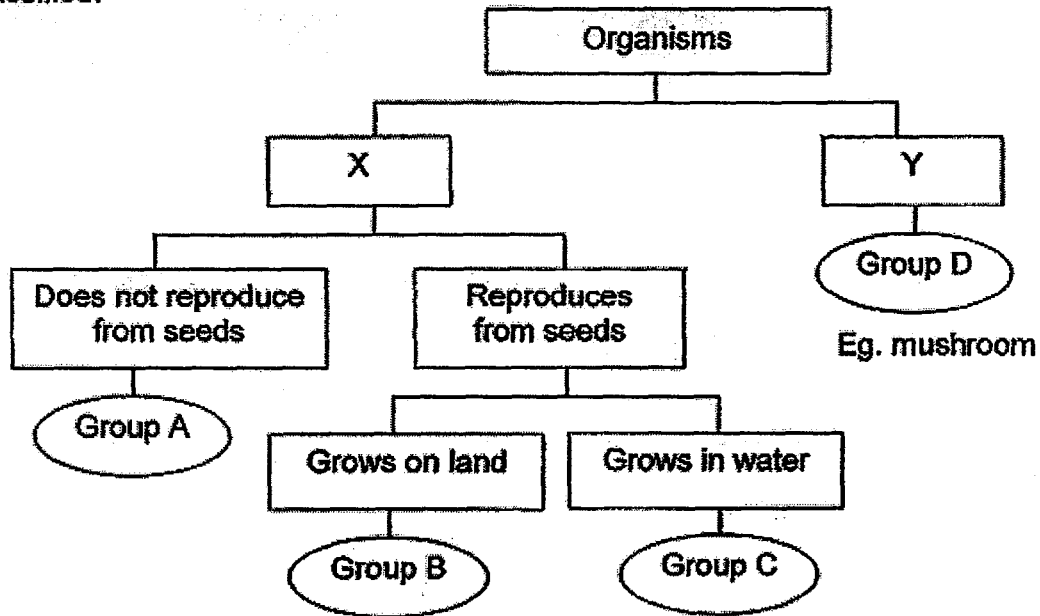

2. Which one of the following correctly describes characteristics X and Y?

	X	Y
(1)	Grows on land	Grows in water
(2)	Does not make its own food	Makes its own food
(3)	Produces flowers	Does not produce flowers
(4)	Has chlorophyll	Does not have chlorophyll

3. The table below shows some characteristics of plants P, Q and R. A tick (✓) indicates the presence of the characteristic in the plant.

Characteristics	Plant P	Plant Q	Plant R
Grows on land	✓		✓
Has fruits	✓	✓	
Reproduces by spores			✓

Based on the information above, which of the following plants can be placed in Group B?

- (1) P only
- (2) P and Q only
- (3) P and R only
- (4) P, Q and R

4. Study the flow chart below.

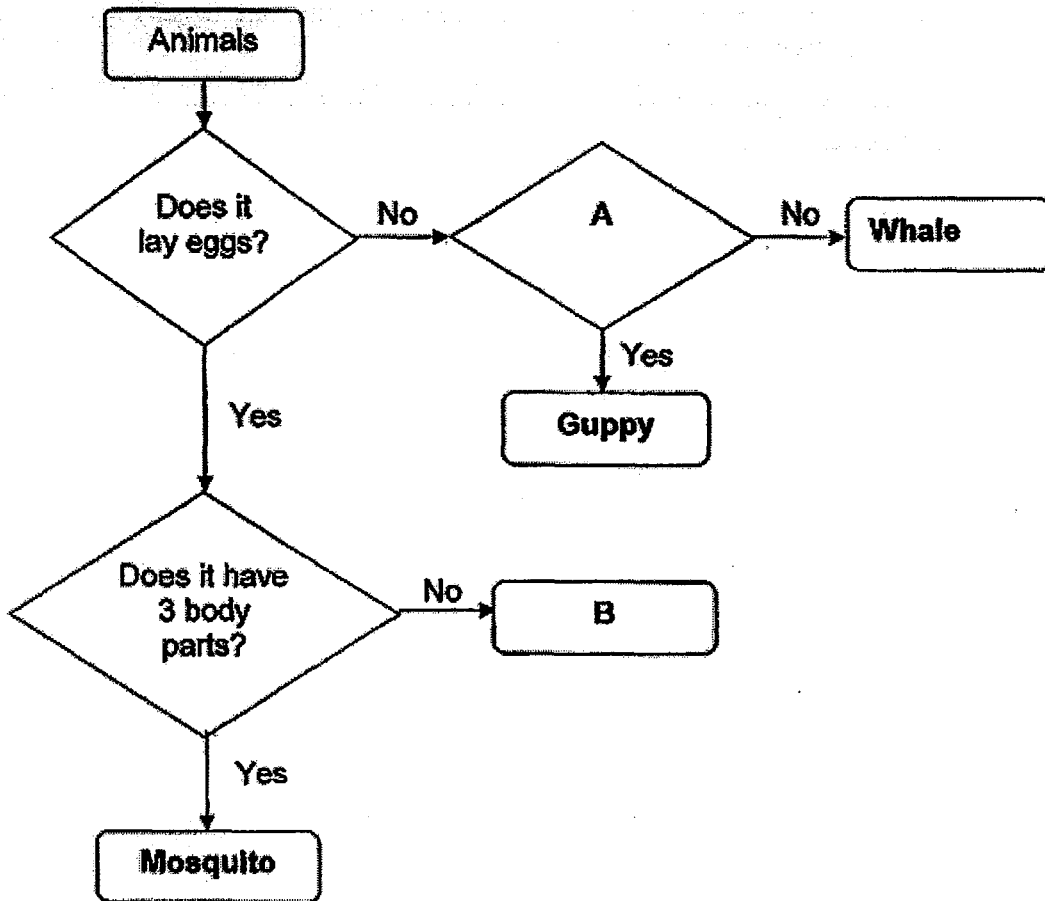

Which of the following correctly shows what Question A and Animal B could be?

	A	B
(1)	Does it have hairs?	Ant
(2)	Does it breathe through lungs?	Chicken
(3)	Does it have scales?	Bat
(4)	Does it breathe through gills?	Spider

5. John wanted to investigate the effect of light on the growth of bread mould.

He prepared four set-ups A, B, C and D and placed them in different locations as shown in the diagrams below.

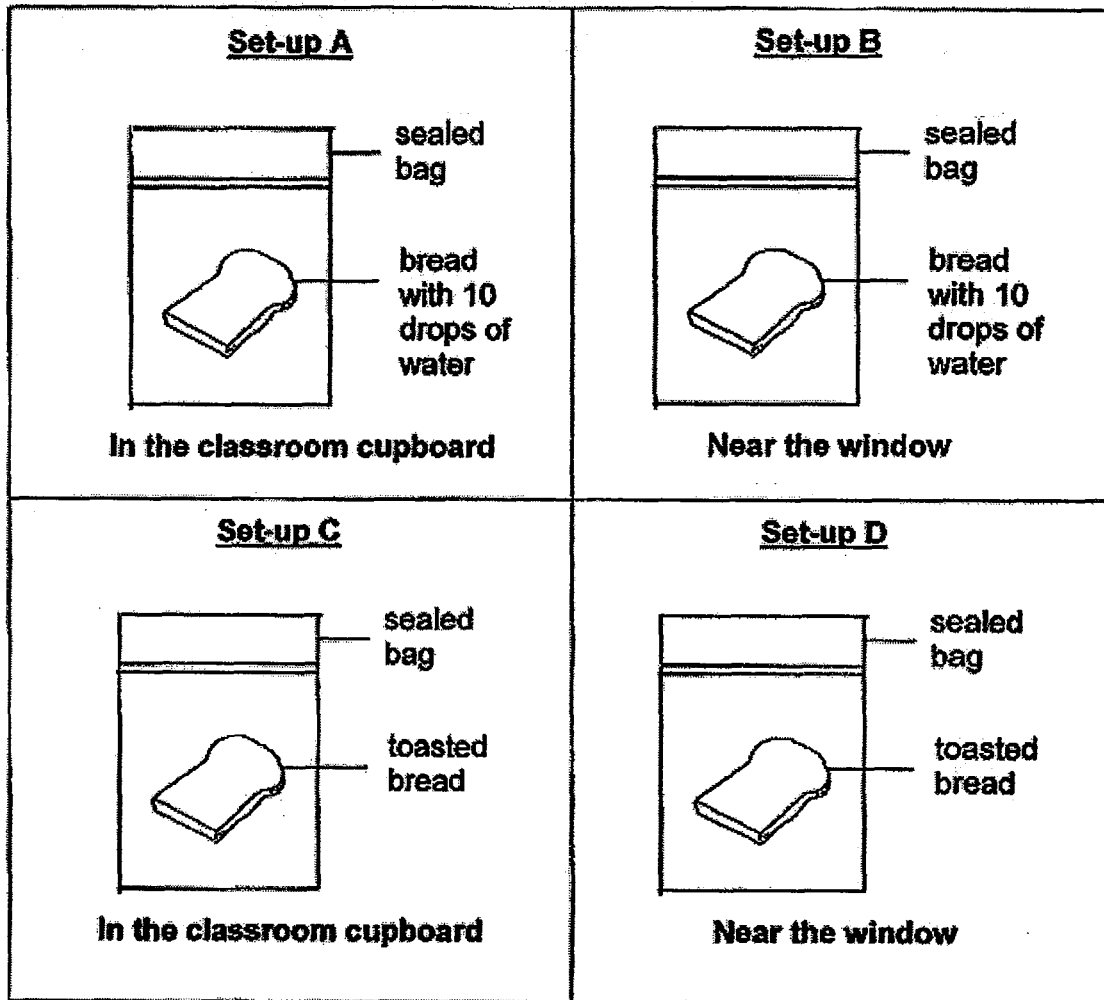

Which of the following set-ups should he compare in order to draw a correct conclusion?

- (1) A and B
- (2) A and C
- (3) B and D
- (4) C and D

6. Three pupils made a few statements about animals with 4-stage life cycle.

Abigail : The young does not look like the adult.

Bernard : During its larval stage, the organism does not feed at all.

Cindy : All insects have 4-stage life cycle.

Whose statement(s) is/are **incorrect**?

- (1) Abigail only
- (2) Bernard only
- (3) Abigail and Cindy only
- (4) Bernard and Cindy only

7. The graph below shows the number of days for each stage of life cycle of animals X and Y.

Number of days

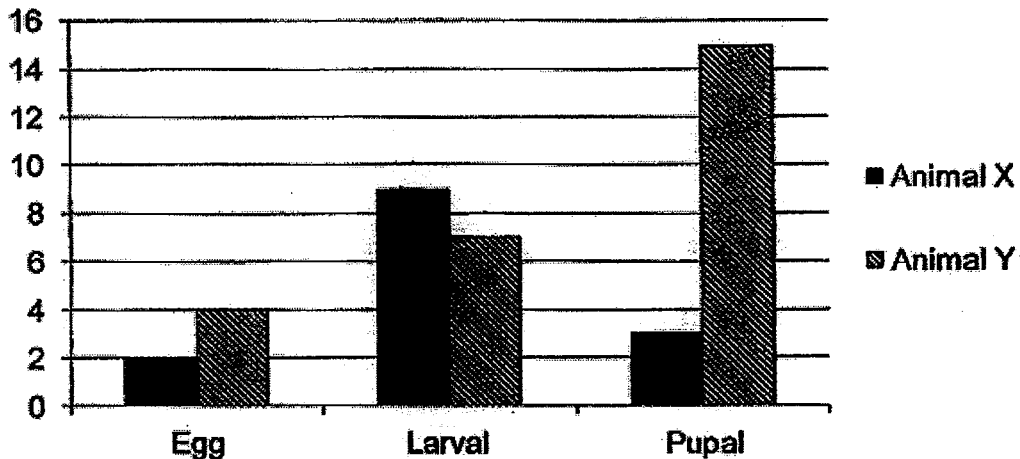

Based on the graph above, which stage would animals X and Y be on the 10<sup>th</sup> day after the egg was laid?

	Animal X	Animal Y
(1)	Larval	Larval
(2)	Larval	Pupal
(3)	Pupal	Larval
(4)	Pupal	Pupal

8. The diagram below shows the different stages in the life cycle of a flowering plant.

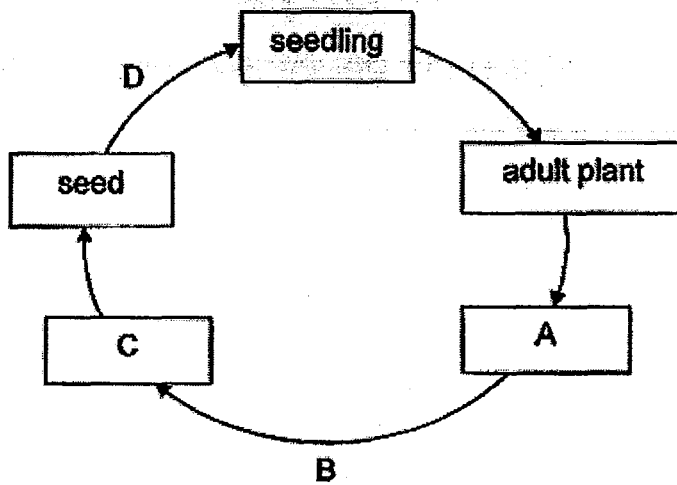

Which one of the following correctly identifies A, B, C and D?

	A	B	C	D
(1)	flower	pollination	fruit	fertilisation
(2)	flower	fertilisation	fruit	germination
(3)	fruit	dispersal	flower	pollination
(4)	fruit	germination	flower	dispersal

9. The diagrams below show two flowers of the same type.

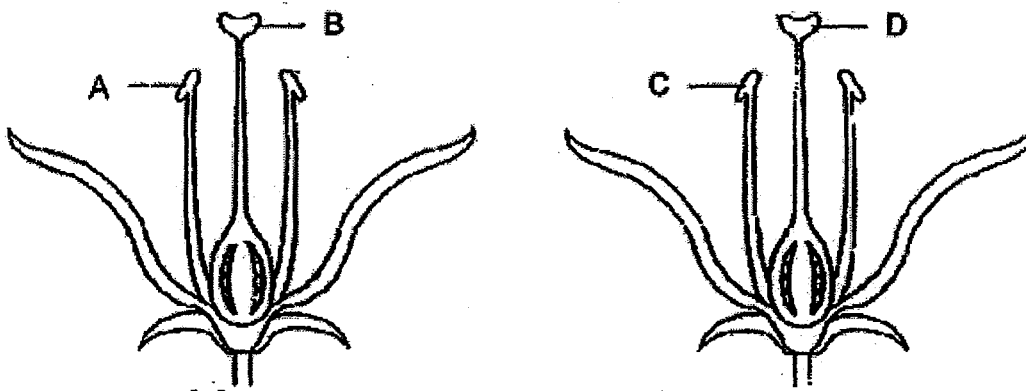

Which one of the following shows how pollen grain is transferred?

- (1) A to C
- (2) B to A
- (3) C to B
- (4) D to B

10. The diagram below shows the female reproductive system of a human.

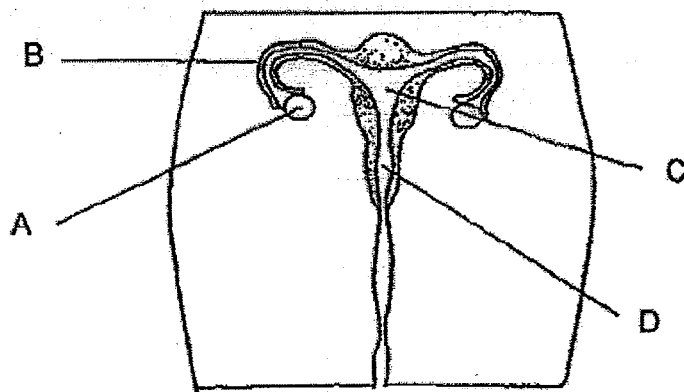

Which of the following parts are the eggs stored?

- (1) A
- (2) B
- (3) C
- (4) D

11. The diagram below shows part of Justin's family tree.

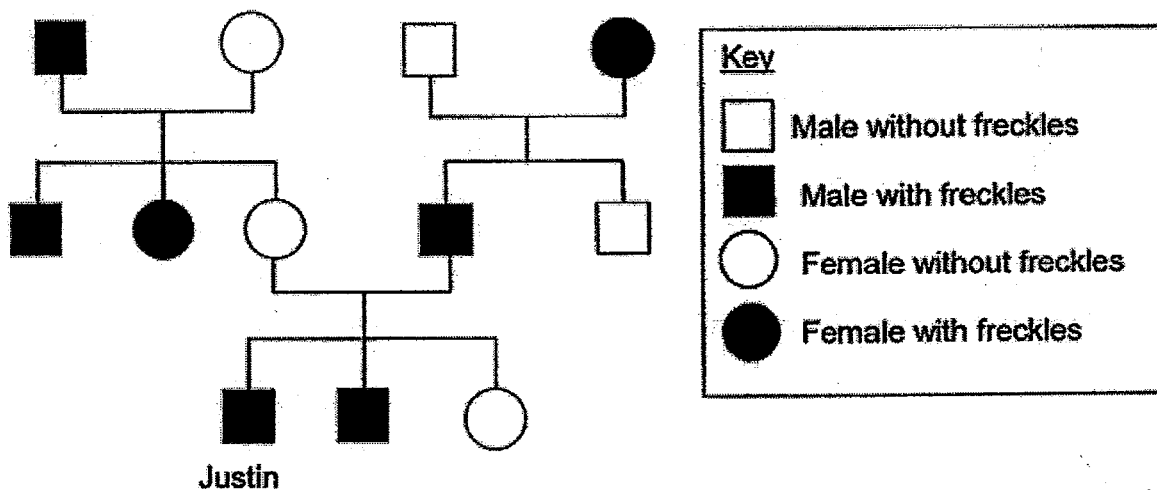

Which one of the following statements about the family tree is correct?

- (1) One of Justin's parents has freckles.
- (2) Both Justin's grandmothers have freckles.
- (3) Both Justin's brother and sister have freckles.
- (4) Justin's father has a brother who has freckles.

12. The table below shows the comparison between the male and female reproductive systems in a human.

	Reproductive organ	Reproductive cell
Female	Ovary	W
Male	X	Sperm

Which of the following correctly represents W and X?

	W	X
(1)	Testis	Womb
(2)	Sperm	Ovary
(3)	Egg	Testis
(4)	Womb	Egg

13. Melissa carried an experiment using four insect-pollinated flowers from the same plant. At the start of the experiment, different parts of the four flowers were removed as shown in the table below. The other flowers on the same plant were left intact.

Flowers	Anthers	Stigma	Ovary
W	Removed	Present	Present
X	Removed	Removed	Present
Y	Present	Present	Present
Z	Present	Removed	Removed

Melissa observed that insects visited the flowers over the following two weeks.

Which of the following flowers would most likely develop into fruits?

- (1) W and Y only
- (2) W and X only
- (3) X and Z only
- (4) Y and Z only



14. Tracy counted the number of plants, X, Y and Z on a piece of land. One year later, she counted the plants on the same piece of land again. Her observations are shown below.

**First observation**

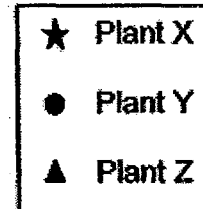
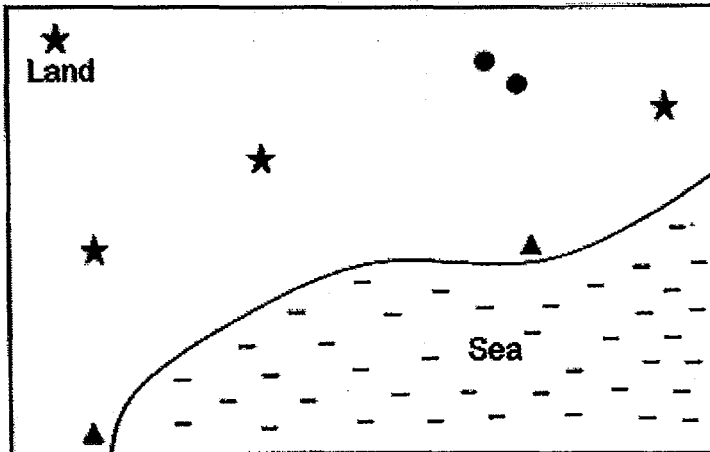

**After one year**

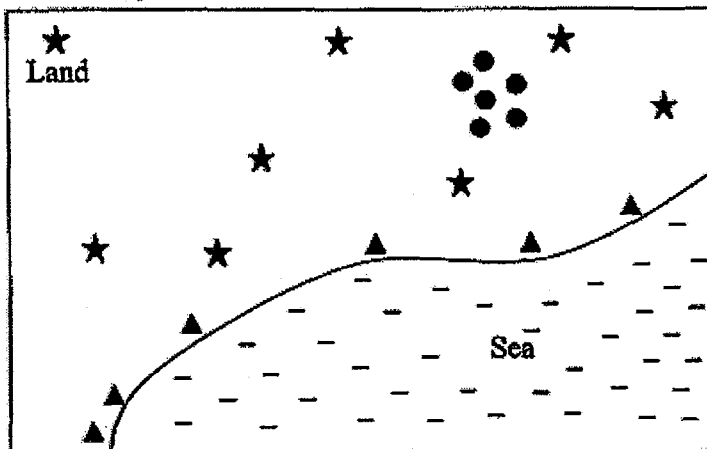

Which one of the following shows how the seeds of plants X, Y and Z are dispersed?

	Plant X	Plant Y	Plant Z
(1)	Splitting	Animals	Wind
(2)	Wind	Water	Animals
(3)	Animals	Splitting	Water
(4)	Water	Wind	Splitting

15. Some flowers, P, Q, R, S, T and U, are classified as shown below.

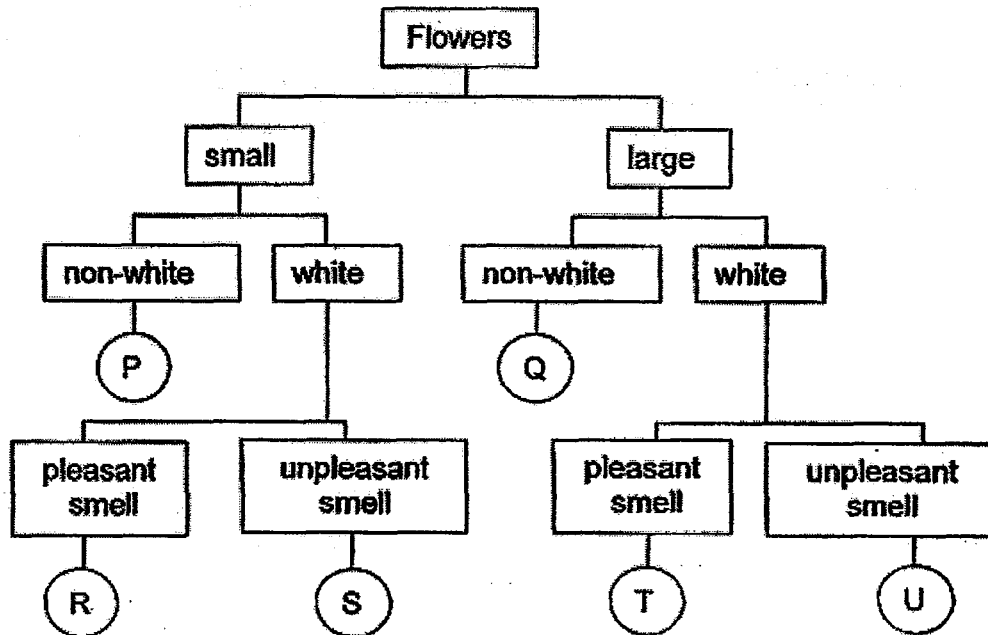

Animals A and B are pollinators for certain flowers. The table below shows the characteristics of flowers that animals A and B are attracted to.

Animal	Characteristics of flower that attract the animal
A	small, red, has a pleasant smell
B	large, white, has a pleasant smell

Which of the following flowers will attract animals A and B?

	Animal A	Animal B
(1)	P	T
(2)	Q	U
(3)	R	S
(4)	T	R

16. Cindy collected four samples, A, B, C and D, from different plants as shown below.

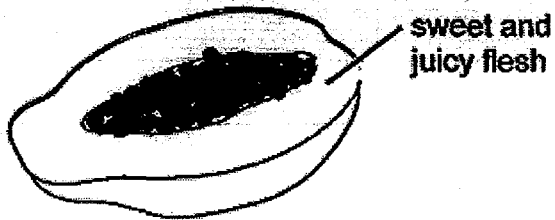

Sample A

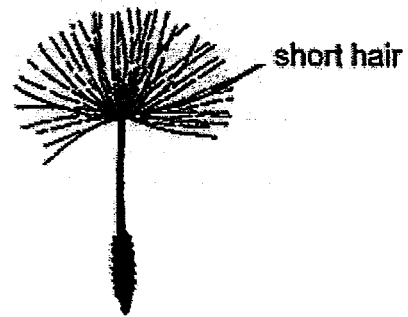

Sample B

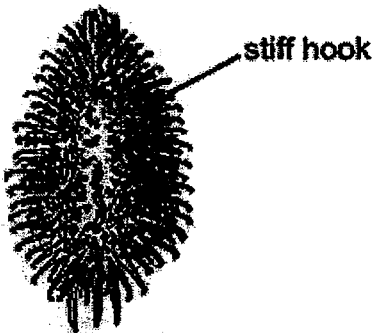

Sample C

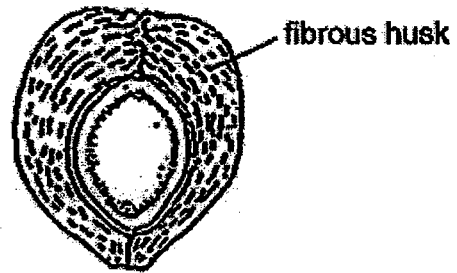

Sample D

She dropped the samples, one at a time, from a fixed height of 2 metres on a windy day.

Which one of the following sample will travel the greatest distance before landing on the ground?

- (1) A
- (2) B
- (3) C
- (4) D

17. The table below provides some information on four cells, A, B, C and D. A tick (✓) indicates the presence of that part in the cell.

Part	A	B	C	D
Nucleus	✓	✓	✓	
Cytoplasm	✓	✓	✓	✓
Chloroplast	✓			
Cell wall	✓	✓		
Cell membrane	✓	✓	✓	✓

Which one of the following are animal cells?

- (1) A and B only
- (2) A and C only
- (3) C and D only
- (4) B, C and D only

18. The diagrams below show two different types of cells, X and Y, taken from the same plant.

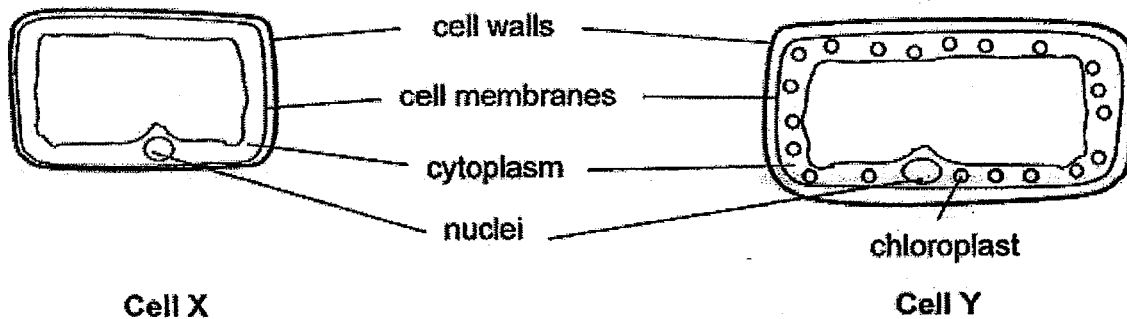

Which of the following correctly identifies the parts of the plant where cells X and Y, were most likely taken from?

	cell X	cell Y
(1)	leaf	root
(2)	root	leaf
(3)	fruit	root
(4)	leaf	fruit

19. Cassandra classified five objects as shown in the table below.

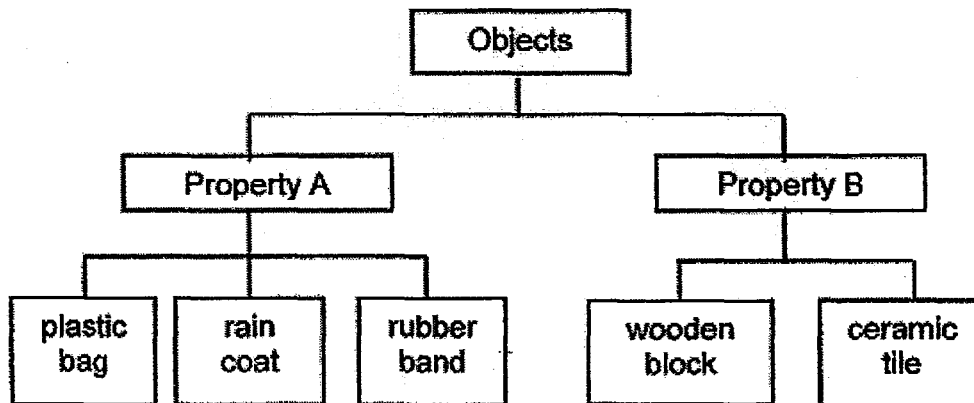

Which one of the following correctly identifies properties A and B?

	Property A	Property B
(1)	Flexible	Not flexible
(2)	Opaque	Transparent
(3)	Magnetic	Non-magnetic
(4)	Waterproof	Not waterproof

20. John conducted an experiment to study the hardness of three materials, A, B and C. He used the material in column X to scratch the material in column Y. He recorded his observations in the table below.

Column X	Column Y	Scratch marks observed on material in Column Y?
A	C	No
B	A	Yes
C	B	No
C	A	Yes

Which of the following correctly shows the three materials arranged in increasing order of hardness?

	Softest → Hardest		
(1)	A	C	B
(2)	B	C	A
(3)	B	A	C
(4)	C	A	B

21. John hung two identical metal balls, P and Q, to a rod as shown in the diagram below.

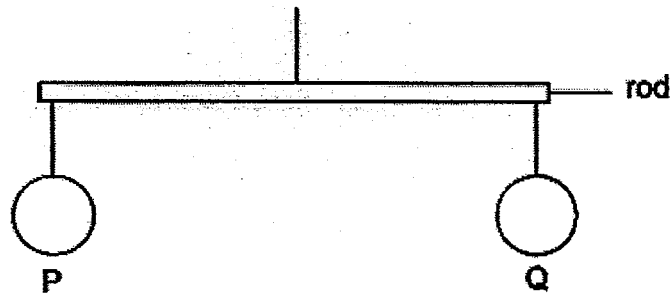

John heated ball P over a flame for 5 minutes.

Which of the following statements correctly describe what happened after ball P was heated?

- A Ball P will increase in mass.
- B Ball P will have a bigger volume than ball Q.
- C The rod will tilt downwards at the end where ball P is attached.

- (1) B only
- (2) A and C only
- (3) B and C only
- (4) A, B and C

22. The diagram below shows a syringe attached to container X.

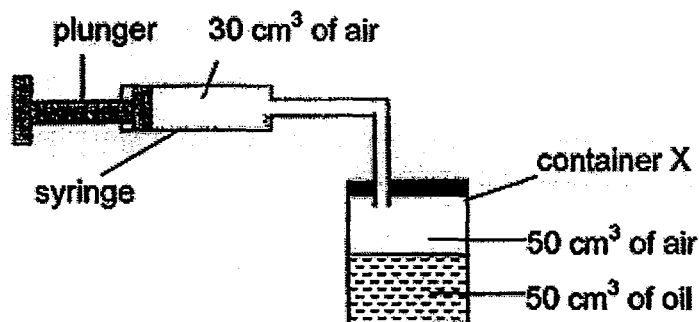

When the plunger was pushed into the syringe, 30cm<sup>3</sup> of air was added to container X.

Which of the following shows the changes in the volume of air, volume of oil and the total volume of air and oil in container X?

	Volume of air in container X	Volume of oil in container X	Total volume of air and oil in the container X
(1)	increased	increased	increased
(2)	remained the same	remained the same	remained the same
(3)	remained the same	increased	remained the same
(4)	increased	remained the same	increased

23. Jeremy poured 500 ml of water of the same temperature into each of the three plastic containers, A, B and C, as shown in the diagrams below.

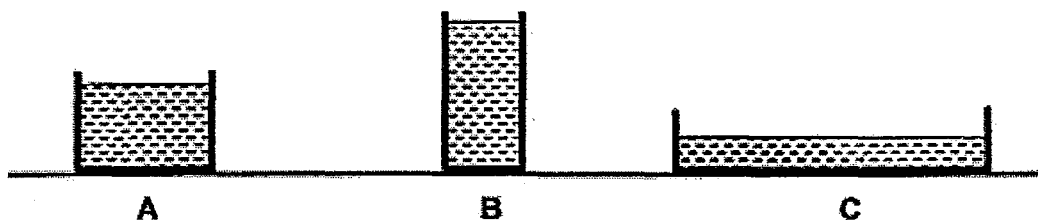

He placed the three containers at the same location and measured the amount of water left in each container after 6 hours.

Which one of the following would most likely be the amount of water left in each container?

	Container A	Container B	Container C
(1)	350 ml	400 ml	450 ml
(2)	450 ml	400 ml	350 ml
(3)	400 ml	350 ml	450 ml
(4)	400 ml	450 ml	350 ml

24. Amanda heated a kettle of water at  $30^{\circ}\text{C}$  over a stove. The water boiled after 10 minutes. It was left to boil for 10 minutes. She turned off the stove and left the water to cool in the room for 10 minutes. Then the water was further heated for another 10 minutes.

Which one of the following shows the changes in the temperature of the water in the kettle during the period of 40 minutes?

(1)

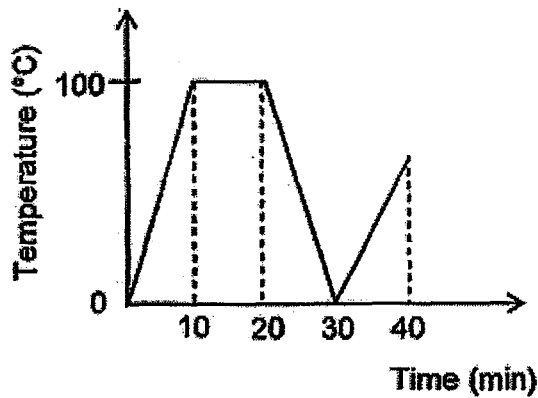

(2)

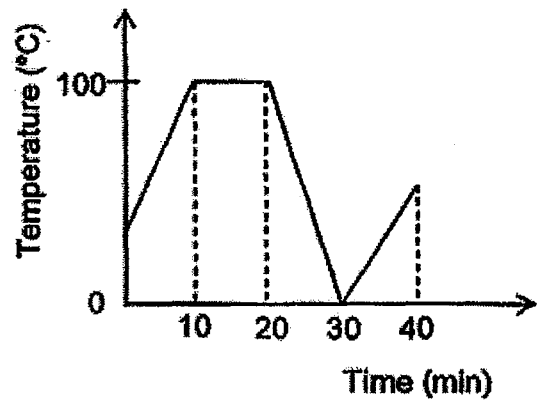

(3)

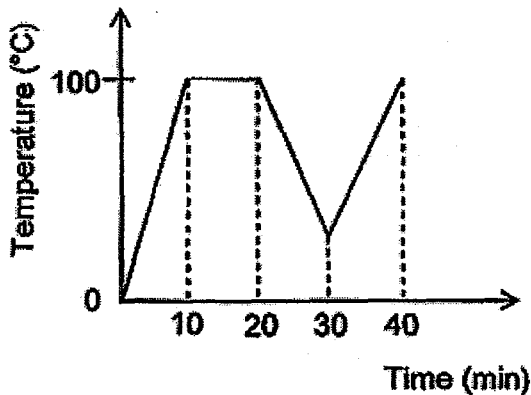

(4)

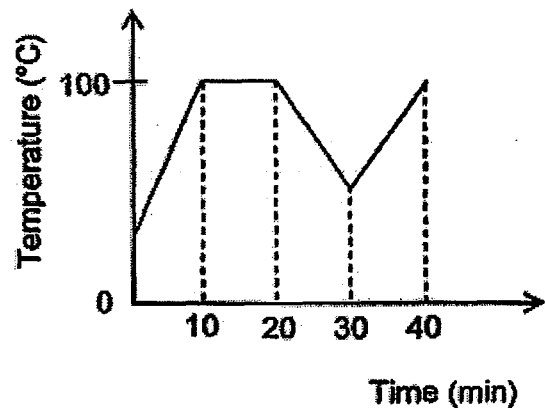



25. The following statements show the different phases in the water cycle that are not arranged in the correct sequence.

- A Water vapour rises and cools.
- B The clouds become heavier and heavier.
- C Rain falls to the earth.
- D Water evaporates from the seas, rivers and living things.
- E Water vapour condenses to form small droplets of water.

Which one of the following shows the correct sequence of the water cycle?

- (1) D, B, A, C, E
- (2) D, A, B, E, C
- (3) D, A, E, B, C.
- (4) D, B, C, E, A

26. The diagram below shows a set-up in which water changes from one state to another.

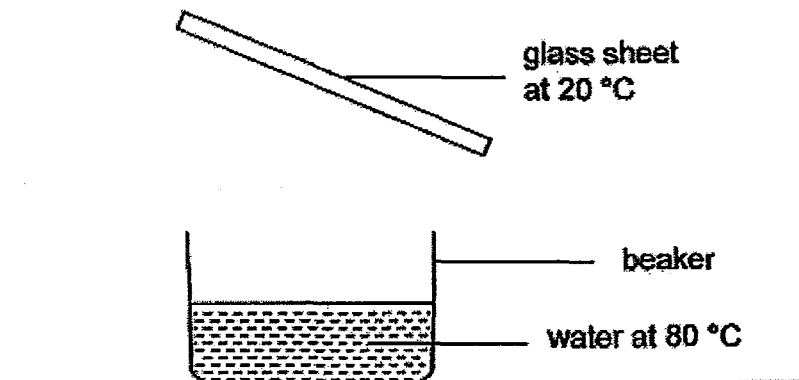

Which of the following will most likely result in an increase in the amount of water droplets formed on the glass sheet?

- A Add ice cubes into the beaker
- B Replace the glass sheet with a cooler glass sheet
- C Decrease the temperature of the water in the beaker

- (1) B only
- (2) A and C only
- (3) B and C only
- (4) A, B and C

27. When Jenny placed an object between the light source and the white screen, a shadow of the object was cast on the white screen as shown below.

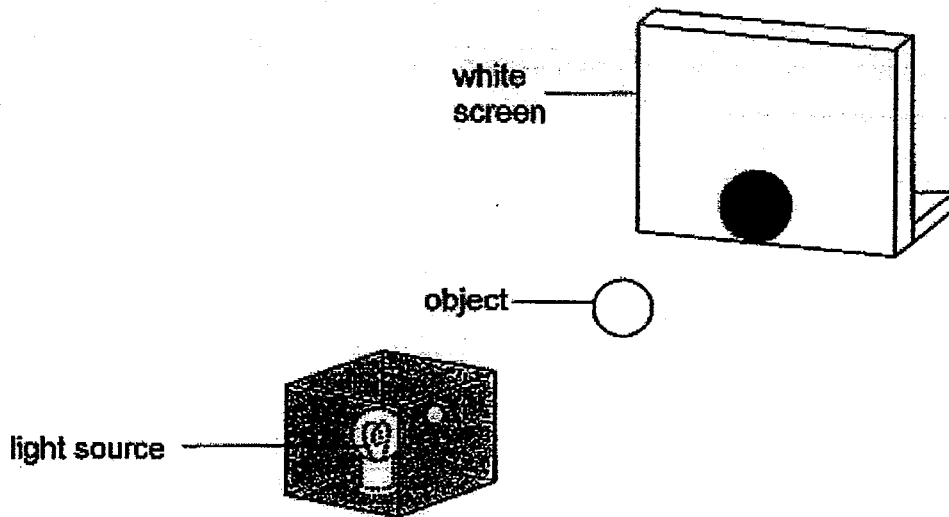



Which of the following changes should Jenny make to the set-up such that she could observe a smaller shadow of the object?

- A Use a brighter light source.
- B Move the screen nearer to the object.
- C Move the light source nearer to the object.
- D Move the light source further from the object.

- (1) A and C only
- (2) B and C only
- (3) B and D only
- (4) A, B and D only

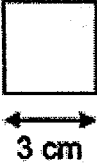
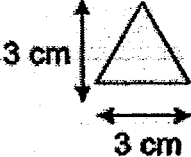

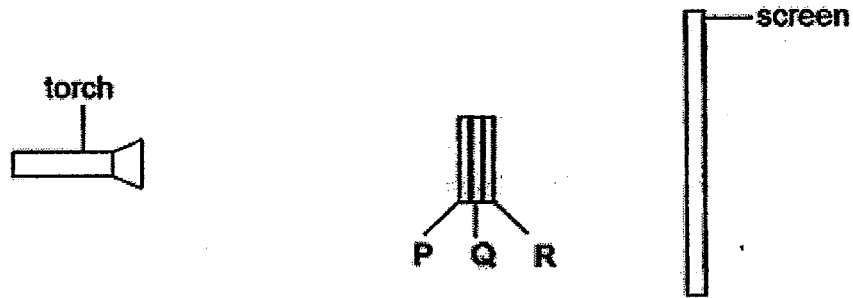

28. The diagrams below show three different objects.

Object P	Object Q	Object R
		
Translucent	Opaque	Transparent

Ali placed the 3 objects as shown below.



Which one of the following shadows will be cast on the screen when the torch is switched on?

- (1) 
- (2) 
- (3) 
- (4) 

29. Megan placed different number of identical spoons into cups A and B and then filled both cups with same amount of hot water at temperature  $80^{\circ}\text{C}$  as shown below.

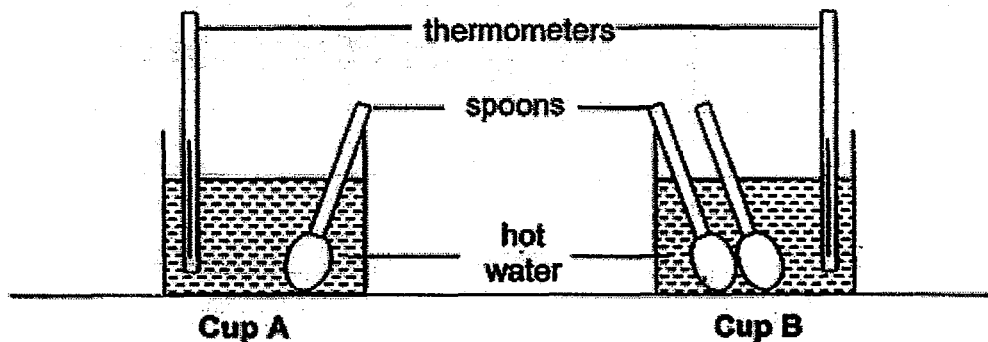

Megan observed that the temperature of water in one cup decreased more quickly than the other cup. Water in both cups eventually reach the same temperature after some time.

Which one of the following statements is correct?

- A The water in both cups gained heat from the surrounding air.
  - B Temperature of water in cup A decreased more quickly than in cup B.
  - C Two spoons conducted heat from the hot water to the surrounding air more quickly than one spoon.
  - D Water in cup B reached the same temperature as the surrounding in a shorter period of time than in cup A.
- 
- (1) A and B only
  - (2) B and C only
  - (3) C and D only
  - (4) A, C and D only

30. Sara filled two identical basins, A and B, with water of different temperatures. She then placed two identical flasks, X and Y, into basins A and B as shown in the diagram below.

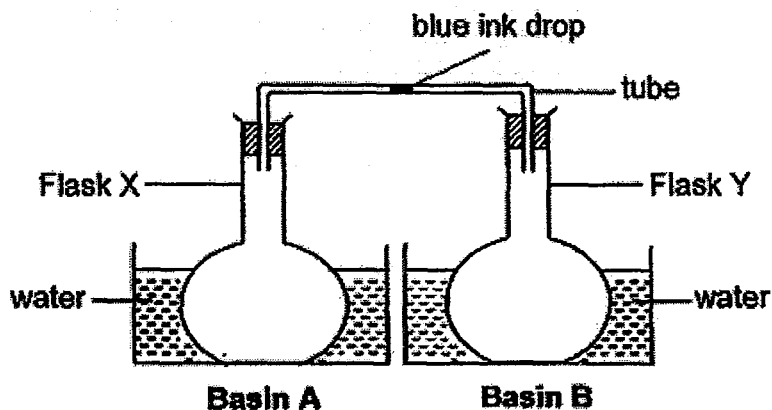

The set-up was left in a room of temperature 30°C.

After 10 minutes, Sara observed that the blue ink drop moved from the centre of the tube towards Flask Y. After another 10 minutes, the blue ink drop moved back to the centre of the tube.

Which of the following best represent the temperatures of water in basins A and B?

	Temperature of water in A (°C)		Temperature of water in B (°C)	
	at the start of the experiment	after 20 min	at the start of the experiment	after 20 min
(1)	70	30	50	30
(2)	50	30	70	30
(3)	50	30	70	50
(4)	70	50	50	30

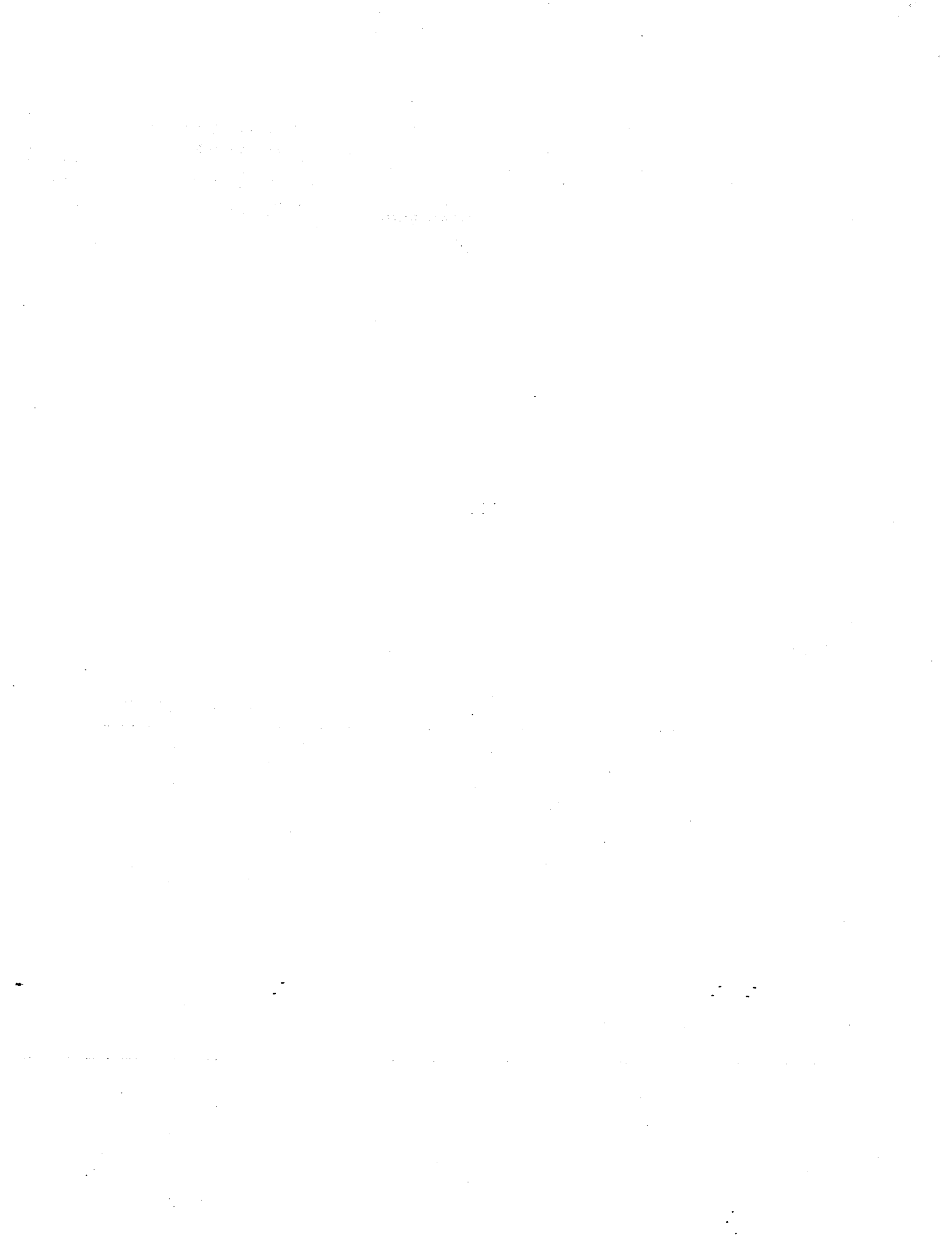

Name : \_\_\_\_\_ Index No : \_\_\_\_\_ Class : P5 , \_

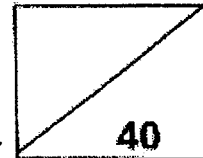

**SECTION B (40 marks)**

For questions 31 to 44, write your answers clearly in the spaces provided.

The number of marks available is shown in the brackets [ ] at the end of each question or part question.

31. Sherri wanted to find out if the roots of plants absorb water. She set up the experiment shown below, using the same type of plant.

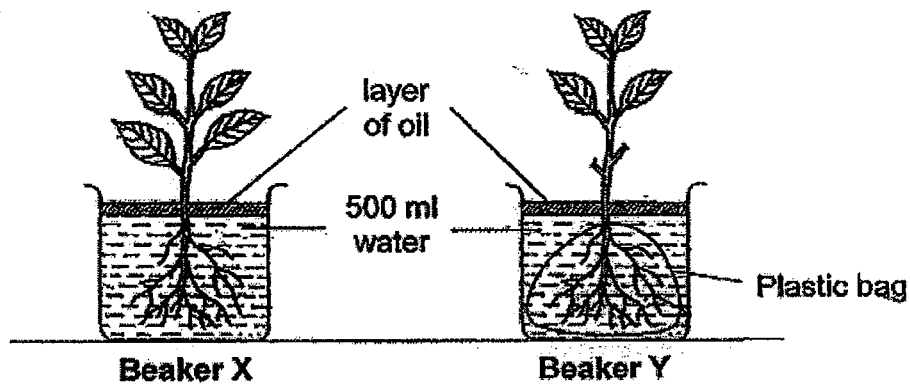

Sherri left the two beakers, X and Y, near the window for one day.

- (a) What observations should Sherri make in order to conclude that roots absorb water? [1]

---

---

- (b) Sherri's friend commented that the test was not fair. What change should Sherri make in order to ensure a fair test? [1]

---

---

- (c) Why did Sherri place a layer of oil on top of the water? [1]

---

---

Score	3
-------	---

32. The diagrams below show the life cycles of two animals.

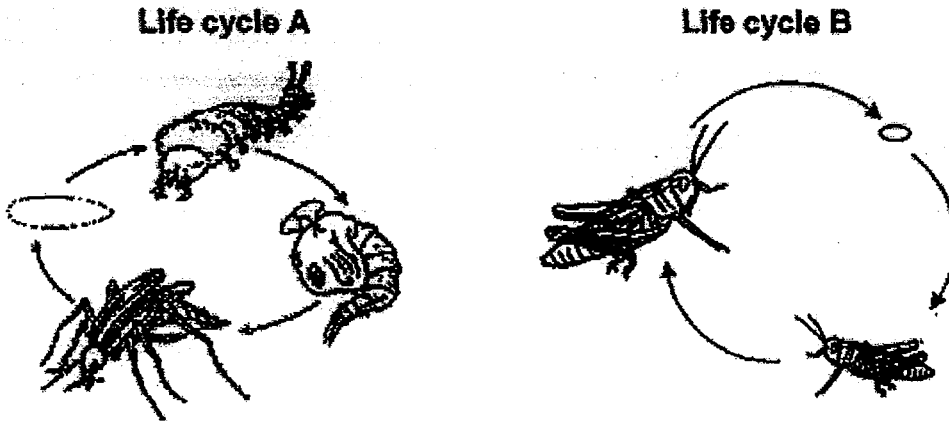

(a) State one difference between the two life cycles. [1]

---



---

(b) State one similarity between the two life cycles. [1]

---



---

The table below shows how some animals are classified based on similarity in their life cycles.

Characteristic	
P	Q
Housefly Mealworm beetle	Chicken Cockroach

(c) Suggest a possible heading for Group P. [1]

---

Score	3
-------	---



33. Joe conducted an experiment on the germination of seeds as shown below.

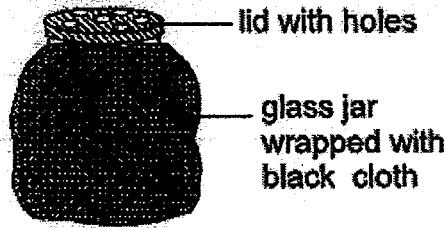

Jar P

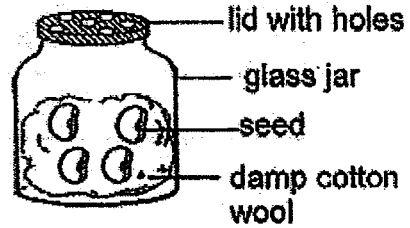

Jar Q

Joe placed the same number of seeds from the same plant in jars P and Q, lined with an equal amount of damp cotton wool. Only jar P was wrapped with a piece of black cloth. He left both jars near the window for a few days.

- (a) What is the purpose of the holes on the lid of each jar? [1]

---

---

- (b) Joe predicted that only the seeds in jar Q will germinate. Do you agree? Explain your answer. [1]

---

---

Score	$\frac{1}{2}$ 2
-------	-----------------

34. The diagram below shows a flower with both male and female reproductive parts.

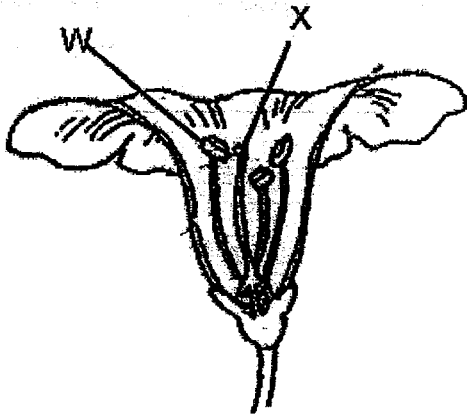

Flower of plant P

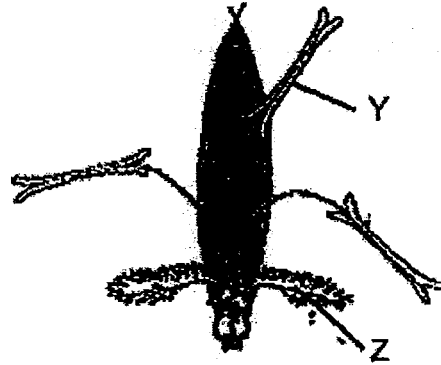

Flower of plant Q

- (a) Name the process that takes place after pollination has occurred. [1]

\_\_\_\_\_

- (b) Flowers from plant P and plant Q have different agents of pollination. Based on your observation of the flowers above, name the agent of pollination for each flower. State one characteristic of the flower to support your answer. (Do not compare size of the parts of the flowers.)

[2]

- (i) Agent of pollination for flower of plant P : \_\_\_\_\_

Characteristic: \_\_\_\_\_

- (ii) Agent of pollination for flower of plant Q : \_\_\_\_\_

Characteristic: \_\_\_\_\_

Score	3
-------	---

35. The diagrams below show the reproductive systems of a human and a plant.

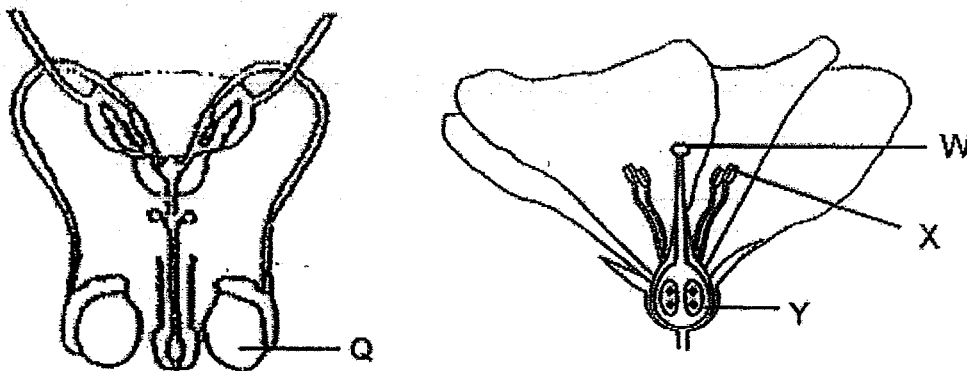

(a) Which part of the flower, W, X or Y, performs the same function as part Q? [1]

---

(b) The statements below describe the different stages leading to the development of a human foetus. [1]

- A The fertilised egg goes through cell division.
- B One sperm enters the egg successfully.
- C Many sperms are deposited in the vagina.
- D The nucleus of the sperm fuses with the nucleus of the egg.

Arrange the stages in the correct order by writing the letters in the boxes provided.



Score	2
-------	---

36. Jenna collected four identical fruits, P, Q, R and S, from plant X. She heated the fruits to different temperatures to find out how the ~~changes in temperature would affect the time taken for the fruit to split open~~ and the distance the seeds are dispersed.

She recorded her results in the table below.

	P	Q	R	S
Temperature of fruit (°C)	30	35	40	45
Time taken for fruit to split open (h)	2.5	2.0	1.0	0.5
Average distance seeds were dispersed (m)	2.0	2.7	4.0	6.2

- (a) At which temperature did the seeds travel the furthest when the fruit split open? [1]

- (b) Based on the data collected, what can Jenna conclude about the effect of temperature on the time taken for the fruit to split open? [1]

- (c) Seed dispersal is necessary to prevent overcrowding. Explain why plants do not grow well when there is overcrowding. [1]

Score	3
-------	---

37. The diagrams below show two different types of cells, X and Y.

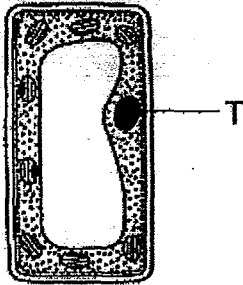

Cell X



Cell Y

(a) What is the function of part T? [1]



(b) Which cell, X or Y, is able to carry out photosynthesis? Give a reason for your answer. [1]



(c) Both cells, X and Y, were placed in a solution. After an hour, one of the cells swelled and burst but the other cell remain the same. Which cell, X or Y, swelled and burst? Give a reason for your answer. [1]



Score	3
-------	---

38. Paul conducted an experiment on four materials, W, X, Y and Z as shown below.

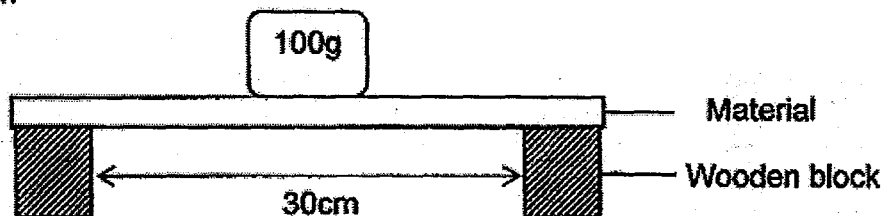

He placed each material on two wooden blocks and placed 100g weights, one at a time, on the centre of each material until the material break. He recorded his results in the table below.

Material	Number of 100g weights to cause the material to break
W	10
X	7
Y	6
Z	16

- (a) Based on the results above, which property of material was Paul trying to investigate? [1]

- (b) Put a tick (✓) in the appropriate box(es) to indicate the variables that Paul must keep the same to ensure a fair test. [1]

Variable	
Type of material	<input type="checkbox"/>
Thickness of material	<input type="checkbox"/>
Number of weights placed on the material	<input type="checkbox"/>
Distance between the two wooden blocks	<input type="checkbox"/>

- (c) Paul wanted to use one of the materials, W, X, Y or Z, to make a shelf to hold his books. Based on the results of his experiment, which material is most suitable to hold a large number of books? Explain your choice. [2]

Score	4
-------	---

39. Ahmad set up an experiment as shown below. Three identical flasks were filled with the same amount of liquids A, B and C. The flasks were placed in a basin of hot water at the same time.

After 3 minutes, the levels of liquid C rose the most, followed by liquid A and then liquid B, as shown in the diagram below.

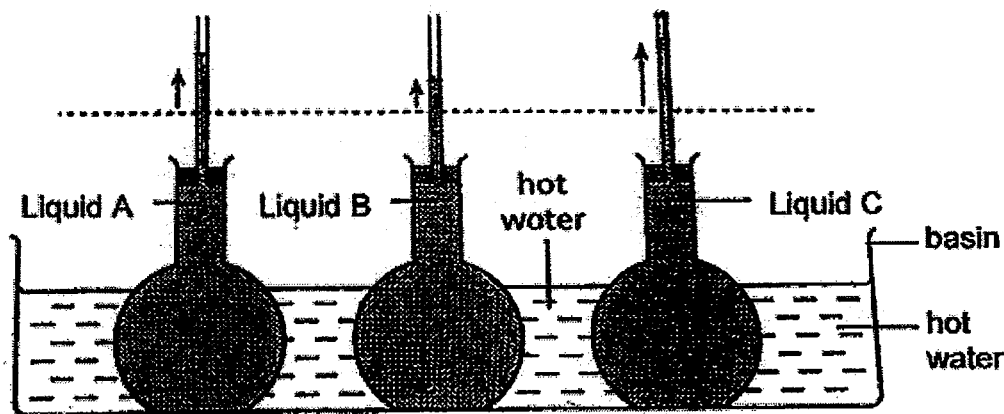

(a) Explain why the level of liquid in each flask rose. [2]

---



---



---

(b) The graph below shows the change in the volume of liquids A, B and C during the 3 minutes. Indicate the lines that represent the respective liquids by writing the letters A, B and C in the correct boxes. [1]

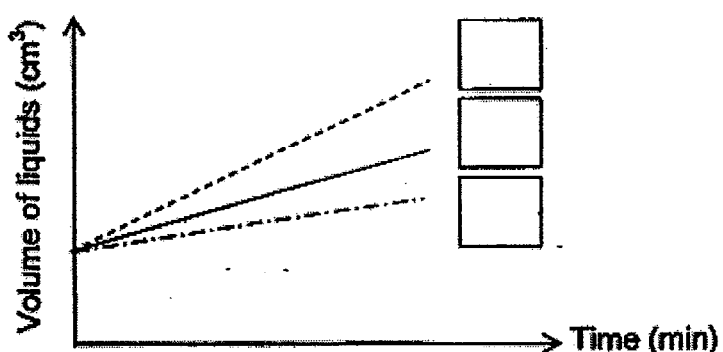

Score	3
-------	---

40. Sophia had two identical cups, X and Y. She poured hot water into one cup and cold water into another cup. She covered each cup with a lid and left both cups on the table for a short while.

She observed water droplets formed on different parts of the cups as shown in the diagrams below.

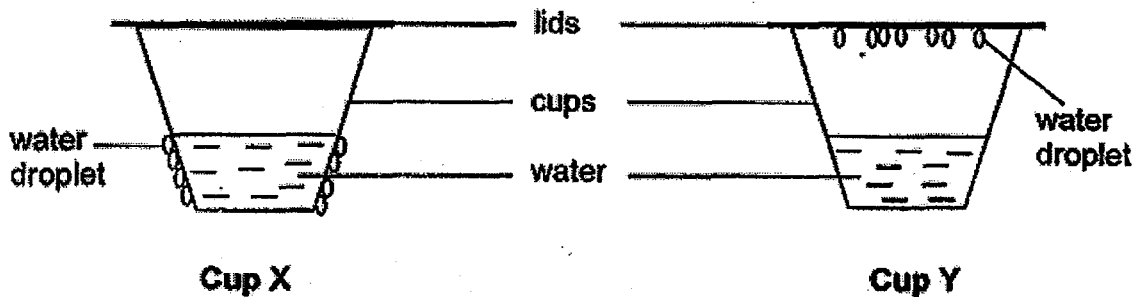

(a) Which cup, X or Y, contained hot water? Explain your answer. [2]

---



---



---

(b) Sophia poured same amount of water of a higher temperature than in part (a) into another identical cup, Z, and then covered with a lid.

Compare the amount of water droplets formed in cup Z with the cup in part (a). [1]

---

Score	3
-------	---



41. The table below shows the freezing points and boiling points of substances P and Q.

Substance	Freezing point ( $^{\circ}\text{C}$ )	Boiling point ( $^{\circ}\text{C}$ )
P	110	180
Q	44	280

- (a) What is the state of each of the substances, P and Q, at  $200^{\circ}\text{C}$ ? [2]

P: \_\_\_\_\_

Q: \_\_\_\_\_

- (b) Another substance, R, exists in solid state at  $50^{\circ}\text{C}$  and in liquid state at  $90^{\circ}\text{C}$ .

Arrange substances, P, Q and R, according to their melting points in ascending order. [1]

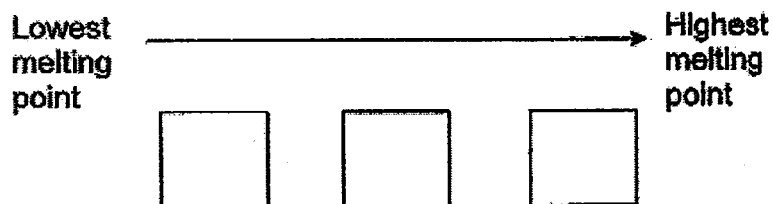

Score	3
-------	---

42. Sally wanted to find out how the amount of light reflected by each of the three materials, X, Y and Z is affected by the distance between the torch and the material. She carried out the experiment in a completely dark room using the set-up shown below.

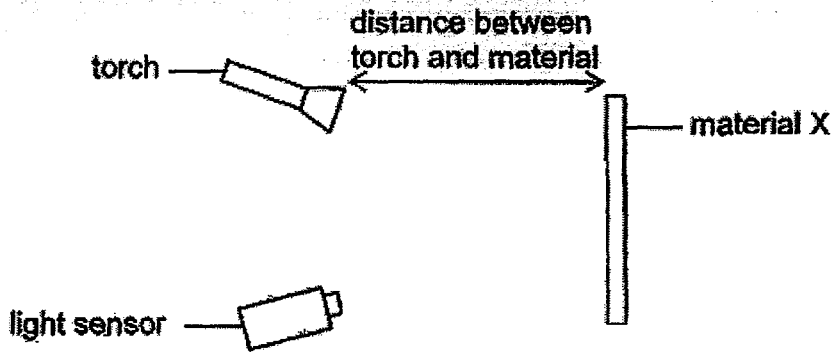

- (a) Draw light rays in the above diagram to show how the light sensor detects light reflected by material X when the torch is switched on. [1]

Sally recorded the amount of light reflected by material X using a light sensor. Then she repeated the experiment with materials Y and Z, one at a time. The graph below shows the results of Sally's experiment.

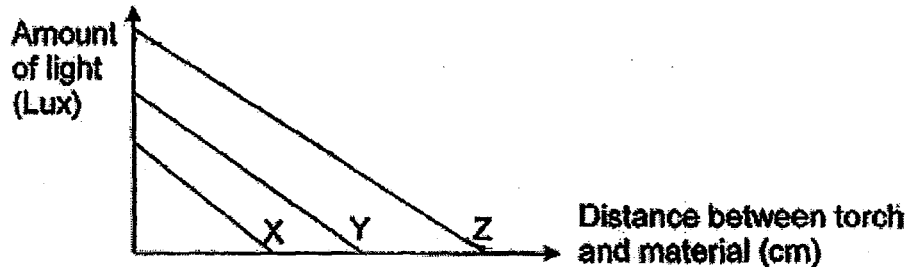

- (b) What is the relationship between the amount of light reflected by the materials and the distance between the torch and the material? [1]

---



---

- (c) Based on Sally's results, which material, X, Y or Z should she use to make safety jackets for cyclists to wear at night? Give a reason for your answer. [1]

---



---

Score	3
-------	---

43. Jenny prepared the set-up as shown below.

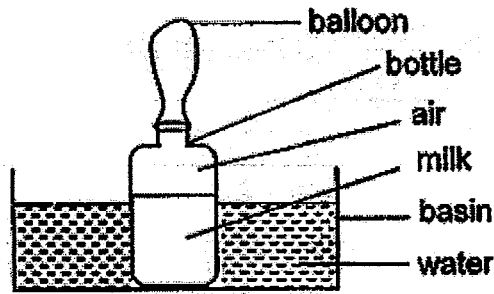

Jenny observed that the balloon became bigger in size after 5 minutes.

- (a) What happened to the temperature of water in the basin after 5 minutes? [1]

---

---

- (b) Fill in the blanks with "heat gain" or "heat loss" for the milk in the bottle and the water in the basin during the 5 minutes. [1]

Milk : \_\_\_\_\_

Water : \_\_\_\_\_

Score	2
-------	---

44. Ravi wrapped 3 identical beakers with different materials, A, B and C. He then filled each beaker with 200 ml of water at 70°C and covered them with identical lids as shown in the diagram below

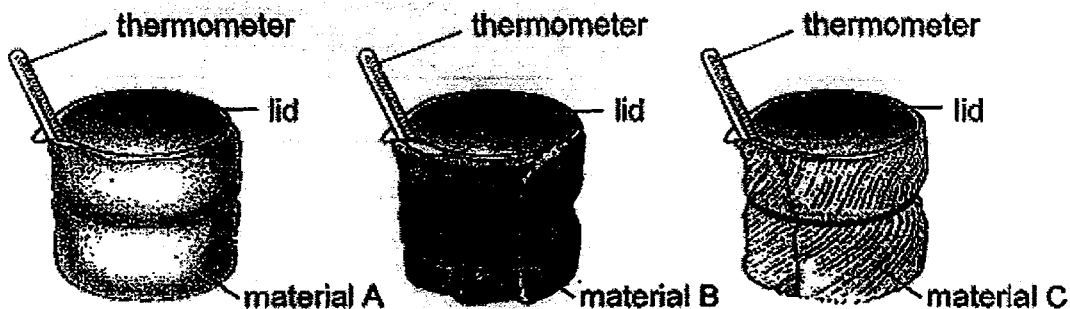

Ravi recorded the temperature of the thermometer over a period of time. His results are shown in the graph below.

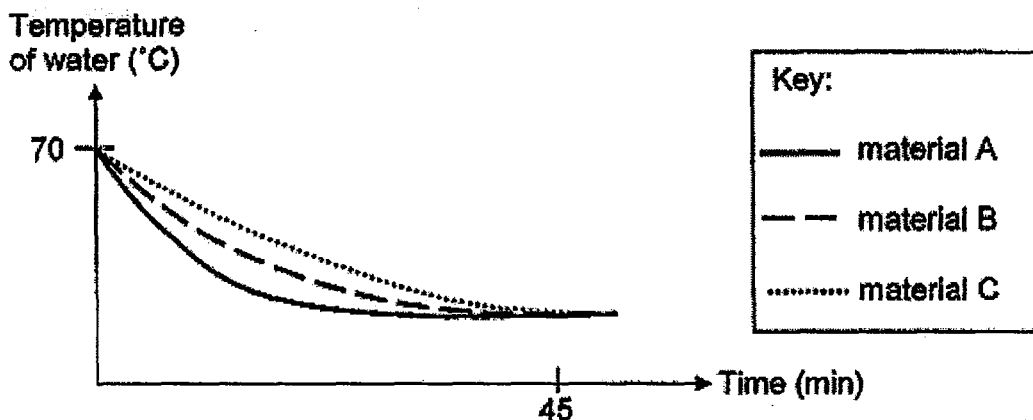

- (a) Based on Ravi's results, which material, A, B or C, should he use to make a blanket to keep himself warm? Give a reason for your answer. [2]

---



---



---

- (b) Ravi observed that the water in all the three beakers reached the same temperature after 45 minutes. Explain his observation. [1]

---



---

- END OF PAPER -

**EXAM PAPER 2015**

**LEVEL : PRIMARY 5**

**SCHOOL : RAFFLES GIRLS' PRIMARY SCHOOL**

**SUBJECT : SCIENCE**

**TERM : SA1**

Q 1	Q 2	Q 3	Q 4	Q 5	Q 6	Q 7	Q 8	Q 9	Q 10
2	4	1	4	1	4	1	2	3	1
Q 11	Q 12	Q 13	Q 14	Q 15	Q 16	Q 17	Q 18	Q 19	Q 20
1	3	1	3	1	2	3	2	1	1
Q 21	Q 22	Q 23	Q 24	Q 25	Q 26	Q 27	Q 28	Q 29	Q 30
1	2	4	4	3	1	3	3	3	1

Q31a. Water level in beaker X decreased but water level in beaker Y remained the same.

Q31b. Make both plants have the same number of leaves.

Q31c. To ensure that no water would evaporate and all the water that is left is because of the roots taking in water.

Q32a. Life cycle A has 4 stages while life cycle B has 3 stages.

Q32b. Both life cycles have an egg stage.

Q32c. Young does not look like the adult.

Q33a. All seeds need oxygen from the air for germination so the holes is to let air enter the jar.

Q33b. No. Both Jars P and Q had all the needs for seeds to germinate. Both jars had oxygen, water and warmth all need for germination.

Q34a. Fertilisation

Q34bi) Agent of pollination for flower of plant P: Insect

Q34bi) Characteristic: The stigma's of the flower are all inside the plant, so when an insect goes to the plant, the pollen grains will land on the stigma.

Q34bii) Agent of pollination of flower of plant Q: Wind

Q34bii) Characteristic : The stigma's of the flower are sticking out, so when the wind blows, the pollen grains will land on the stigma.

Q35a. X

Q35b. C → B → D → A

Q36a. 45°C

Q36b. The higher the temperature, the lesser the time is taken for the fruit to split open.

Q36c. Overcrowding causes the plants to compete for space, water, mineral salts and sunlight.

Q37a. To control all cellular activities done by each cell.

Q37b. Cell X. It has chloroplast which has chlorophyll which traps sunlight for photosynthesis.

Q37c. Cell Y. It does not has a cell wall.

Q38a. Strength

Q38b. Variable : - Thickness of material, Distance between the two wooden blocks.

Q38c. Z It managed to take the most amount of weights before it broke, which means it has to be the strongest material out of the rest.

Q39a. The hot water lost heat to the liquids and when things get hot and expand. Hence when the liquids expand the level of the liquid in each flask rose.

Q39b. SEE PICTURE

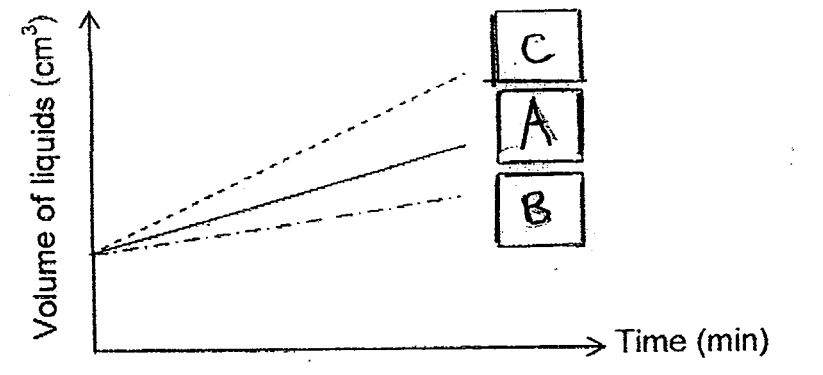

Q40a. Cup Y contained hot water. Water droplets are found on the inner side of cup Y. The hot water in cup Y evaporated to form water vapour which then condenses on the cooler lid to form water droplets.

Q40b. There will be more water droplets found on the lid of Z than Y.

Q 41a. P: Gas Q: Liquid

Q41b. Q R P

Q42a. SEE PICTURE

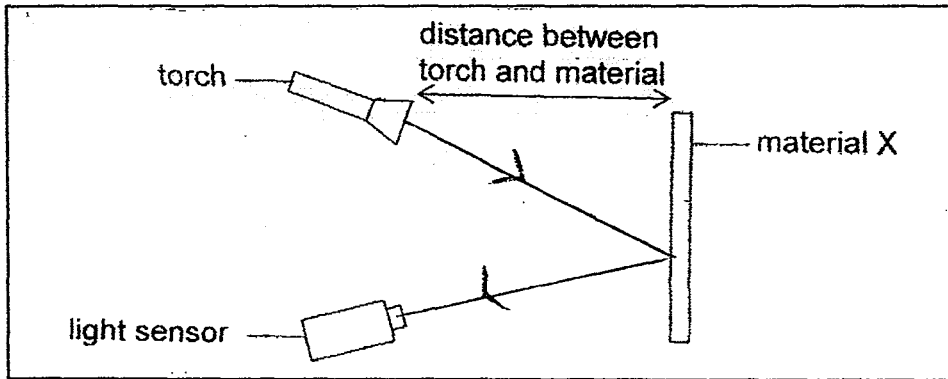

Q42b. The shorter the distance between the torch and the material the more the amount of light reflected by the material.

Q42c. Z. It reflects light from the greatest distance.

Q43a. The temperature of the water in the basin will decrease.

Q43b. Milk: heat gain

Q43b. Water : heat loss

Q44a. Temperature of water in beaker wrapped in C dropped the slowest. With blanket of C, Ravi will lose heat slowest, hence keeping him the warmest.

Q44b. There is no more heat transfer between the water in beakers and the surroundings.

**THE END**

