

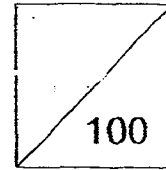

**HENRY PARK PRIMARY SCHOOL
2015 SEMESTRAL EXAMINATION 2
SCIENCE
PRIMARY 4**



Duration of Paper: 1 h 45 min

Name: _____ ()

Parent's Signature: _____

Class: Primary 4 _____

Part A: Multiple-Choice Questions (30 X 2 = 60 marks)

For each question from 1 to 30, four options are given. One of them is the correct answer. Make your choice (1, 2, 3 or 4). Shade the correct oval (1, 2, 3 or 4) on the Optical Answer Sheet.

1. A snail hides itself in its shell when touched.

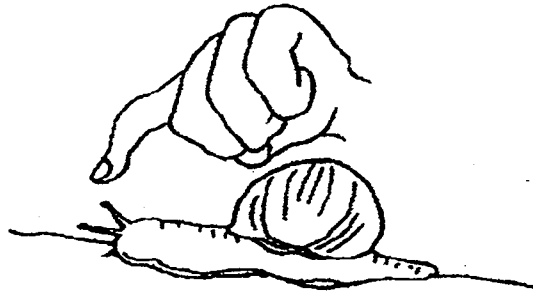

This shows that the snail is a living thing because it can _____.

- (1) die
- (2) grow
- (3) breathe
- (4) respond

()



2. Which one of the animals shown below is **NOT** an insect?

(1)

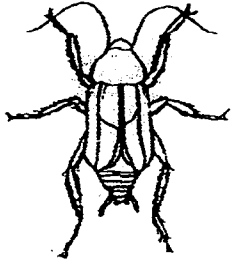

(2)



(3)

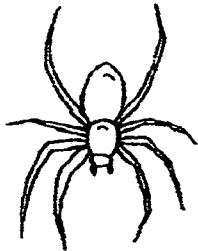

(4)

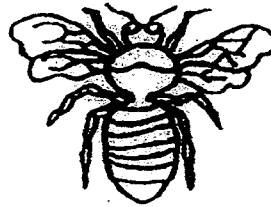

()

3. Which of the following objects is **NOT** made of waterproof material?

(1)

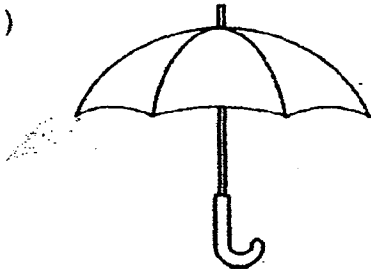

plastic umbrella

(2)

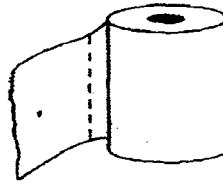

toilet paper

(3)

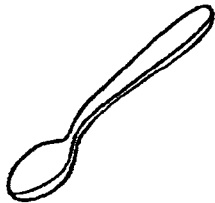

metal spoon

(4)

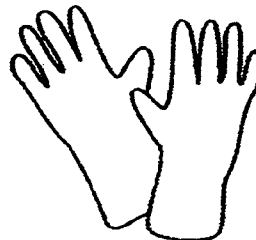

rubber gloves

()



4. Which one of the following objects can be bent easily without breaking?

(1)

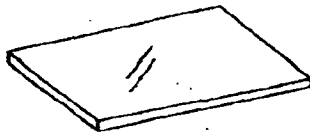

A sheet of glass

(2)

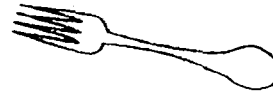

plastic fork

(3)



towel

(4)

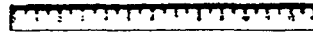

wooden ruler

()

5. Which animal has a pupa as a stage in its life cycle?

- (1) frog
- (2) butterfly
- (3) chicken
- (4) cockroach

()

6. Matter is anything that has mass and occupies space.
Which one of the following is **NOT** matter?

- (1) air
- (2) water
- (3) sand
- (4) shadow

()

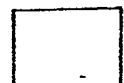

7 Which part, (1), (2), (3) or (4), takes in water for the plant?

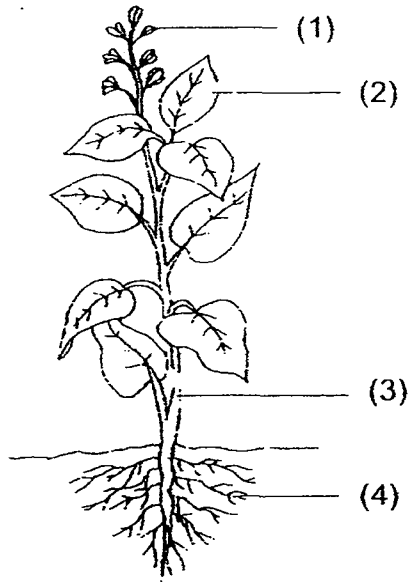

()

8. In which part of the digestive system is food absorbed into the blood?

- (1) gullet
- (2) mouth
- (3) small intestine
- (4) large intestine

()

9. Object A was attracted to a magnet, as shown below.

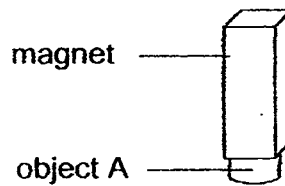

Object A is made of _____.

- (1) iron
- (2) glass
- (3) plastic
- (4) rubber

()



10. The set-up below shows light shining on a rubber ball.

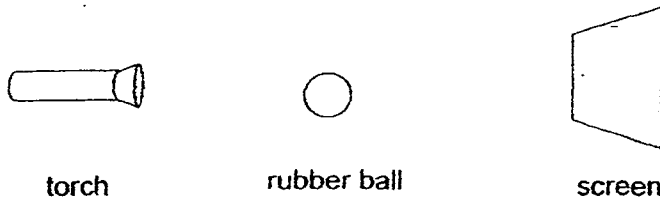

Which one of the following would likely be seen on the screen?

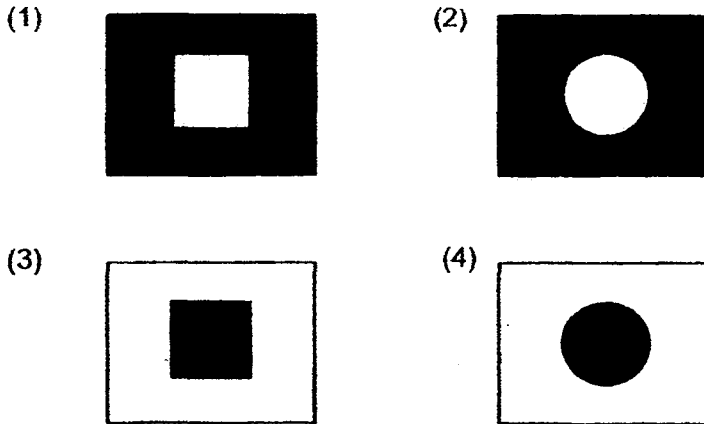

()

11. The diagram below shows a wooden pole placed in the middle of a square board. 4 bulbs (A, B, C and D) are placed at each corner of the board.

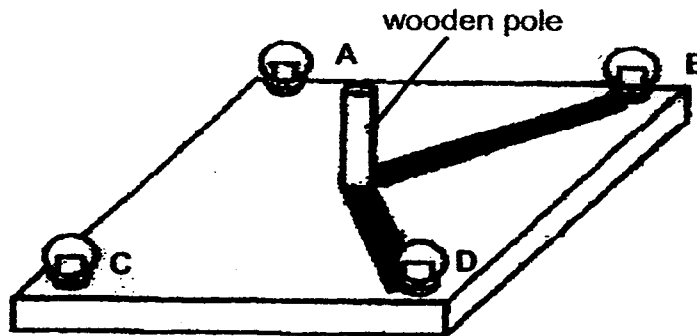

Which of the bulbs have to be switched on at the same time so that the shadows of the wooden pole are formed as shown in the diagram above?

- (1) A and B only
- (2) A and C only
- (3) B and C only
- (4) B and D only

()



12. The diagram below shows an experimental set-up.

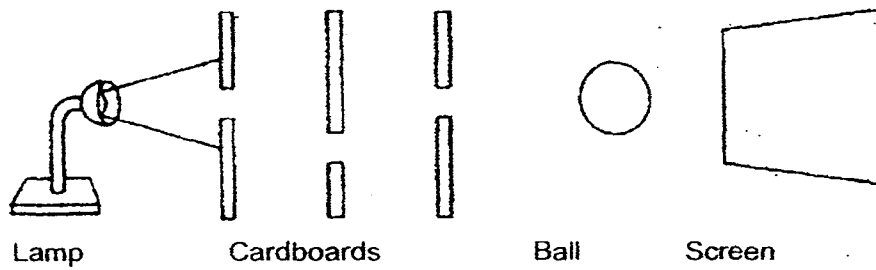

4 students, Ann, Ben, Chris and Dawn, each makes a statement based on the set-up.

The shadow of the ball will be on the screen.



Ann

The shadow of the cardboard will be on the screen.



Ben

There will be a bright patch of light on the screen.



Chris

There will be no bright patch of light or shadow on the screen.



Dawn

Whose statement is correct?

- (1) Ann
- (2) Ben
- (3) Chris
- (4) Dawn

()

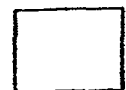

13. Jerry placed a pencil between a torch and a screen as shown below.

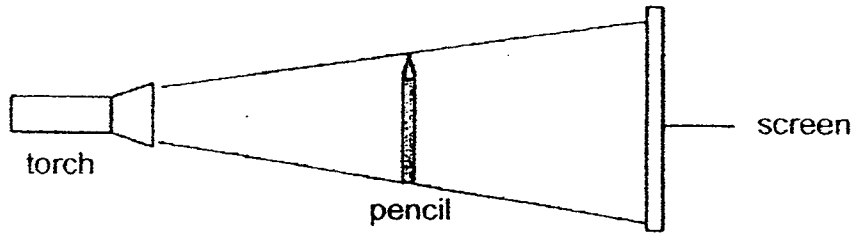

If Jerry wants to get a bigger shadow, what should he do?

- A Move the pencil nearer to the torch.
- B Move the pencil nearer to the screen.
- C Move the screen further from the pencil.



- (1) A only
- (2) B only
- (3) A and C only
- (4) B and C only

()

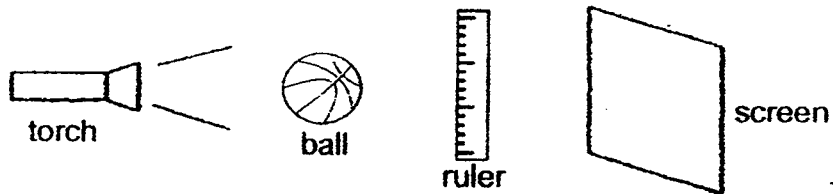
14. Ahmad shone a torch on a rubber ball and a wooden ruler which are placed in a straight line as shown below.

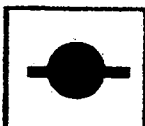

Which one of the following shadows would he observe?

- (1) 
- (2) 
- (3) 
- (4) 

()



15. Jimmy is walking under a street lamp at night as shown below.

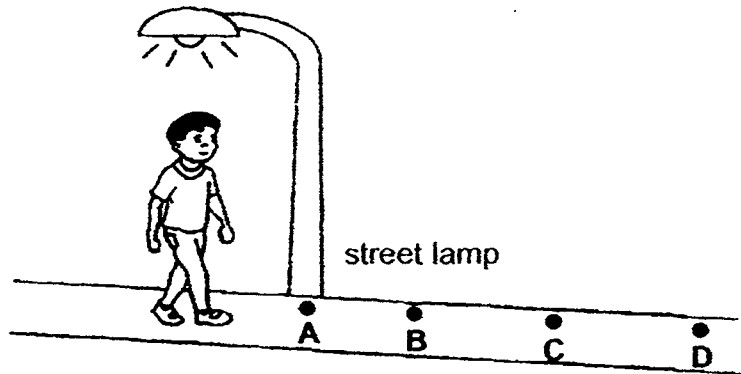

At which point will his shadow be the longest?

- (1) A
- (2) B
- (3) C
- (4) D

()

16. Raju carried out the experiment shown below in a dark room.

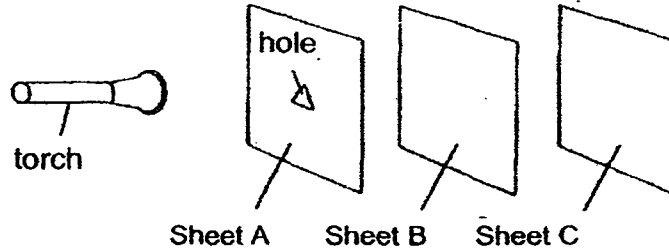

Sheets A, B and C are arranged in a straight line. When the torch is switched on, a bright triangular patch of light is seen on Sheet C only.

Which one of the following correctly describes the properties of the materials that sheets A, B and C are made of?

	Allows light to pass through	Does not allow light to pass through
(1)	A	B and C
(2)	B	A and C
(3)	A and B	C
(4)	A and C	B

()

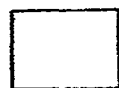

17. Which one of the following diagrams shows correctly the path of light that makes it possible for Hana to see the plant?

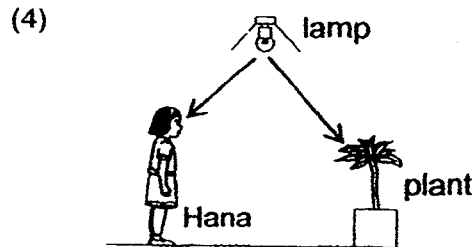
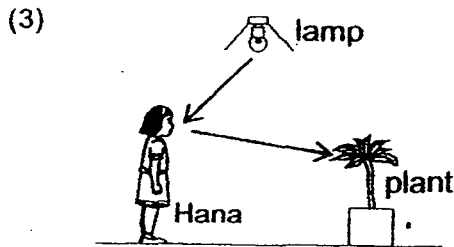
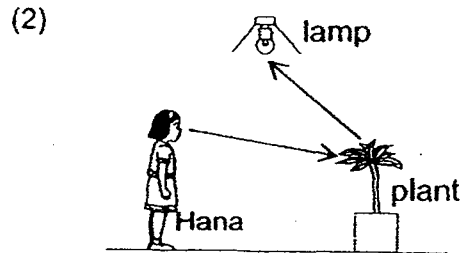
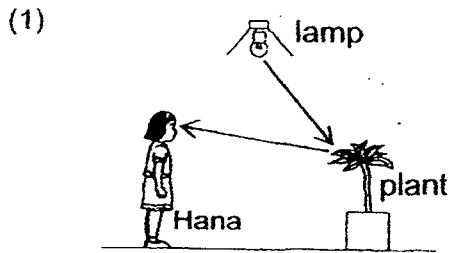

()

18. The diagram below shows a plant.

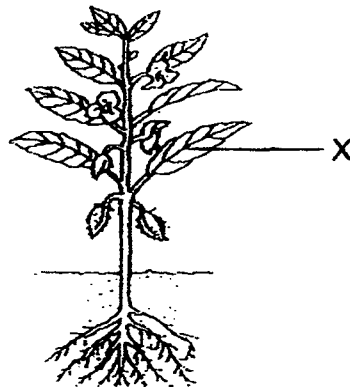

What will happen if Part X of the plant is removed?

- A The plant cannot make food.
- B The plant cannot remain upright.
- C Water cannot be transported to the plant.

- (1) A only
- (2) C only
- (3) A and C only
- (4) B and C only

()



19. Lisa was walking in a park and she saw some fungi growing on a dead log as shown below.

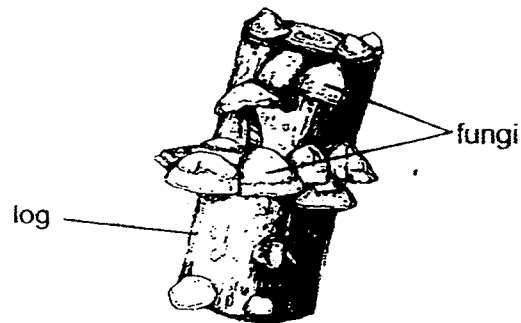

Which of the following statements about the fungi is correct?

- (1) The fungi reproduce by seeds.
- (2) The fungi make food for the log.
- (3) The fungi depend on the dead log for food.
- (4) The fungi are plants that grow on dead logs.

()

20. Claire placed a white rose into a beaker of red - coloured water.

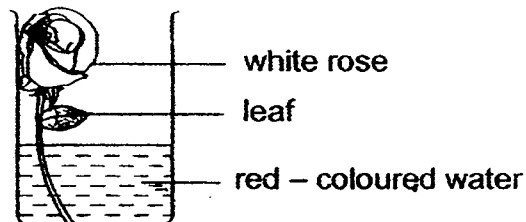

After a few hours, she noticed that some parts of the rose and the leaf turned red.

Based on the above experiment, which of the following statements are correct?

- A Water is taken in by the leaf.
- B Water is transported to the leaf.
- C Water is transported to the rose.
- D Water is carried through the stem.

- (1) A and C only
- (2) B and D only
- (3) B, C and D only
- (4) A, B, C and D

()

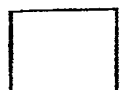

21. The diagram below shows the digestive system of a human body.

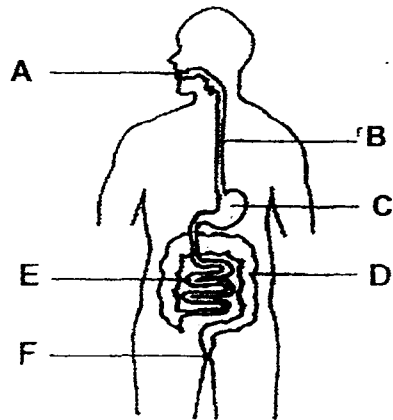

Which parts of the above system produce digestive juices to digest the food we eat?

- (1) A, B and F only
- (2) A, C and E only
- (3) C, D and E only
- (4) B, C and F only

()

22. Study the groups below.

Which one of the following groups consists of only matter?

- (1) glue, paint, pebble
- (2) music, light, paper
- (3) sugar, shadow, soap
- (4) syrup, shoe, thunder

()



23. A ball of plasticine was placed into a beaker of water. The total volume of water and ball of plasticine was 300 cm^3 as shown below.

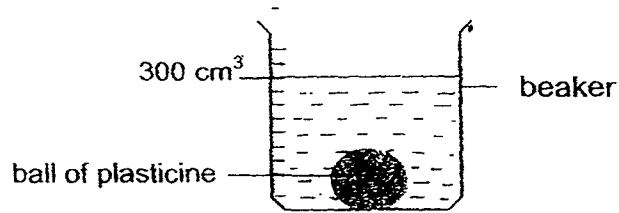

The plasticine was removed from the beaker of water and cut into two pieces. They were dropped into the same beaker of water again as shown below.

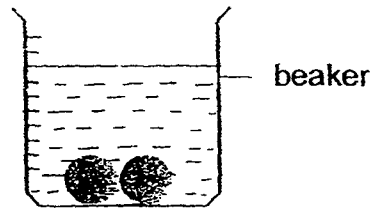

What would the total volume of water and plasticine be now?

- (1) 150 cm^3
- (2) 200 cm^3
- (3) 300 cm^3
- (4) 600 cm^3

()



24. Two objects, A and B, are placed on a balance as shown below. They are equally balanced.

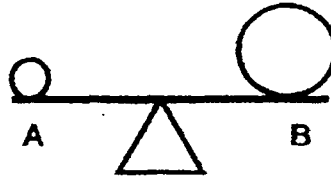

Which of the following statements about the two objects are correct?

- A A has a smaller mass than B.
 - B A and B have the same mass.
 - C B has a greater volume than A.
 - D A and B have the same volume.
- (1) A and C only
 (2) B and C only
 (3) A and D only
 (4) B and D only

()

25. Susan had 2 similar glasses of water at different temperatures as shown below.

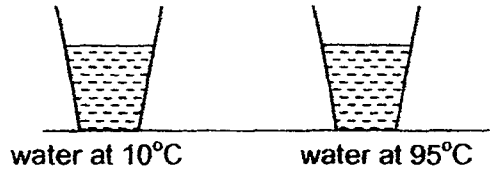

She poured the two glasses of water into a basin in a room at 30°C and mixed the water well.



Which one of the following correctly shows the temperature of water in the basin immediately and 6 hours later?

Temperature of water in the basin (°C)

	Immediately	6 hours later
(1)	105	30
(2)	95	30
(3)	50	30
(4)	50	20

()

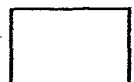

26. An iron strip with four similar drops of wax, A, B, C and D, was heated at one end as shown in the diagram below.

Wax A melted and dripped off first, followed by B, C and D.

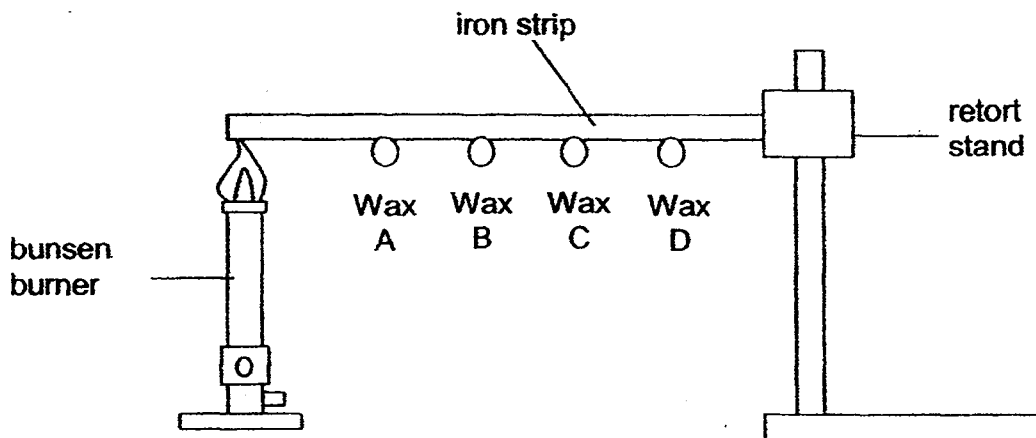

The strip was bent into a ring and heated with another four similar drops of wax as shown below.

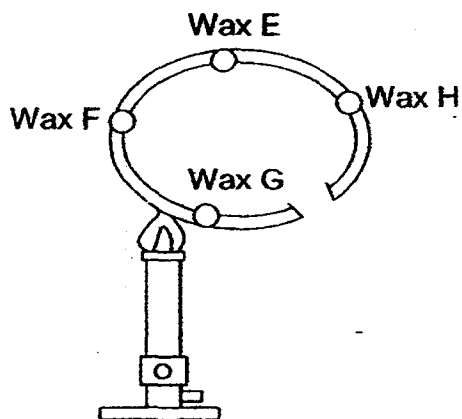

In which order would the wax melt and drip off?

- (1) E, F, G, H
- (2) G, E, F, H
- (3) G, F, E, H
- (4) H, E, G, F

()



27. Teresa wrapped the flask with a piece of wet cloth at 80°C.

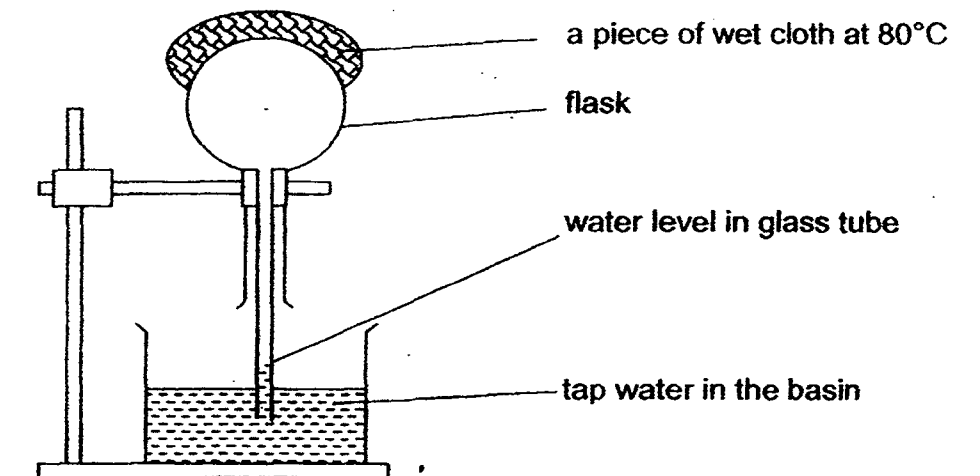

Which of the following is/are possible observation(s) of the set-up 2 minutes after the cloth was placed on the flask?

- A Water level in the glass tube dropped.
- B Water level in the glass tube rose.
- C Small bubbles escaped through the glass tube into the basin of tap water.

- (1) A only
- (2) B only
- (3) A and C only
- (4) B and C only

()



28. Terence conducted an experiment as shown below.

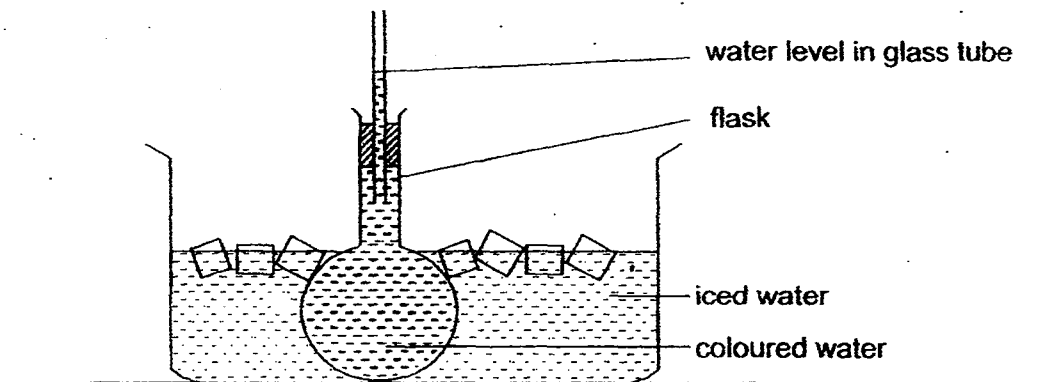

Which of the following correctly describe what Terence would observe 2 minutes after placing the flask into the iced water and its explanation?

	Observation	Explanation
(1)	Water level in the glass tube fell.	Water in the flask lost heat and contracted.
(2)	Water level in the glass tube fell.	Water in the flask gained heat and expanded.
(3)	Water level in the glass tube rose.	Water in the flask gained heat and expanded.
(4)	Water level in the glass tube rose.	Water in the flask lost heat and contracted.

()

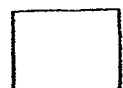

29. David carried out an experiment to find out which material (A, B, C or D) absorbs the most water. He set up his experiment as shown below.

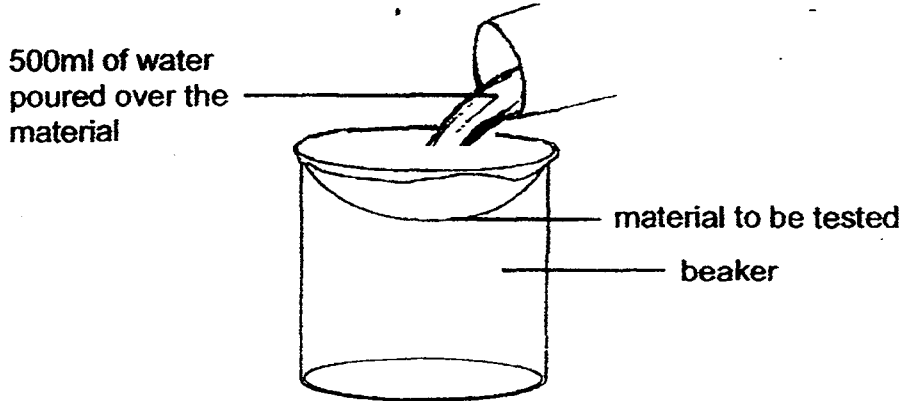

The diagrams below show his results.

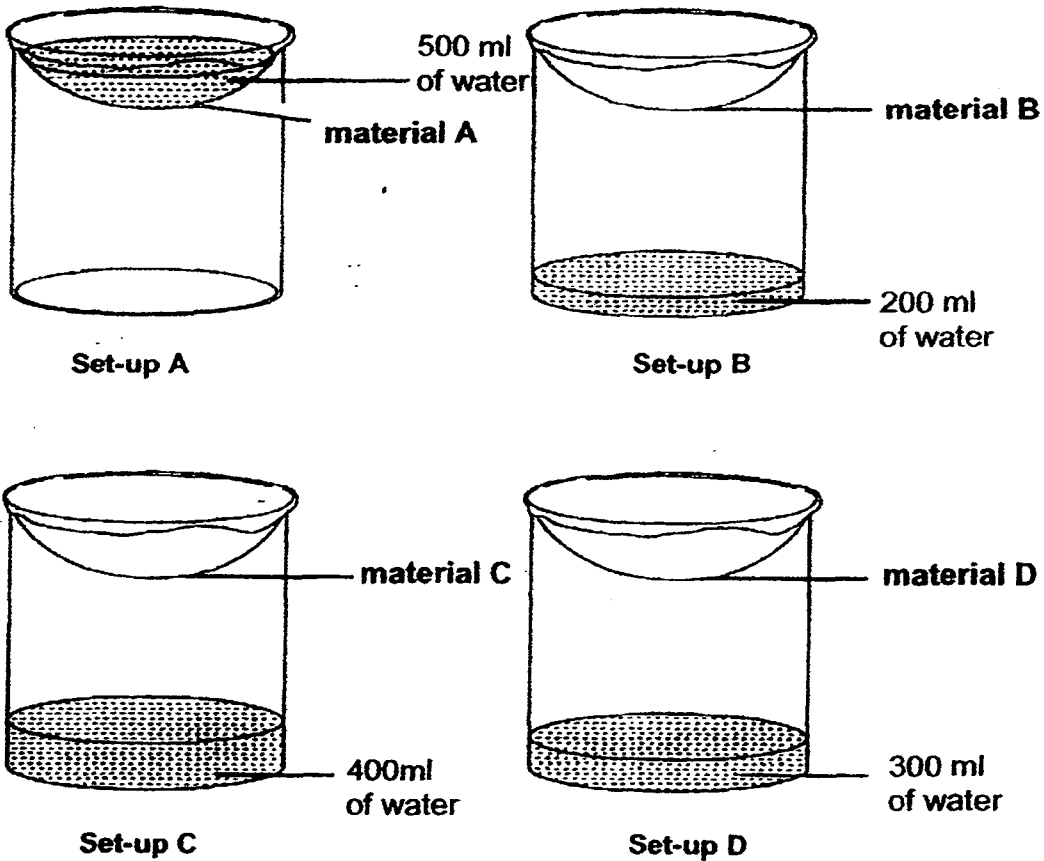

A bath towel is used to dry yourself after a shower.

Which is the most suitable material to make a bath towel?

- (1) Material A
- (2) Material B
- (3) Material C
- (4) Material D



30. Fazal hung 4 objects, P, Q, R and S, on a stand as shown below.

Each object came to rest at different positions. He recorded his findings in the table below.

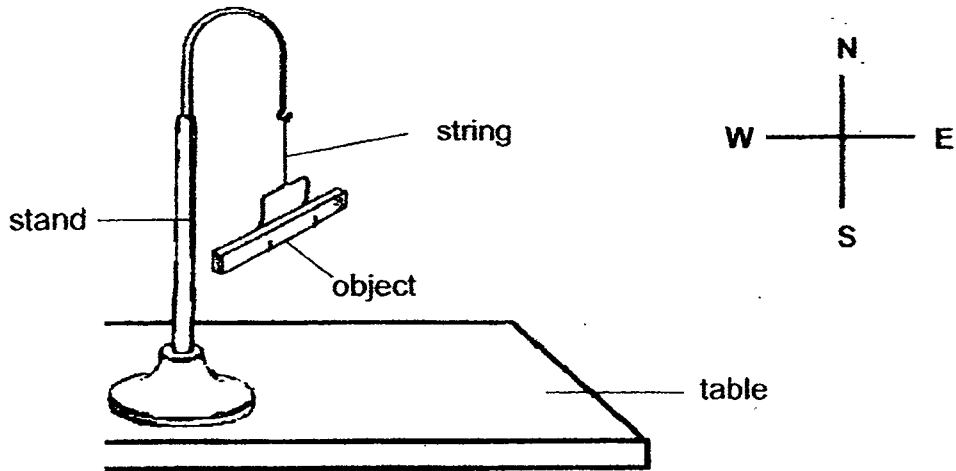

Object	Resting position
P	
Q	
R	
S	

Based on the table, which of the following is a magnet?

- (1) Object P
- (2) Object Q
- (3) Object R
- (4) Object S

()

End of Booklet A



HENRY PARK PRIMARY SCHOOL
2015 SEMESTRAL EXAMINATION 2
SCIENCE
PRIMARY 4

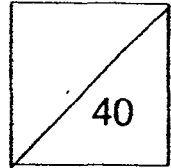

Name: _____ ()

Class: Primary 4 _____

Part B Open - Ended Questions (40 marks)

Write your answers to questions 31 to 44 in the spaces given.

31. The diagram below shows the stages in the life cycle of a plant.

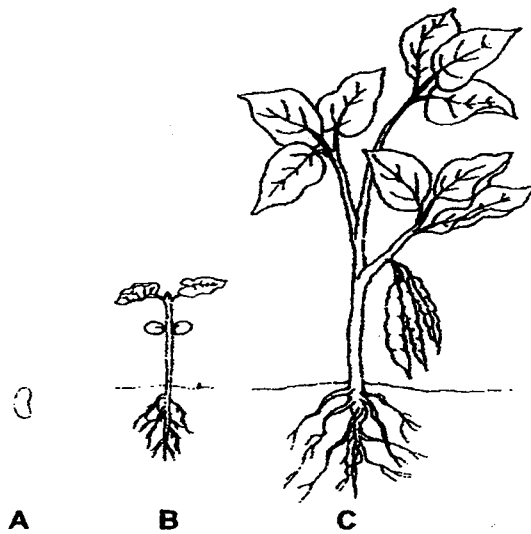

egg seed adult plant young plant

Name the stages A and C in the life cycle of the plant.

[2m]

A: _____

C: _____

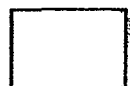

32. Classify the following into matter and non-matter in the table below.

air	soil	light
-----	------	-------

[2m]

Matter	Non - Matter

33. Two magnets are placed together as shown below.

The north pole of magnet 1 is labelled N.

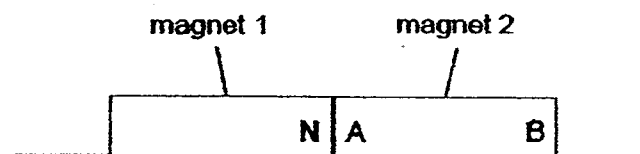

Name the poles labelled A and B on magnet 2.

[2m]

A: _____

B: _____



34. Jane used an instrument to measure the temperature of water in a beaker.

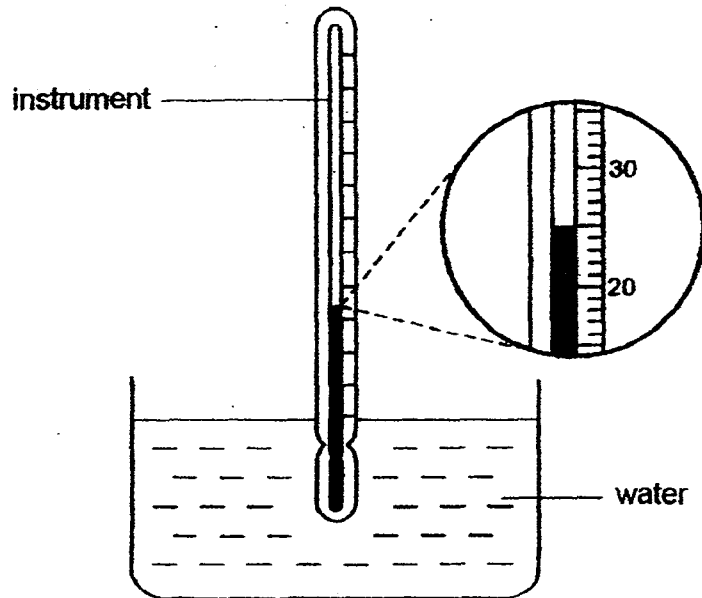

(a) What is the instrument called? _____ [2m]

(b) What is the temperature of the water in the beaker? _____ °C

35. James placed a metal rod and a plastic rod into a tank of boiling water as shown below.

Equal amounts of wax were put on both rods.

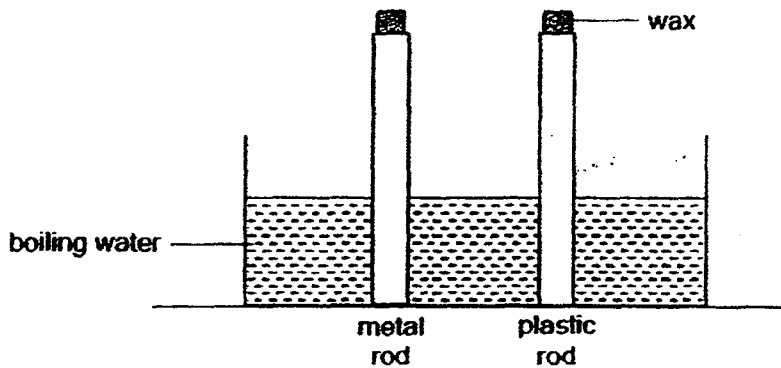

What would he observe and why? [2m]

The wax on the plastic rod melted _____ than the wax on the metal rod, as plastic is a _____ conductor of heat than metal.



36. Carol set up an experiment as shown below.

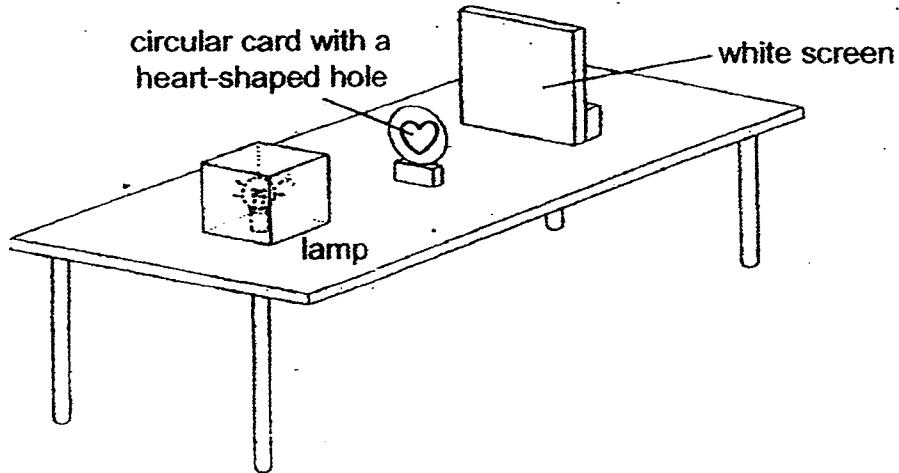

A shadow was formed on the screen.

(a) Explain why the shadow was formed.

[1m]

(b) What will be the shadow formed on the screen?

Put a tick (✓) in the correct box below.

[1m]

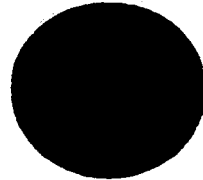
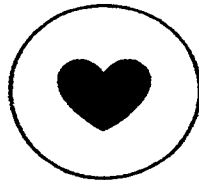

(c) As the circular card is moved away from the lamp, state 2 changes in the shadow Carol would see on the screen.

[2m]

(i) _____

(ii) _____



37. The diagram below shows some objects.

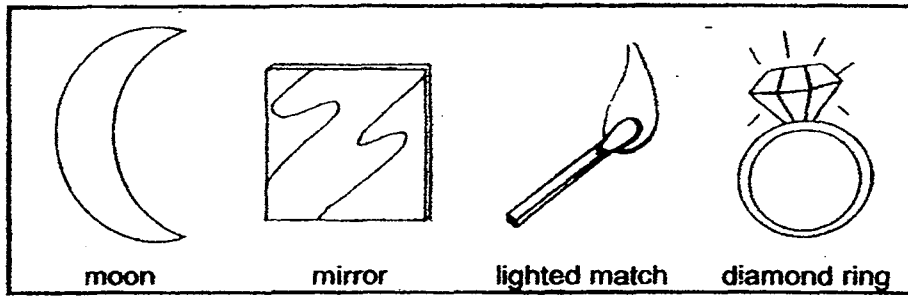

(a) Classify the objects by filling in their names in the correct boxes of the classification chart below.

[2m]

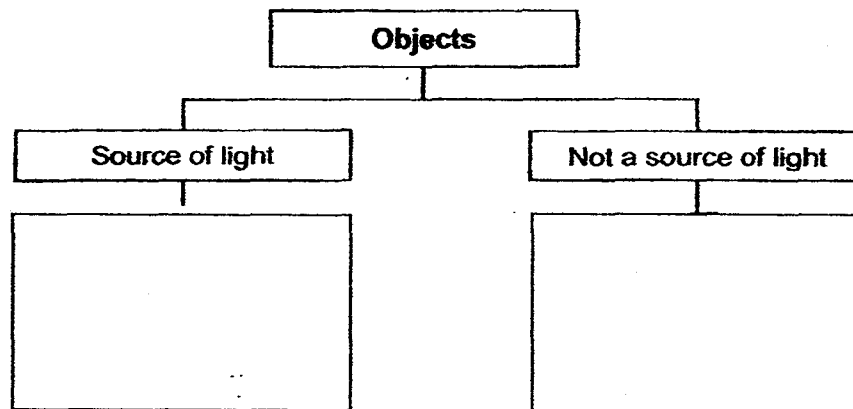

The diagram below shows the angler fish which lives in the deep ocean where it is very dark.

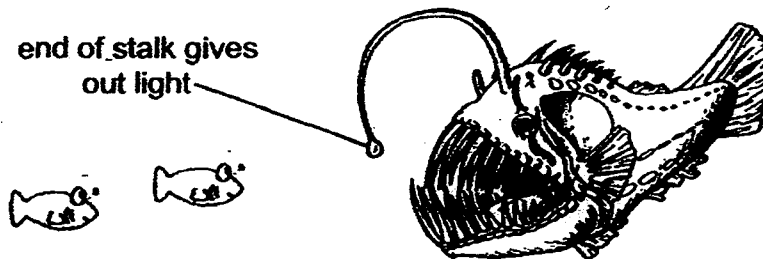

The end of the stalk on its head gives out light to attract other fish. The angler fish then feeds on them when they come closer.

(b) Explain how the other fish are able to see the light of the angler fish in the darkness.

[1m]

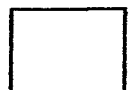

38. Ahmad removed all the leaves of plant A shown below.



Plant A

(a) What will happen to plant A after a few weeks? [1m]

(b) Explain your answer in (a). [2m]

Ahmad had another plant, Plant B. He removed all the roots of Plant B and replanted it in a garden shown below.

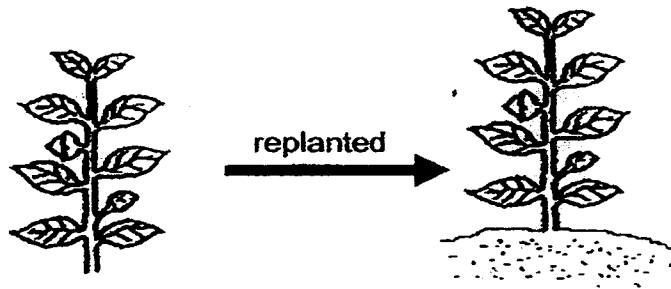

Plant B

He noticed that plant B toppled easily.

(c) Explain why. [1m]



39. John eats 90 g of food during his tea break at 3 p.m.

The table below shows the amount of undigested food in 3 different parts of the digestive system at different times.

Amount of undigested food in X at 3 p.m. (g)	Amount of undigested food in Y at 4 p.m. (g)	Amount of undigested food in Z at 5 p.m. (g)
88	40	10

(a) Which part (X, Y or Z) is likely to represent the mouth? [1m]

(b) What happens to the digested food in the small intestine? [1m]

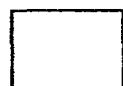

40. Study the flow chart below and answer the questions that follow.

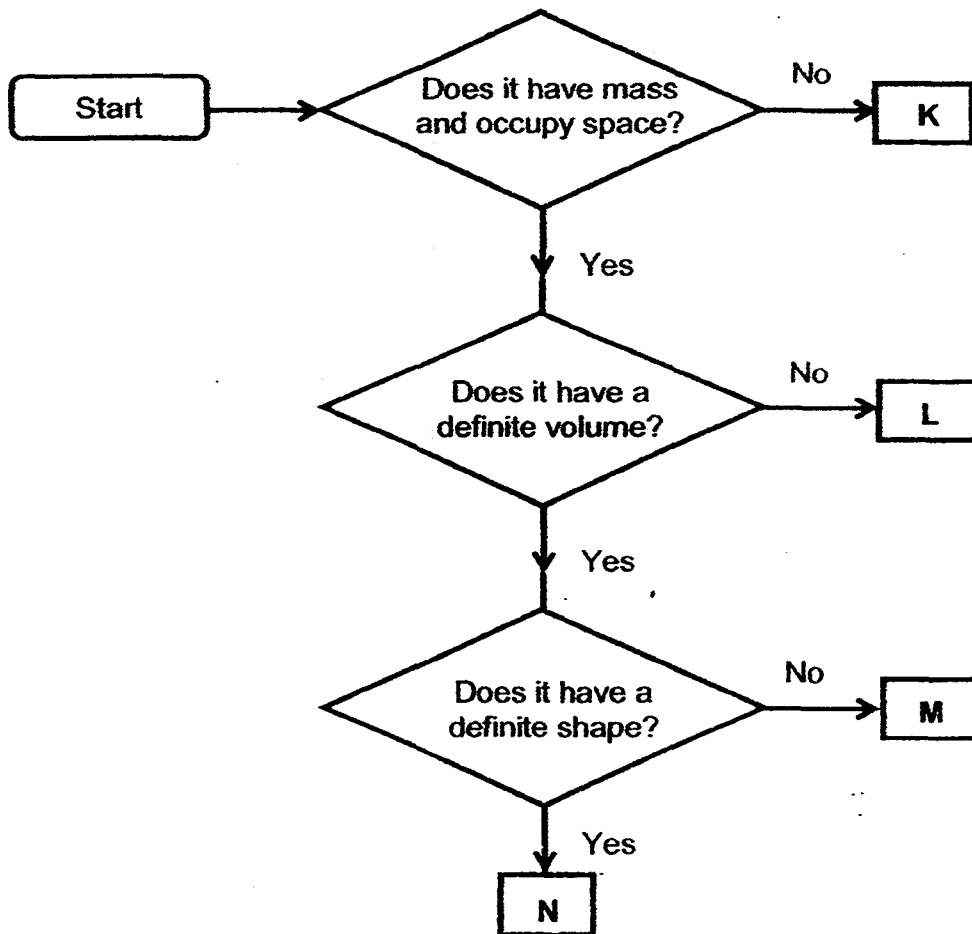

(a) Name 2 examples of K. [1m]

(b) Circle the state of L. [1m]

Solid Liquid Gas

(c) State one similarity and one difference between M and N. [2m]

Similarity: _____

Difference: _____



41. The ring is made of metal and the ball is made of glass.

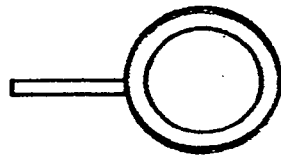

metal ring

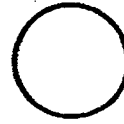

glass ball

At room temperature, the ball was unable to pass through the ring.
Susan dipped the ring into a beaker of hot water and the ball into a beaker of ice.
After which, the ball can pass through the ring.

(a) Explain clearly what has happened to the metal ring and the glass ball that enables the ball to pass through the ring. [2m]

- (i) Metal ring: _____

- (ii) Glass ball: _____

Susan had a glass jar with a metal lid.

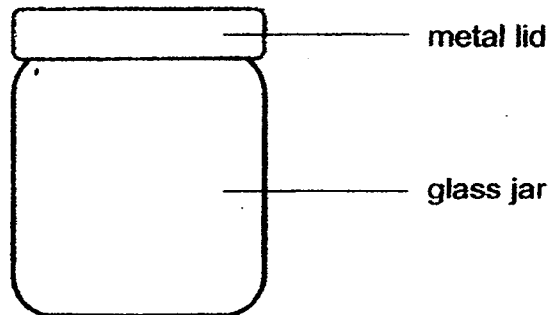

(b) She wanted to remove the lid from the jar but could not. What should she do to the metal lid and the glass jar? [2m]

- (i) Metal lid: _____

- (ii) Glass jar: _____



42. Benjamin wanted to find out how adding milk to tea affects the time taken for the tea to cool down.

He had 2 similar cups of tea, A and B, each with a temperature of 80°C. He added milk into cup A but not into cup B.

He measured the temperature of tea in cups, A and B, at five-minute intervals for 20 minutes.

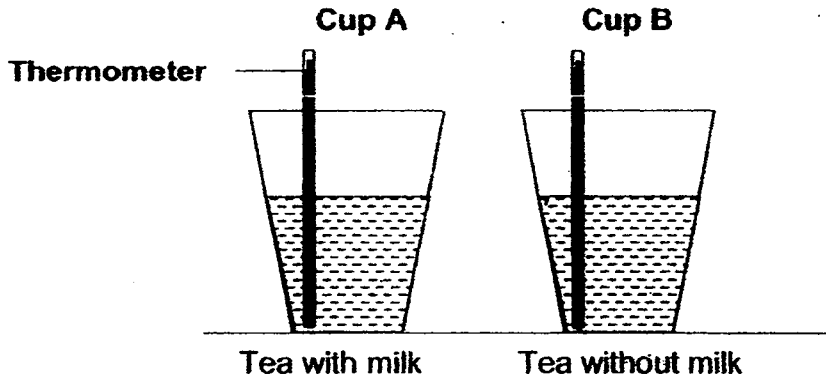

The table below shows the results of the experiment.

Time (min)	Temperature of Tea (°C)	
	Cup A	Cup B
0	80	80
5	70	60
10	60	55
15	50	45
20	40	30

- (a) Put a tick (✓) in the correct columns in the table below to indicate the type of variables in this experiment.

[2m]

Variables	Keep the same	Independent variable	Dependent variable
Amount of milk			
Material of the cup			
Temperature of tea			
Thickness of the cup			

- (b) What can Benjamin conclude from the results of the experiment?

[1m]



43. The diagram below shows a plastic stand and three discs, W, X, Y, of similar size, each with a hole in the centre. Only two of the discs are magnets.

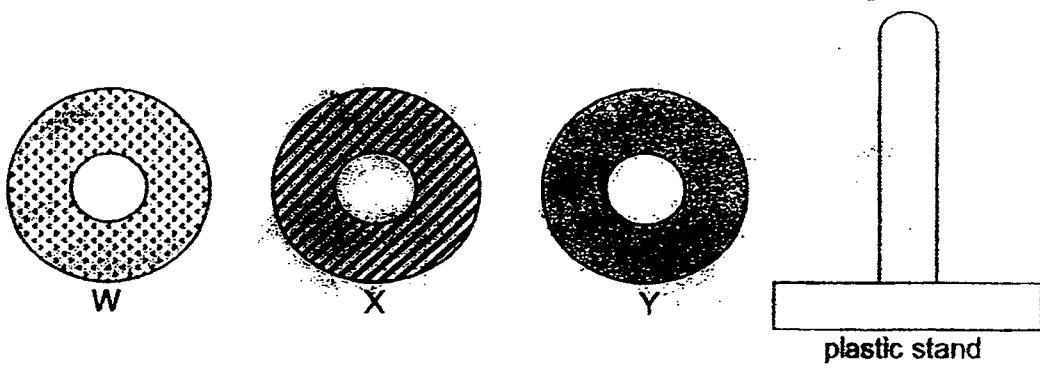

The diagrams below show the positions of the three discs when they are placed on top of one another through the plastic stand.

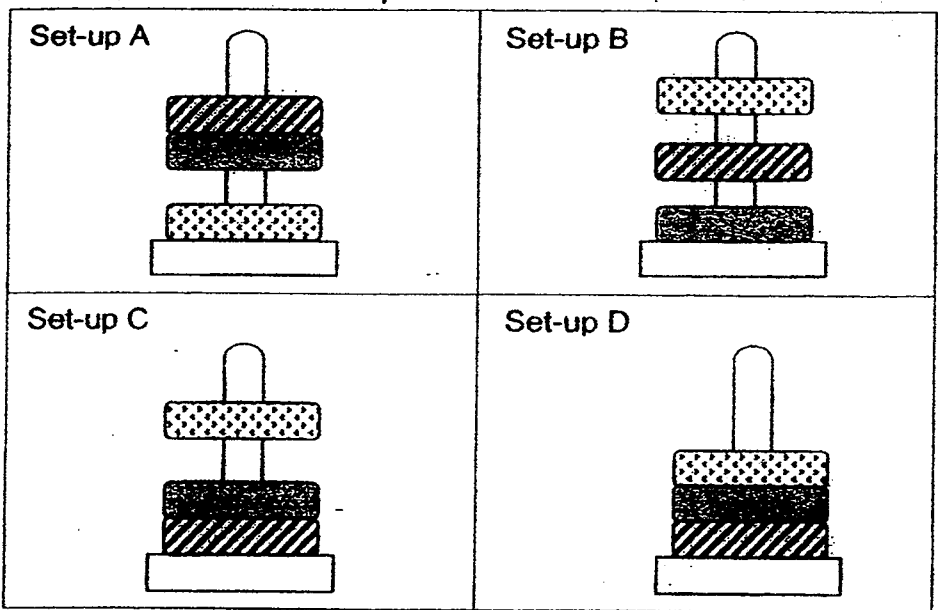

(a) Based on the information provided, which one of the above set-ups would not be possible? [1m]

(b) Explain clearly your answer in (a). [2m]

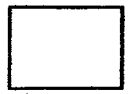

44. The diagrams below show the lifecycle of organism M and N.

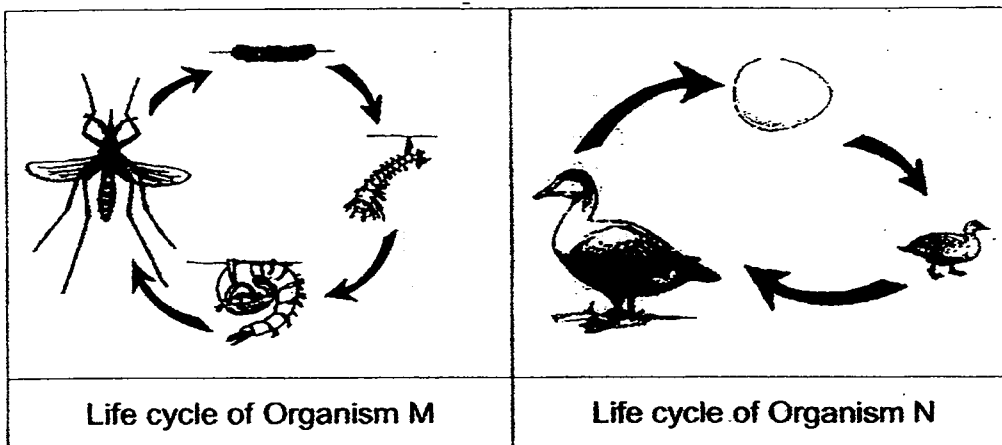

State the **differences** between the life cycles of organisms **M** and **N** for the following:

[3m]

<p>(a) Number of stages</p>	<table border="1" style="width: 100%; height: 100%; border-collapse: collapse;"> <tr><td style="height: 20px;"> </td></tr> <tr><td style="height: 20px;"> </td></tr> <tr><td style="height: 20px;"> </td></tr> <tr><td style="height: 20px;"> </td></tr> </table>				
<p>(b) Where the eggs are laid</p>	<table border="1" style="width: 100%; height: 100%; border-collapse: collapse;"> <tr><td style="height: 20px;"> </td></tr> <tr><td style="height: 20px;"> </td></tr> <tr><td style="height: 20px;"> </td></tr> <tr><td style="height: 20px;"> </td></tr> </table>				
<p>(c) Appearance of the young and the adult</p>	<table border="1" style="width: 100%; height: 100%; border-collapse: collapse;"> <tr><td style="height: 20px;"> </td></tr> <tr><td style="height: 20px;"> </td></tr> <tr><td style="height: 20px;"> </td></tr> <tr><td style="height: 20px;"> </td></tr> </table>				

End of Booklet B

Setters: Ms Evelyn Tan, Mr Yuan Kee King, Ms Peh Yunn Chyn & Mdm Nadia Abu Bakar

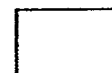

EXAM PAPER 2015

LEVEL : PRIMARY 4

SCHOOL : HENRY PARK PRIMARY SCHOOL

SUBJECT : SCIENCE

TERM : SA2

Q 1	Q 2	Q 3	Q 4	Q 5	Q 6	Q 7	Q 8	Q 9	Q 10
4	3	2	3	2	4	4	3	1	4
Q 11	Q 12	Q 13	Q 14	Q 15	Q 16	Q 17	Q 18	Q 19	Q 20
2	4	3	3	4	2	1	1	3	3
Q 21	Q 22	Q 23	Q 24	Q 25	Q 26	Q 27	Q 28	Q 29	Q 30
2	1	3	2	3	3	3	1	2	3

Q31. A: Seed

Q31. C: adult plant

Q32. Matter – air , soil

Q32. Non – matter – light

Q33. A: south

Q33 B: north

Q34a. Thermometer

Q34b. 25°C

Q35. The wax on the plastic rod melted **slower** than the wax on the metal rod, as plastic is a **poor** conductor of heat than metal.

Q36a. Because the light of the lamp was blocked by the object so a shadow will be formed on the screen.

Q36b. **SEE PICTURE** Q36c. (i) The shadow becomes darker. (ii) The shadow would be smaller.

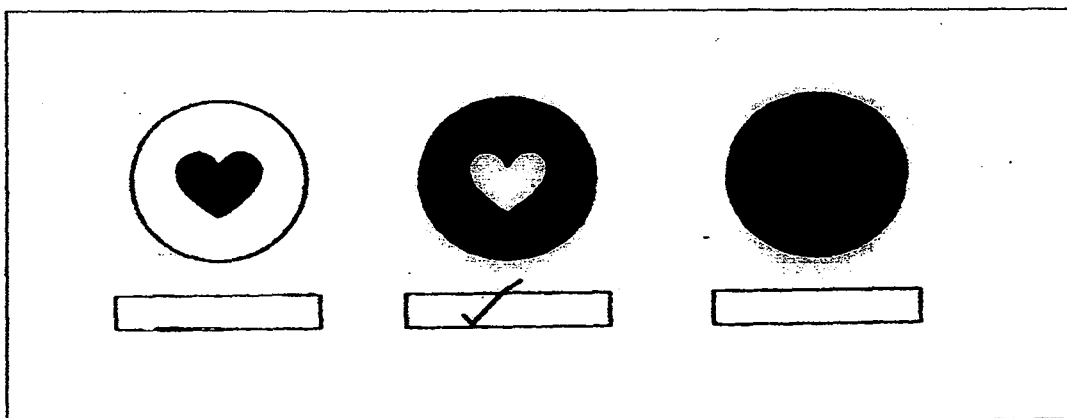

Q37a. source of light – lighted match

Q37a mirror, diamond ring, moon

Q37b. The light from the stalk reaches the eyes of the fish.

Q38a. It will die.

Q38b. Because the leaves makes food for the plant but Ahmad removed all the leaves of the plant and so it cannot make food for the plant and it will die.

Q38c. Because the roots of the plant hold the plant firmly to the ground, but when it is removed, it cannot hold the plant firmly to the ground and it will topple easily.

Q39a. Part X. Q39b. Digested food will be absorbed into the bloodstream.

Q40a. Shadow and sunlight. Q40b. Gas

Q40c. Similarity : Both M and N have mass and occupies space.

Q40c. Difference : N has a definite shape but M does not has a definite shape.

Q41a. (i) Metal ring : Because when the ring was dipped into a beaker of hot water, it gained heat and expanded.

Q41a. (ii) Glass ball: Because when the ball was dipped into a beaker of ice, it lose heat and contract.

Q41b. (i) Metal lid: Place the metal lid in a hot water.

Q41b (ii) Glass jar : Place the glass jar in a cold water.

Q42a. Amount of milk – independent variable

Q42a. Material of the cup- Keep the same

Q42a. Temperature of tea – Dependent variable

Q42a. Thickness of the cup – Keep the same.

Q42b. Tea with milk added takes a long time.

Q43a. Set up B.

Q43b. Because only magnets can repel and there is only two magnets, but all of the discs in set-up B repel, so it should be set-up B.

Q44a. Organism M has four stages of life cycle but organism N has only three stages of life cycle.

Q44b. Organism M lay their eggs in water but organism n lay their eggs on land.

Q44c. The young of organism N looks alike, but the young of organism M does not look alike to its adult.

THE END