

Name: _____ ()

Class: Primary 4 _____

CHIJ ST NICHOLAS GIRLS' SCHOOL

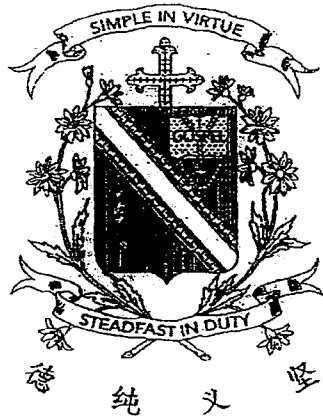

Primary 4

Semestral Assessment 2 – 2015

SCIENCE

Booklet A

29 October 2015

Total Time for Booklets A and B: 1 hour 45 minutes

30 Questions

60 Marks

Do not open this booklet until you are told to do so.

Follow all instructions carefully.



Answer all questions.

This booklet consists of 25 printed pages.

SECTION A (MULTIPLE-CHOICE QUESTIONS) [30 x 2 marks = 60 marks]

For each question from 1 to 30, four options are given. One of them is the correct answer. Make your choice (1, 2, 3 or 4). Shade the correct oval (1, 2, 3 or 4) on the Optical Answer Sheet (OAS) provided.

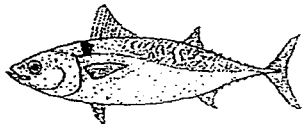
1. Study the classification table below.

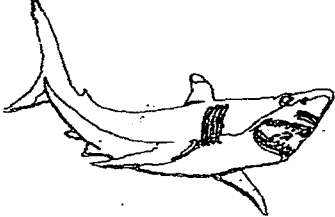
Group A	Group B
 Penguin	 Tuna
 Bat	 Shark

Which one of the following headings best represents Group A and Group B?

	Group A	Group B
(1)	Bird	Fish
(2)	Can fly	Cannot fly
(3)	Has feathers	Has scales
(4)	Breathes through lungs	Breathes through gills

2. Ahmad observed four organisms, A, B, C and D, during a trip to the zoo and recorded his observations in the table below. A tick (✓) shows the characteristic that the organism has.

Characteristic	Organisms			
	A	B	C	D
It lays eggs.		✓	✓	✓
It has scales.			✓	✓
It has two legs.		✓		
It breathes through lungs.	✓	✓		✓

Which one of the above organisms is most likely a snake?

- (1) A
 - (2) B
 - (3) C
 - (4) D
3. Which one of the following characteristics can be used to tell the similarity between amphibians and mammals?
- (1) All amphibians and mammals have moist skin.
 - (2) All amphibians and mammals have 2 pairs of legs.
 - (3) Both amphibians and mammals can only survive on land.
 - (4) Both amphibians and mammals can breathe through lungs.

4. Which one of the following statements is true for all insects?

- (1) They have wings.
- (2) They live on land.
- (3) They ~~live on~~ ^{have} feelers.
- (4) They have 3 body parts.

5. Study the classification table below.

Living Things	
K	L
Rose Plant	Bread Mould
Hibiscus Plant	Bracket Fungus
Morning Glory Plant	Toadstool

Based on the classification table above, which one of the following headings best represents K and L?

	K	L
(1)	Cannot make food	Can make food
(2)	Flowering plant	Non-flowering plant
(3)	Plants	Micro-organisms
(4)	Flowering plant	Fungi

6. The diagram below shows a Bird's Nest Fern and a Balsam plant.

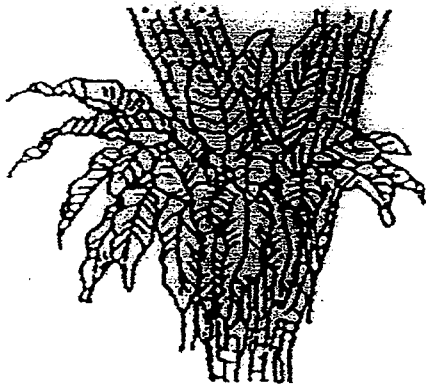

Bird's Nest Fern

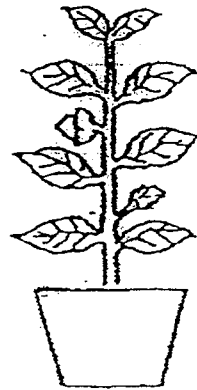

Balsam Plant

Based only on what is observable from the diagram above, which one of the following best describes both the Bird's Nest Fern and the Balsam plant?

- (1) Both bear fruits.
- (2) Both bear flowers.
- (3) Both reproduce by spores.
- (4) Both can make their own food.

7. The diagram below shows a plant.

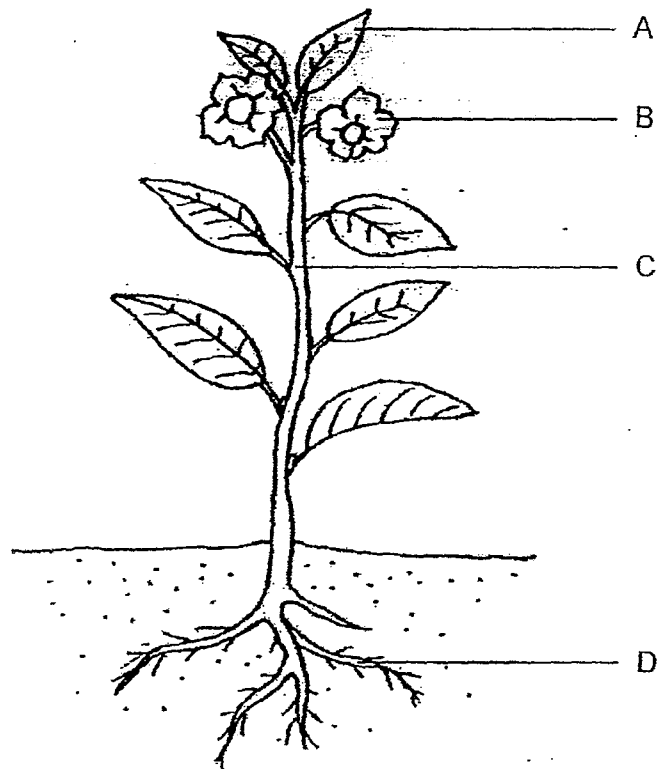

Which one of the following parts, A, B, C or D, would hold the plant upright?

- (1) A
- (2) B
- (3) C
- (4) D

8. The diagram below shows a tree.

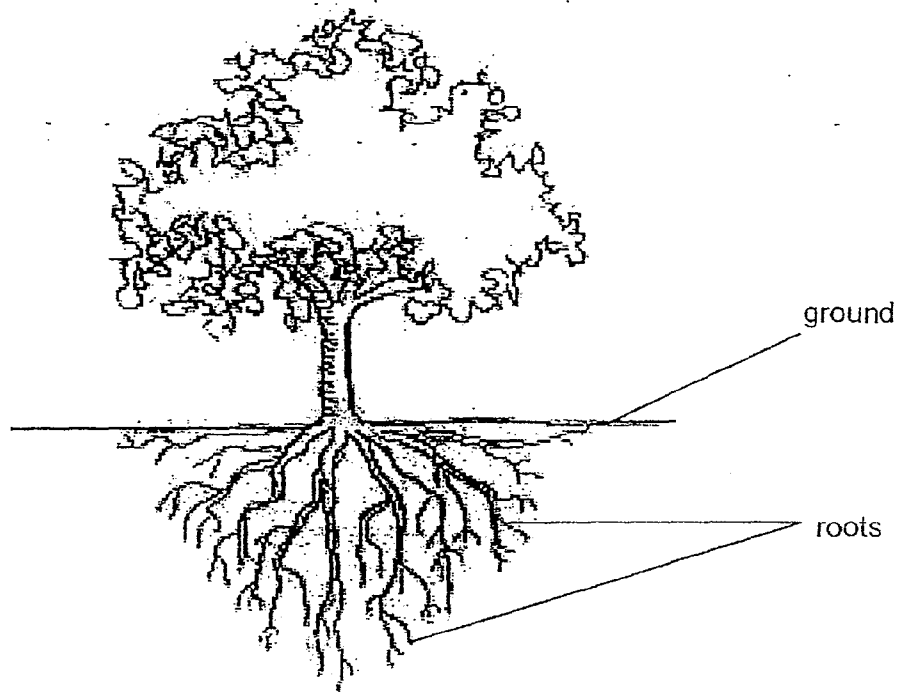

Which of the following statements best describe the roots of the tree?

- A Roots anchor the tree to the ground.
- B Roots transport water to all other parts of the tree.
- C Roots provide support for the tree to stand upright.
- D Roots spread out into the ground to reach for more water and mineral salts.

- (1) A and B only
- (2) A and D only
- (3) B and C only
- (4) C and D only

9. The diagram below shows the magnified picture of a leaf.

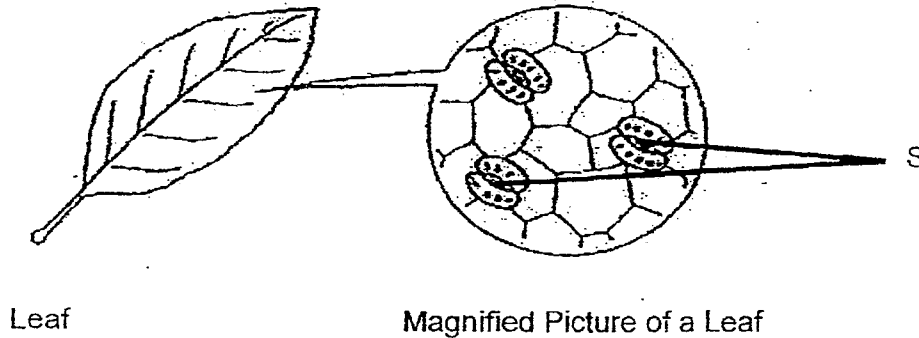

Which one of the following best describes the function of the part labelled S?

- (1) They absorb water for the plants.
 - (2) They carry food to other parts of the plant.
 - (3) They trap sunlight for the plant to make food.
 - (4) They help the plants to take in and give out gases.
10. In which part of the human digestive system is water removed from undigested food?
- (1) Gullet
 - (2) Stomach
 - (3) Small Intestine
 - (4) Large Intestine

11. Study the flowchart below carefully.

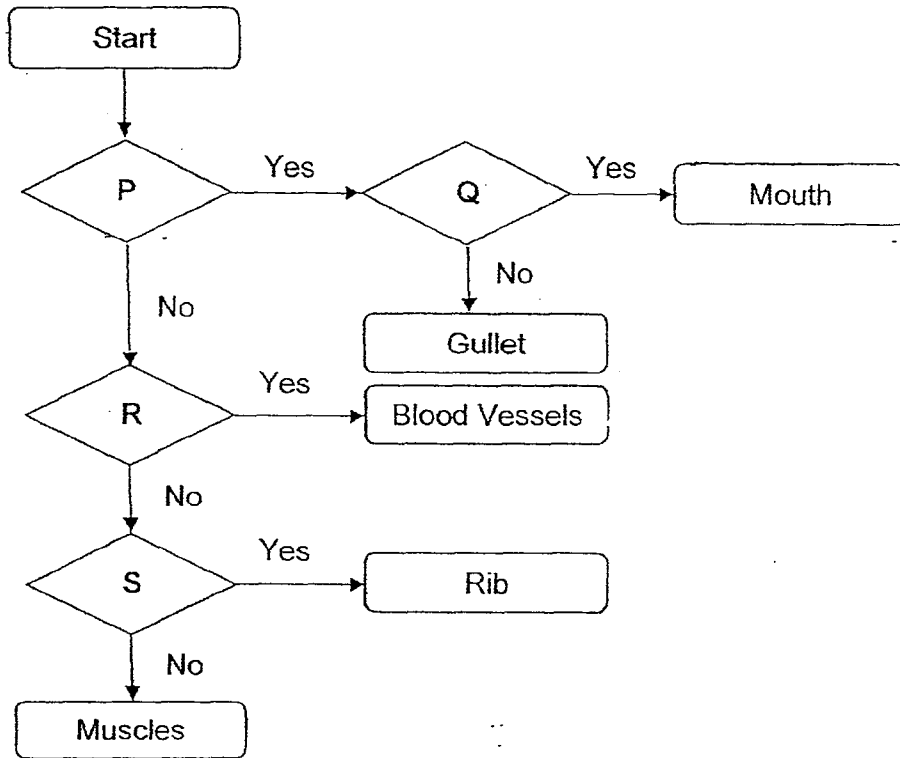

With reference to the above flowchart, which one of the following best represents P, Q, R and S?

	P	Q	R	S
(1)	Is it part of the skeletal system?	Is it part of the digestive system?	Is it part of the human body system?	Is it part of the circulatory system?
(2)	Is it part of the human body system?	Does it break down food?	Is it part of the skeletal system?	Is it part of the circulatory system?
(3)	Is it part of the digestive system?	Does it break down food?	Is it part of the circulatory system?	Is it part of the skeletal system?
(4)	Does it break down food?	Is it part of the digestive system?	Is it part of the circulatory system?	Is it part of the skeletal system?

12. The diagram below shows the growth of a young plant with two missing stages, P and Q.

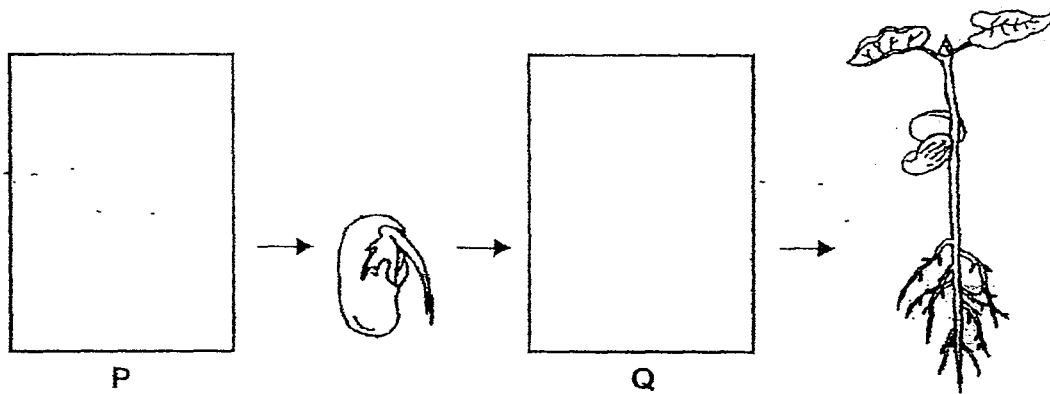

Which one of the following shows the correct stages for P and Q?

	P	Q
(1)		
(2)		
(3)		
(4)		

13. Jean observed the life cycles of Animal X and Animal Y. She then recorded her observations in the table below.

Observation	Animal X	Animal Y
Eggs are laid in water.	X	✓
It has a three-stage life cycle.	✓	✓
Each egg is covered with a shell.	✓	X

Which of the following best represents Animal X and Animal Y?

	Animal X	Animal Y
(1)	Toad	Frog
(2)	Butterfly	Toad
(3)	Penguin	Frog
(4)	Toad	Mosquito

14. Which one of the following objects can be bent easily without breaking?

(1)

Ceramic Vase



(2)

Metal Spoon



(3)

Tissue Paper



(4)

Wooden Chopsticks



15. Which one of the following is not a matter?

- (1) Air
- (2) Sand
- (3) Water
- (4) Shadow

16. Two inflated balloons are balanced as shown below.

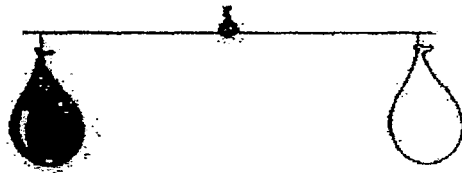

The white balloon is then deflated.

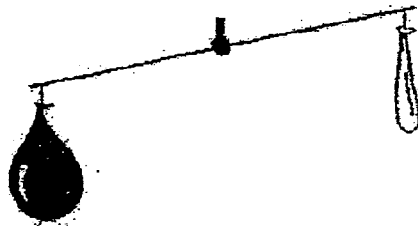

What can be concluded from this experiment?

- (1) Air has mass.
- (2) Air has no definite volume.
- (3) The mass of the black balloon has increased.
- (4) Different coloured balloons have different masses.

17. The diagram below shows 3 containers, X, Y and Z, of different shapes and sizes. Agnes pours 50 cm^3 of water into X. Then, she pours that amount of water from X to Y and finally from Y to Z.

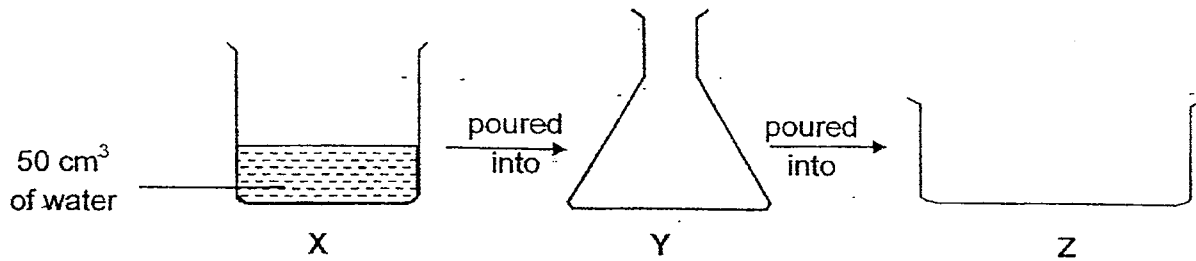

Which one of the following statements best explains what Agnes could have observed as she was pouring the water from X to Y and from Y to Z?

- (1) The volume of the water increases.
- (2) The volume of the water decreases.
- (3) The water takes the shape of the container it is in.
- (4) The level of the water is the highest in container Y.

18. The diagram below shows a container which has a volume of 250 cm^3 . A syringe is then attached to the side of the container and 40 cm^3 of air was then removed from the container as shown below.

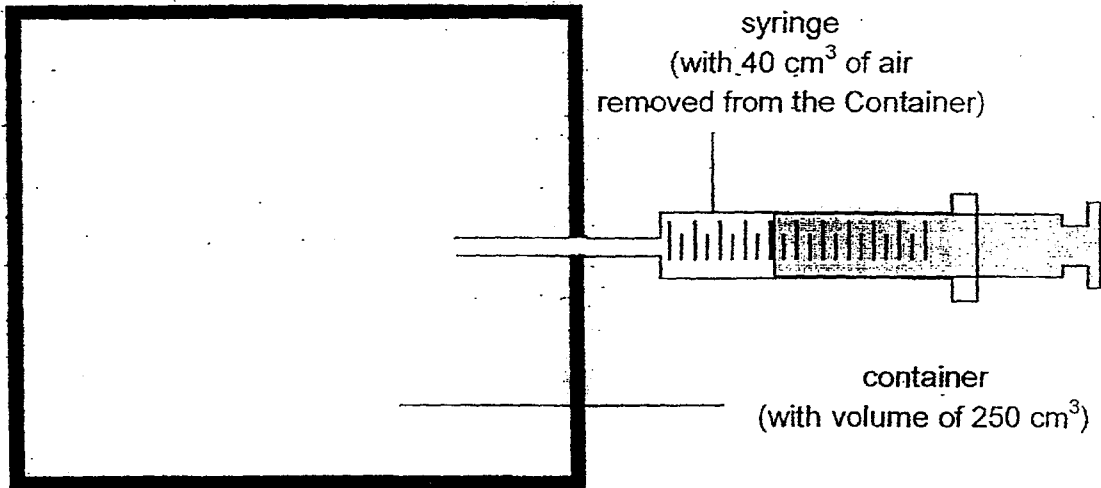

What is the final volume of air in the container?

- (1) 200 cm^3
- (2) 210 cm^3
- (3) 250 cm^3
- (4) 290 cm^3

19. An object X was attracted to a magnet, as shown in the diagram below.

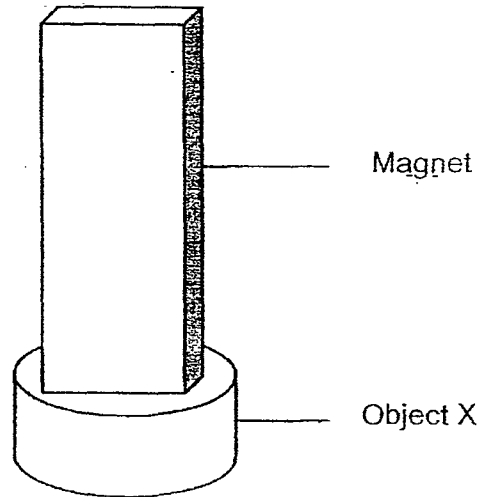

Object X is made of _____

- (1) Steel
- (2) Plastic
- (3) Copper
- (4) Aluminium

20. Five identical bar magnets and two similar compasses, A and B, were arranged as shown in the diagram below.

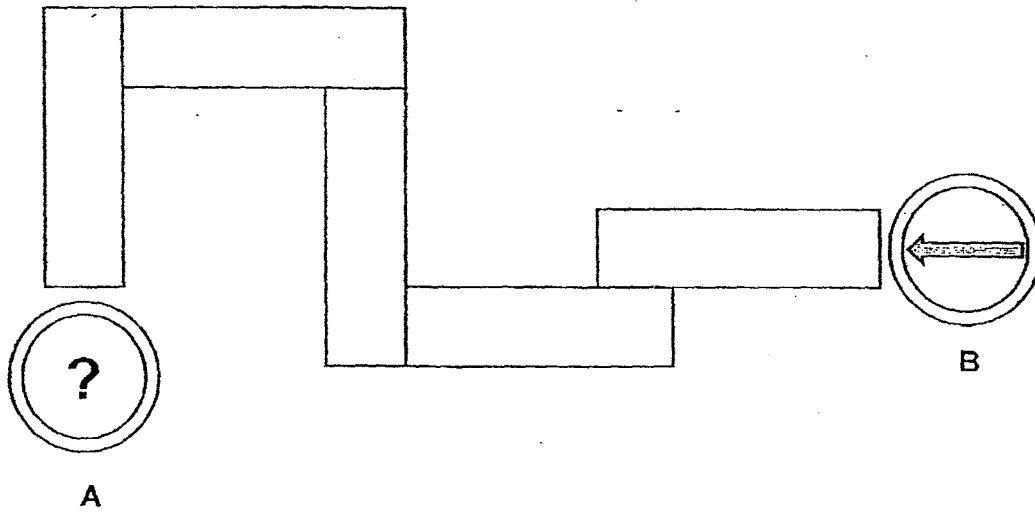

Which one of the following shows the direction of the compass needle at A?

(1)

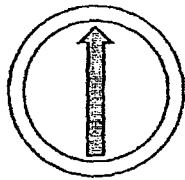

(2)

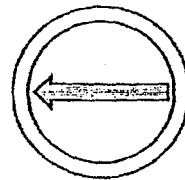

(3)

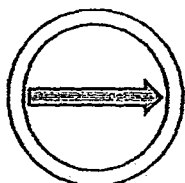

(4)

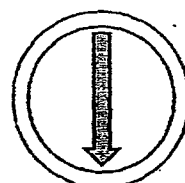

21. The diagram below shows a set up to create an electromagnet. The iron nails, wires and batteries used in each set up, A, B, C and D, are identical.

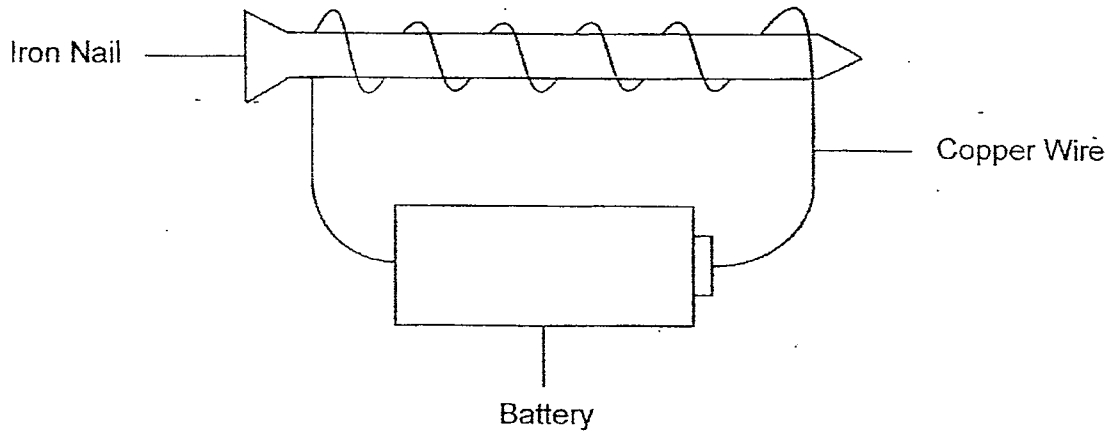

The number of coils around each nail in each set up is different as shown in the table below.

Set-up	Number of coils around the nail
A	20
B	50
C	10
D	25

Arrange the magnetic strength of the electromagnets in the four set ups from the strongest to the weakest.

- (1) A, D, B and C
- (2) B, D, A and C
- (3) C, A, D and B
- (4) D, A, B and C

22. Which one of the following is not a source of light?

- (1) Sun
- (2) Lamp
- (3) Moon
- (4) Candle Flame

23. The diagram below shows a wooden stick that was placed in the middle of the school field. The length of the shadow cast by the wooden stick was measured at different times of the day.

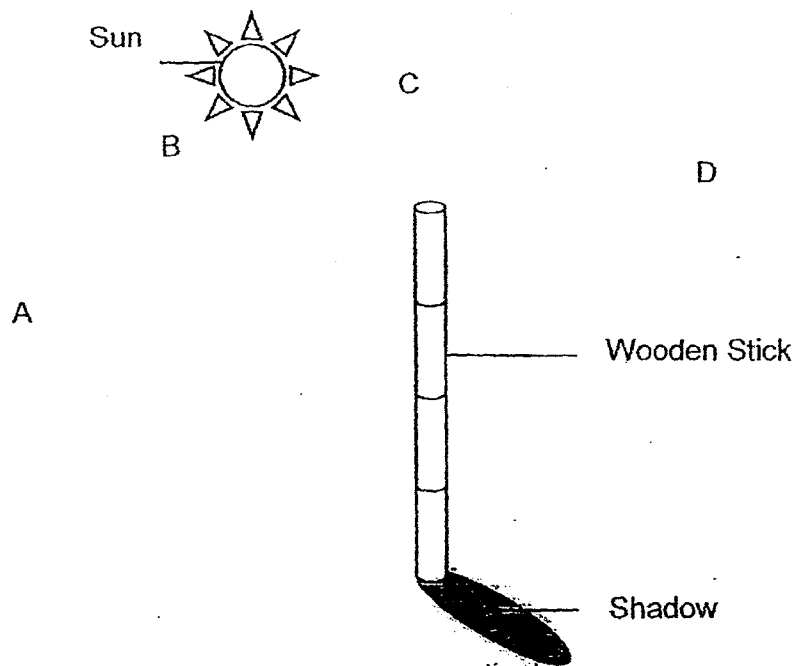

At which point, A, B, C or D, was the Sun's position when the shadow of the wooden stick was the shortest?

- (1) A
- (2) B
- (3) C
- (4) D

24. The diagram below shows a bent tube.

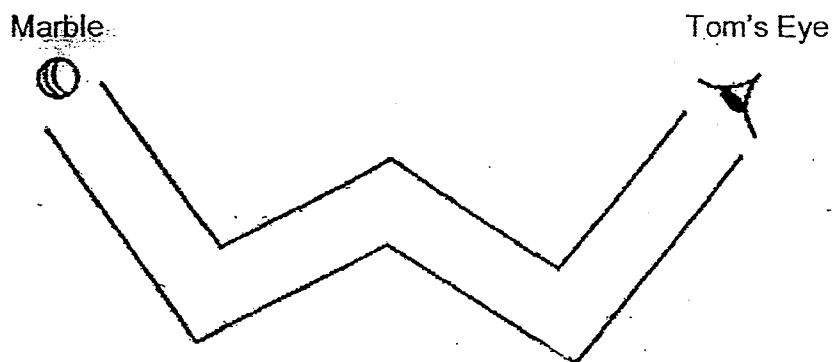

What is the least number of mirrors that has to be placed inside the bent tube so as to enable Tom to see the marble?

- (1) 2
- (2) 3
- (3) 4
- (4) 5

25. Bernice conducted an experiment to measure the amount of light that can pass through a material. Inside a dark room, she used a torch and a datalogger that is connected to a light sensor to test four different materials, P, Q, R and S. She then recorded her results in the table below.

Material	Amount of light (lux) that passes through the material
P	30
Q	40
R	20
S	15

Based only on the results shown in the table above, which one of the materials, P, Q, R or S, is most suitable to be made into part X of the pair of spectacles shown below?

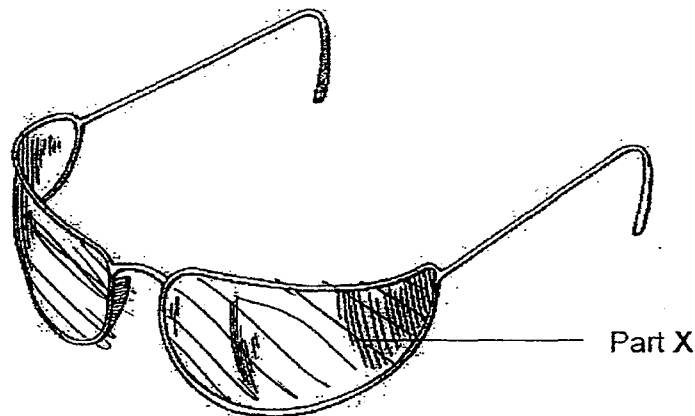

A Pair of Spectacles

- (1) P
- (2) Q
- (3) R
- (4) S

26. Kumar filled two containers, X and Y, with 500 ml of boiling water each as shown in the diagram below. He then covered each container with a sheet of glass and left them in a room for 30 minutes.

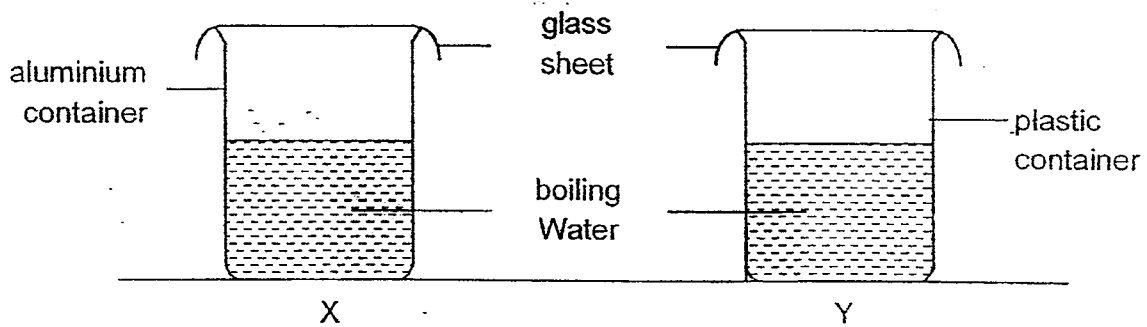

Which one of the following line graphs best represents the changes in the temperature of the water in the two containers above?

(1)

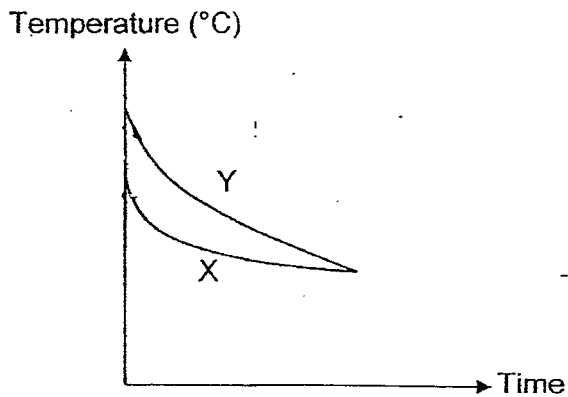

(2)

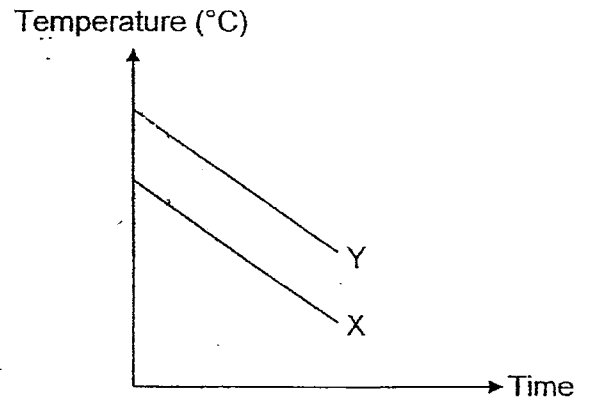

(3)

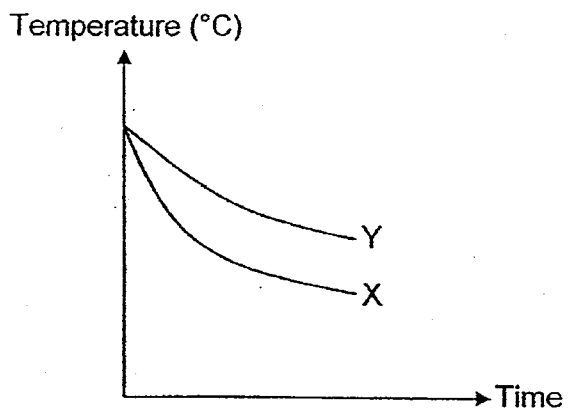

(4)

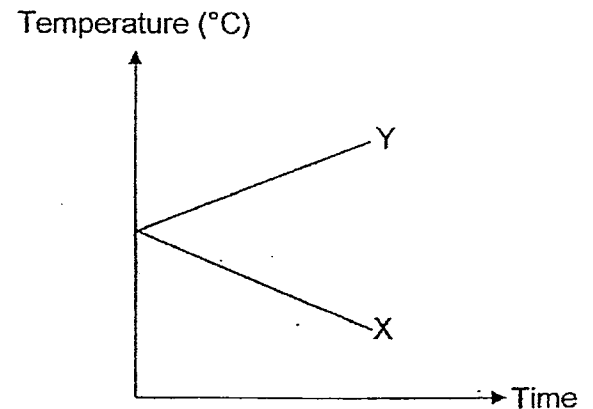

27. The diagram below shows a square metal frame. Four drops of wax were attached at points, P, Q, R and S, along the square metal frame as shown below.

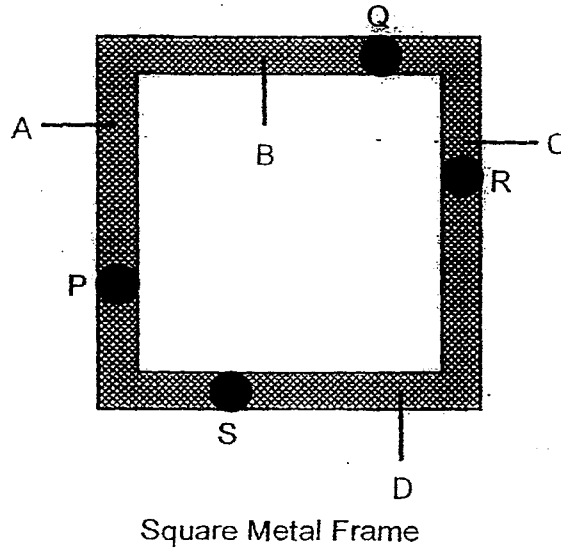

Taufik heated the square metal frame at a certain point along the frame and recorded the time taken for each drop of wax to melt in the table below.

Position of the drop of wax	Time taken (s) for the drop of wax to melt
P	48
Q	12
R	35
S	90

Based only on the results shown in the table above, at which point, A, B, C or D, did Taufik most likely heat the metal frame?

- (1) A
- (2) B
- (3) C
- (4) D

28. The diagram below shows what happened to a dented ping pong ball before and after it was placed in a basin of hot water.

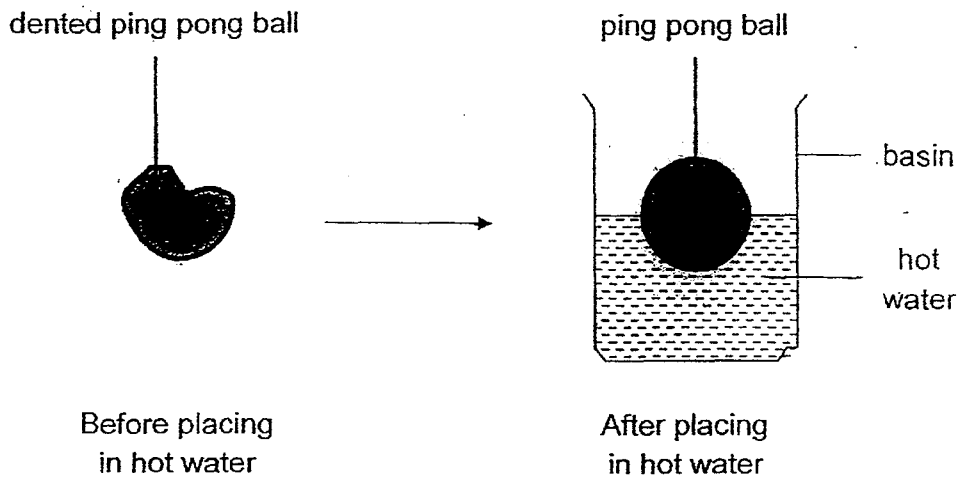

Which one of the following statements best explains the above observation?

- (1) The ping pong ball lost heat and contracted.
- (2) The ping pong ball gained heat and expanded.
- (3) The air trapped in the ping pong ball lost heat and contracted
- (4) The air trapped in the ping pong ball gained heat and expanded.

29. Ronald placed a metal spoon in a cup of hot tea as shown below.

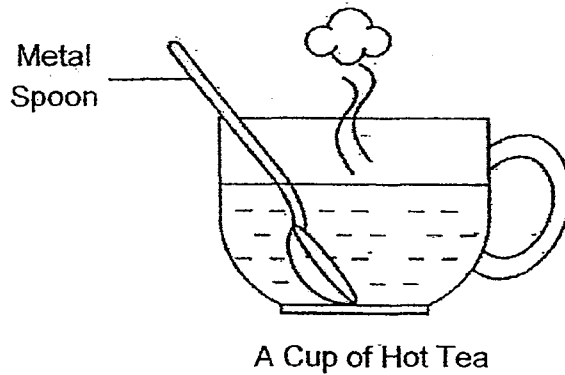

After 10 minutes, he touched the handle of the spoon and realised that it was hot. Which one of the following statements best explains the above observation?

- (1) The cup lost heat to the hot tea.
- (2) The spoon lost heat to the hot tea.
- (3) The spoon gained heat from the hot tea.
- (4) The hot tea gained heat from the spoon.

30. Hisham boiled some water in the pot as shown below.

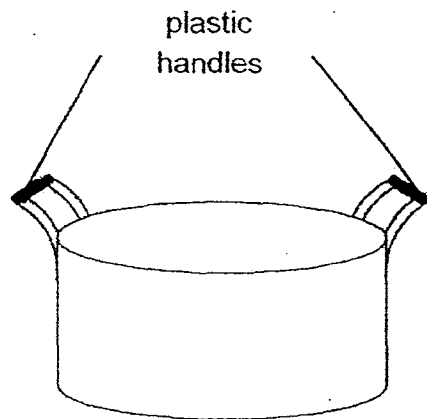

pot containing boiling water

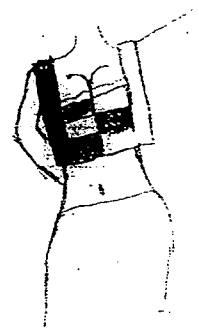

He was given 4 materials, A, B, C and D, whose properties are shown in the table below.

Material	Property of Material Given	
	Can bend easily without breaking	Can conduct heat easily
A	Yes	Yes
B	Yes	No
C	No	No
D	No	Yes

Based only on the results in the table above, which material is most suitable for making the plastic handles that would allow Hisham to hold the pot of boiling water without getting burnt?

- (1) A
- (2) B
- (3) C
- (4) D

END OF BOOKLET A



Name: _____ ()

Class: Primary 4 _____

CHIJ ST NICHOLAS GIRLS' SCHOOL

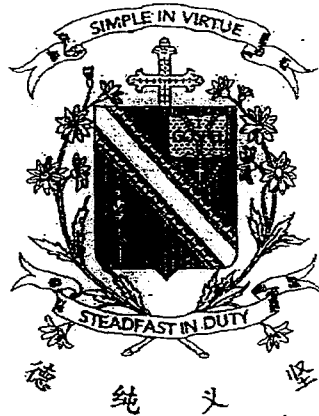

Primary 4

Semestral Assessment 2 – 2015

SCIENCE

Booklet B

29 October 2015

Total Time for Booklets A and B: 1 hour 45 minutes

14 Questions

40 Marks

Do not open this booklet until you are told to do so.

Follow all instructions carefully.

Answer all questions.

This booklet consists of 16 printed pages.

Booklet A	60
Booklet B	40
Total	100
Parent's Signature / Date	

SECTION B (OPEN-ENDED QUESTIONS) [40 marks]

For questions 31 to 44, write your answers in this booklet. The number of marks available is shown in the brackets [] at the end of each question or part question.

31. Study the flowchart given below.

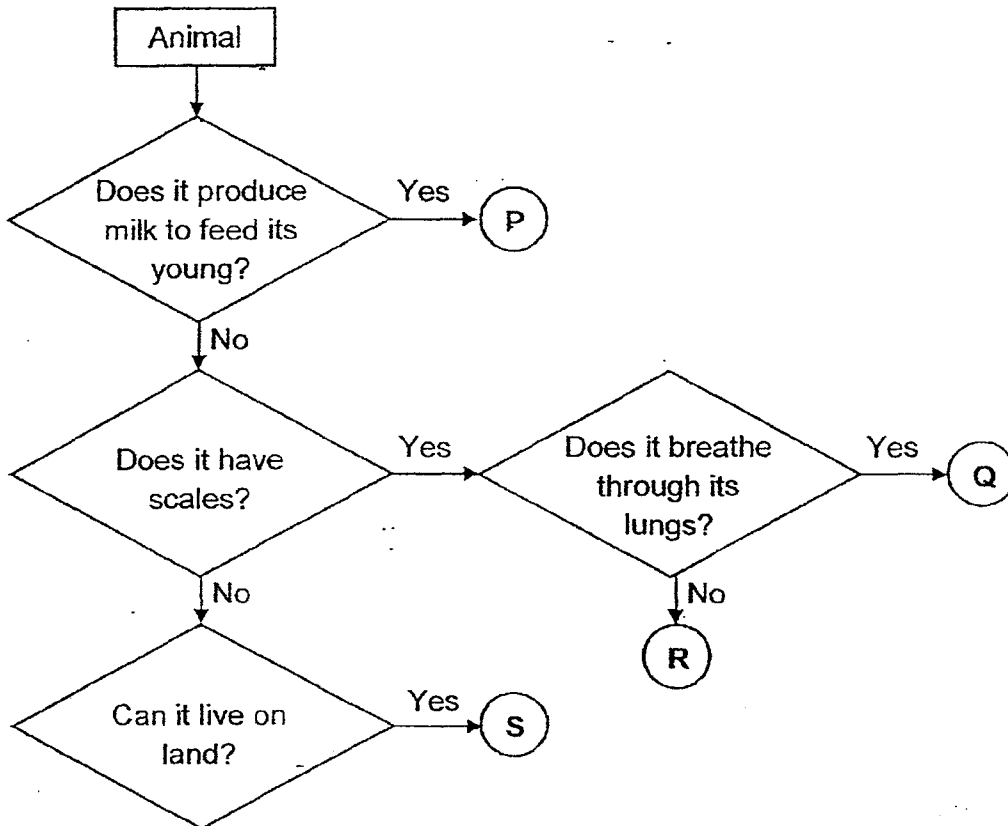

(a) Using the flowchart above, state the similarities between Q and R. [2]

(b) Using the flowchart above, which of the above letters, P, Q, R or S, best represents the animals shown below? (Write only the letters.) [2]

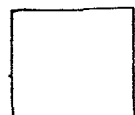
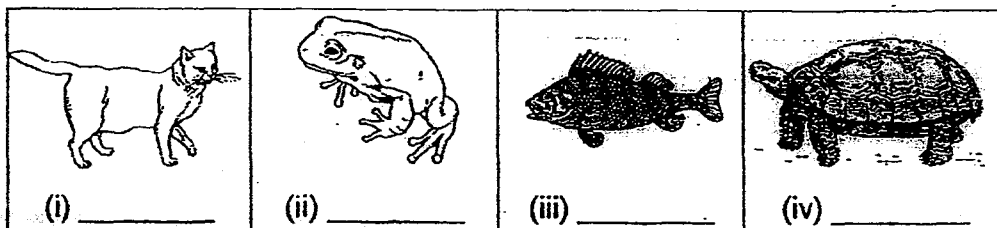

32. Study the flowchart given below.

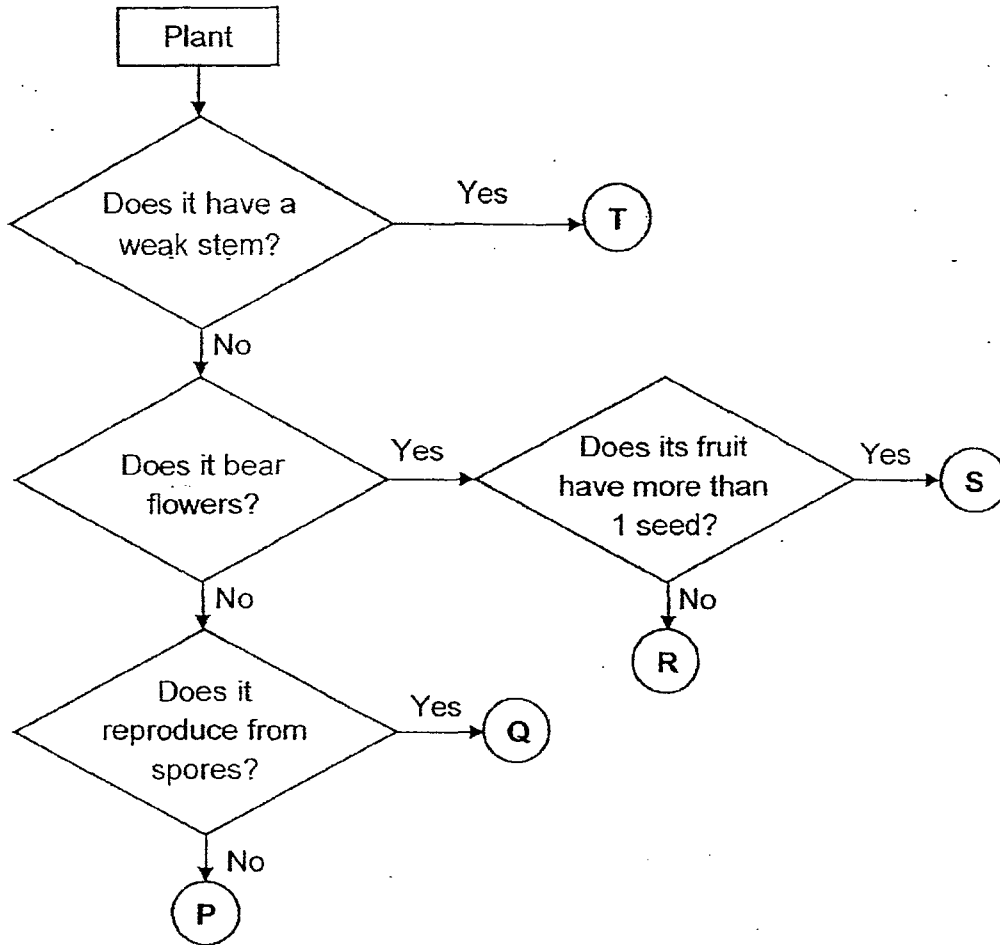

(a) Using the flowchart above, identify the following organisms. Write the correct letters, P, Q, R, S or T, in the boxes provided below. [2]

Mango:

Moss:

Tomato:

Money Plant:

(b) Based on the flowchart above, can a mushroom also be represented by the letter Q? Explain your answer. [1]



33. The diagram below shows a motorcycle helmet. The part of the helmet that covers the rider's head is indicated by part X.

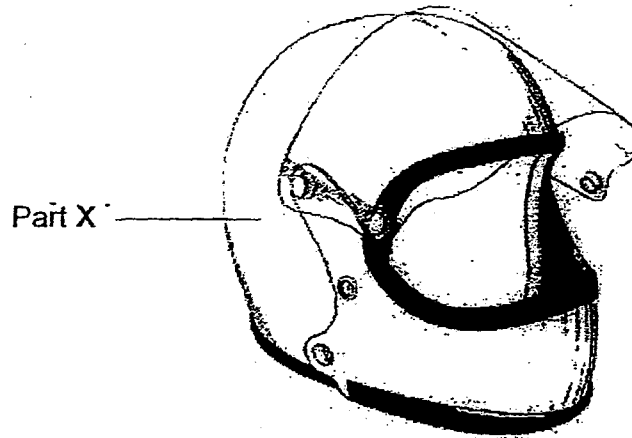

Motorcycle Helmet

- (a) Name the human body system that performs the same function as part X of the helmet. [1]

_____ System

- (b) State one similarity between the function of the human body system stated in (a) and part X of the helmet. [1]



34. The diagrams below show the life cycles of a grasshopper and a butterfly.

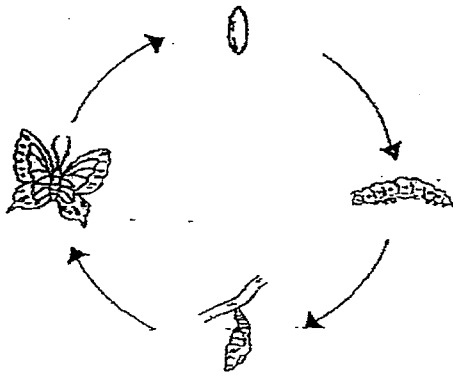

Life Cycle of a Butterfly

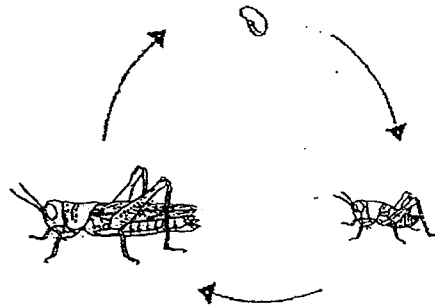

Life Cycle of a Grasshopper

(a) State one difference between the life cycle of a grasshopper and the life cycle of a butterfly. [1]

(b) At which stage of the life cycle of a butterfly is the organism considered a pest to farmers? [1]

(c) Give one reason for your answer in (b). [1]



35. The diagram below shows a bus.

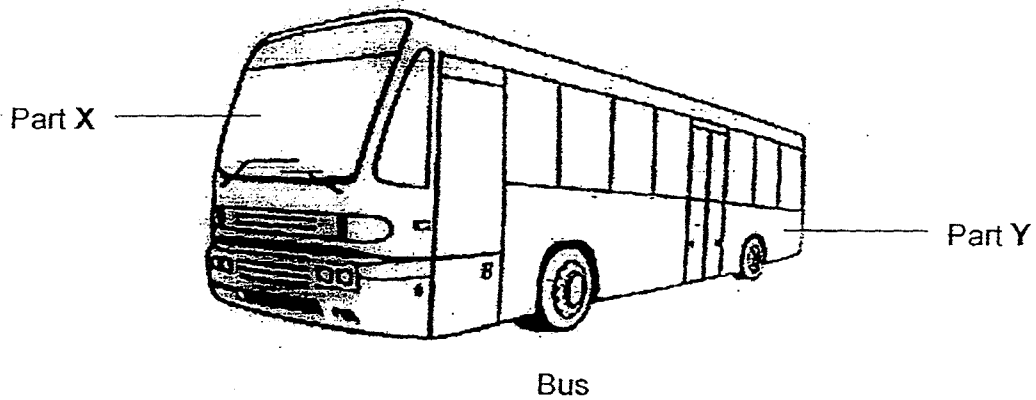

(a) Part X is made of glass because it allows _____ to pass through so that the bus driver can see the road. [1]

(b) Part Y is made of _____ because Y has to be strong. [1]

36. The diagram below shows a baby's milk bottle.

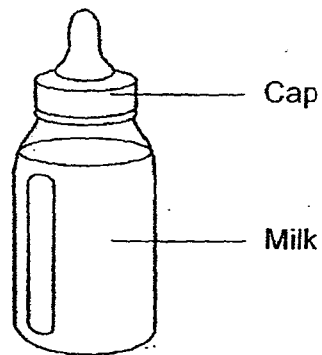

Baby's Milk Bottle

Circle the correct state of matter for the following items.

(a) Cap: Solid / Liquid / Gas [1]

(b) Milk: Solid / Liquid / Gas [1]



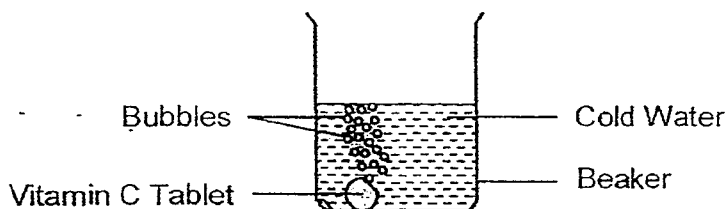

37. During Science Week, Angela learnt that she was able to construct a self-made mini rocket using a Vitamin C tablet. When this tablet was put into a beaker of cold water, many bubbles were produced immediately. She also noticed that the tablet eventually became smaller and disappeared.



(a) What change in state of matter has taken place in the Vitamin C tablet after it has been put into the beaker of cold water? [1]

(b) Angela then decided to launch her mini rocket into the air with different amounts of tablet. She repeated this experiment three times and the results were recorded in the table shown below.

Amount of Vitamin C Tablet Used		Time taken (s) for the mini rocket to launch		
		1 st Attempt	2 nd Attempt	3 rd Attempt
Half		11	10	10
Three-Quarter		8	7	8
Whole		5	5	4

(i) What is the relationship between the amount of Vitamin C tablet used and the time taken for the mini rocket to launch? [1]

(ii) Predict the time taken for the mini rocket to launch if she used two whole Vitamin C tablets. [1]

_____ seconds



38. Richard used a syringe to collect 20 cm^3 of water as shown in the diagram below. He sealed the end of the syringe and then tried to push in the plunger.

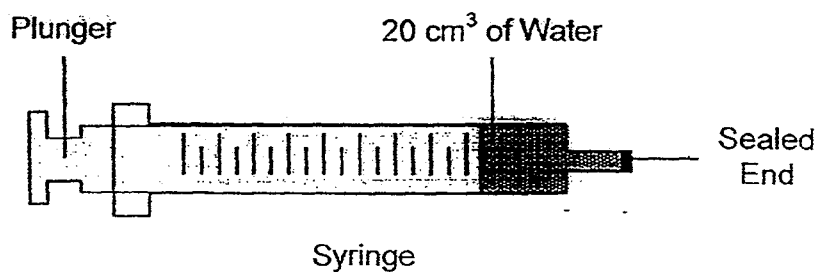

- (a) What would Richard observe about the volume of water in the syringe when he tried to push in the plunger? [1]

- (b) The volume of water in the syringe was later replaced with 20 cm^3 of air. What would Richard observe about the volume of air when he then tried to push in the plunger? [1]

- (c) Explain your observation in (b). [1]



39. Alice placed two ring magnets, A and B, through a holder as shown below.

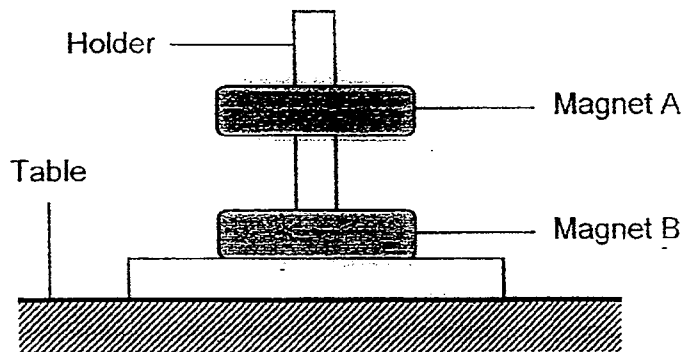

(a) The holder is made of wood. Suggest a reason why the holder did not attract the magnets? [1]

(b) Magnet A was observed 'floating' above magnet B. Explain this observation. [1]

In another experiment, Alice dropped a bar magnet into a box of nails. When she picked up the magnet, she observed that most nails were attracted to the ends of the magnet as shown in the diagram below.

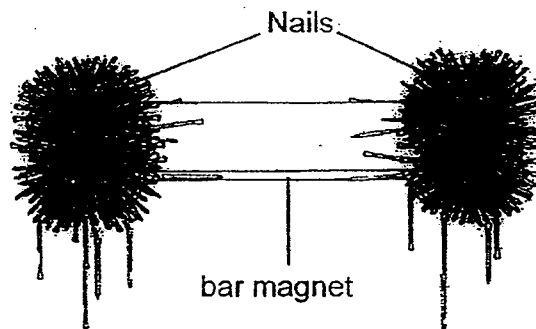

(c) Explain Alice's observation. [1]



40. Peter wanted to find out if the number of batteries affected the strength of the electromagnet. He had two set ups, A and B, as shown below.

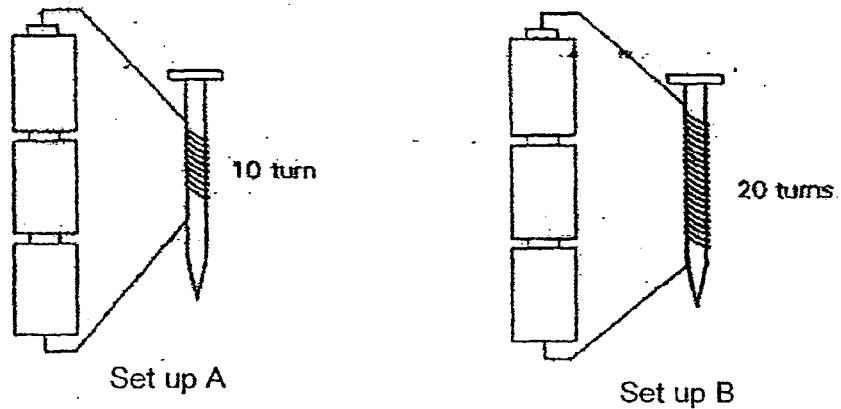

Peter's teacher said that he did **NOT** conduct a fair test.

Suggest two ways in which Peter could do to ensure that he conducted a fair test. [2]

Suggestion 1 :

Suggestion 2:



41. The set up below uses a light sensor to count the number of identical objects on a moving belt.

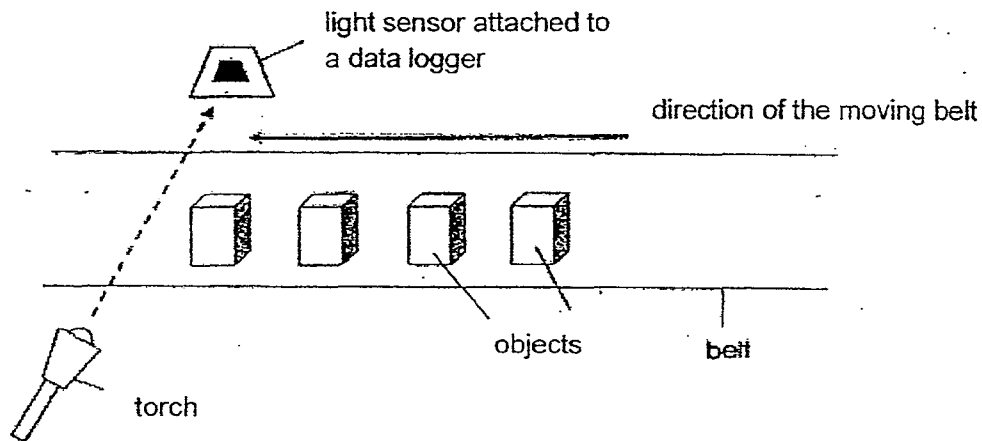

The belt moves at a constant speed. When the object is between the torch and the light sensor, it blocks the light from reaching the light sensor. The data recorded is shown in the graph below.

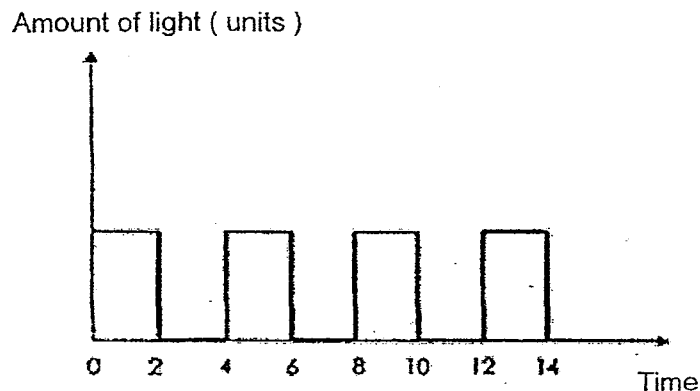

- (a) Based on the graph, how many objects passed the light sensor in 14 seconds? [1]

- (b) The set up can count 20 objects in a minute when the belt is moving at its maximum speed. State one way to count more than 20 objects in a minute without changing the speed of the belt. [1]

- (c) The set up cannot be used to count objects made of glass. Explain why. [1]



42. In a dark room, John placed a torch and a cardboard with a hole in front of a screen as shown below. He then switched on the torch and a bright spot was observed on the screen.

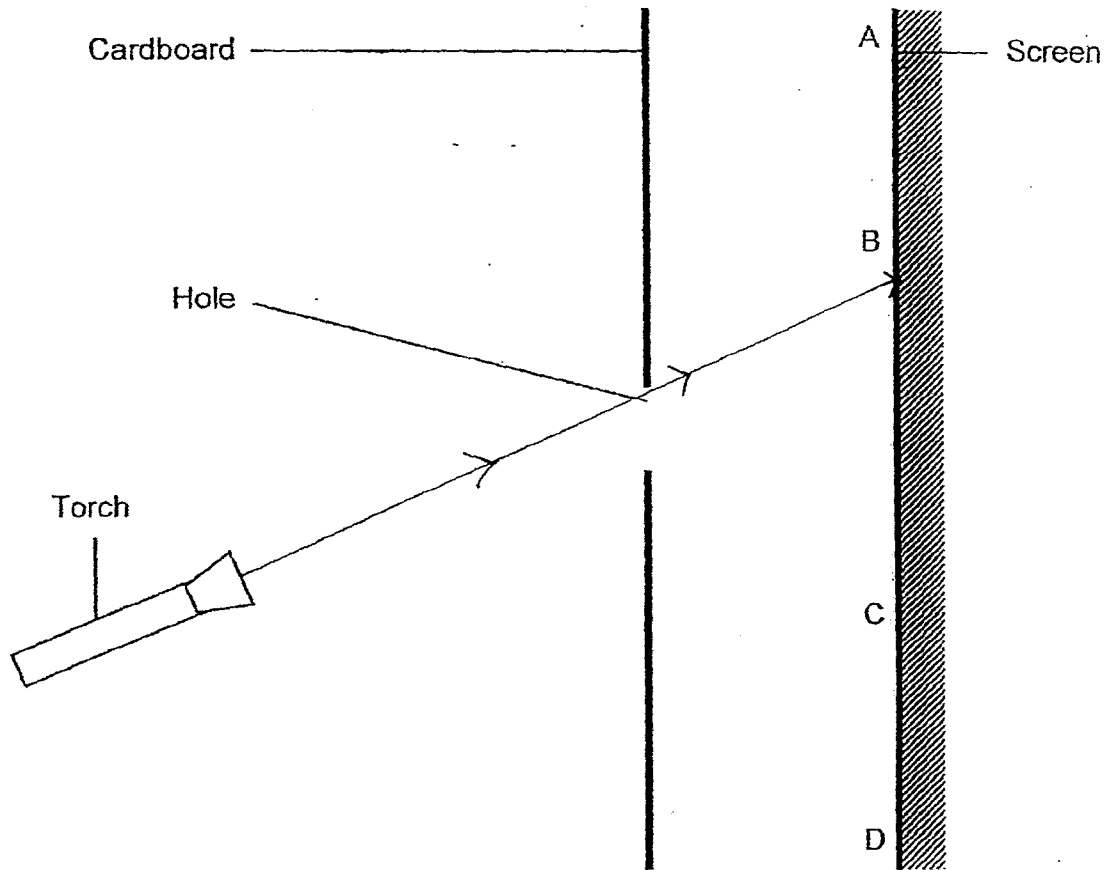

- (a) State which point on the screen, A, B, C or D, was the bright spot most likely observed? [1]

- (b) John also noticed that there were no bright spots observed on the other points on the screen. Explain this observation. [1]



(c) John later replaced the cardboard with a toy dinosaur. The toy dinosaur was placed at the same position as where the hole of the cardboard was. Upon switching on the torch, he observed a dark shadow of the toy dinosaur on the screen.

(i) Explain how the dark shadow of the toy dinosaur was formed. [1]

(ii) Describe how the size of the dinosaur's dark shadow will change if John moves his dinosaur closer to the screen. [1]



43. The diagram below shows 2 set ups, S and T. The beakers were placed above two bunsen burners and heated for 10 minutes.

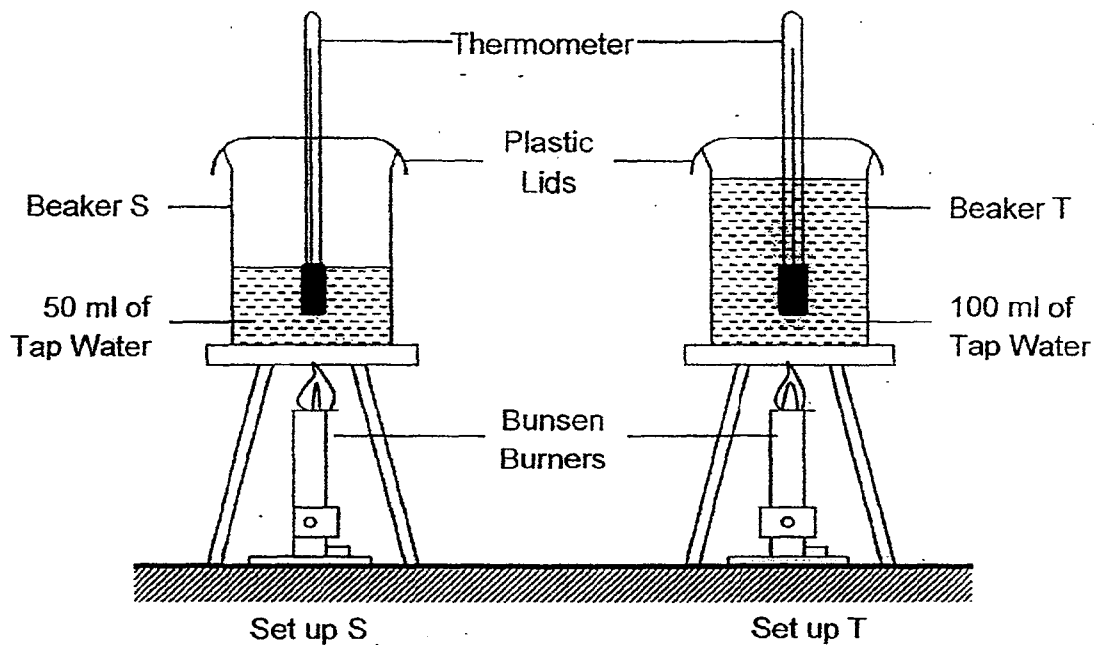

The temperatures of the water in both beakers were recorded and shown on the graph below.

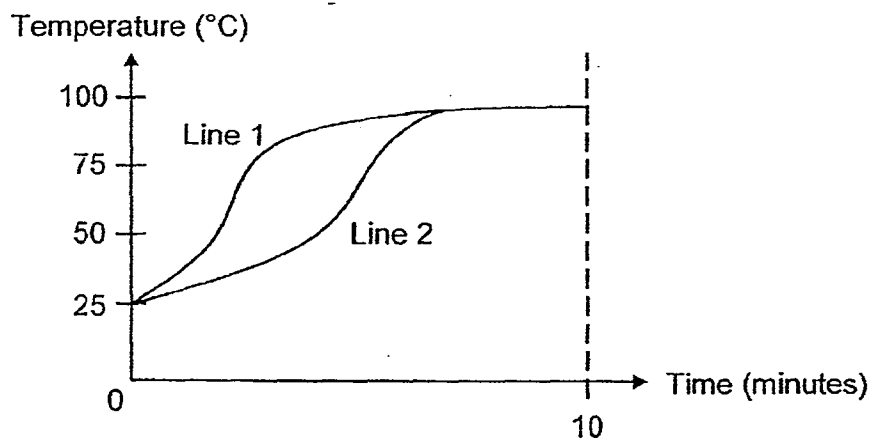

- (a) State which line, 1 or 2, of the graph above, would represent beakers S and T.

[1]

Line 1:

Line 2:

- (b) Based on your answer in (a), compare and explain the difference in the changes in temperature shown by the graph up to the 10th minute. [2]

After the 10th minute, the water in beaker T was still being heated continually. It was observed that the temperature of the water in beaker T was starting to decrease gradually.

- (c) Without the removal of any water from beaker T, suggest what could have been done that might have resulted in the above observation?

[1]



44. Larry placed equal amounts of wax at the ends of two rods, a metal rod and a plastic rod. He then placed both rods into a container of boiling water as shown in the diagram below.

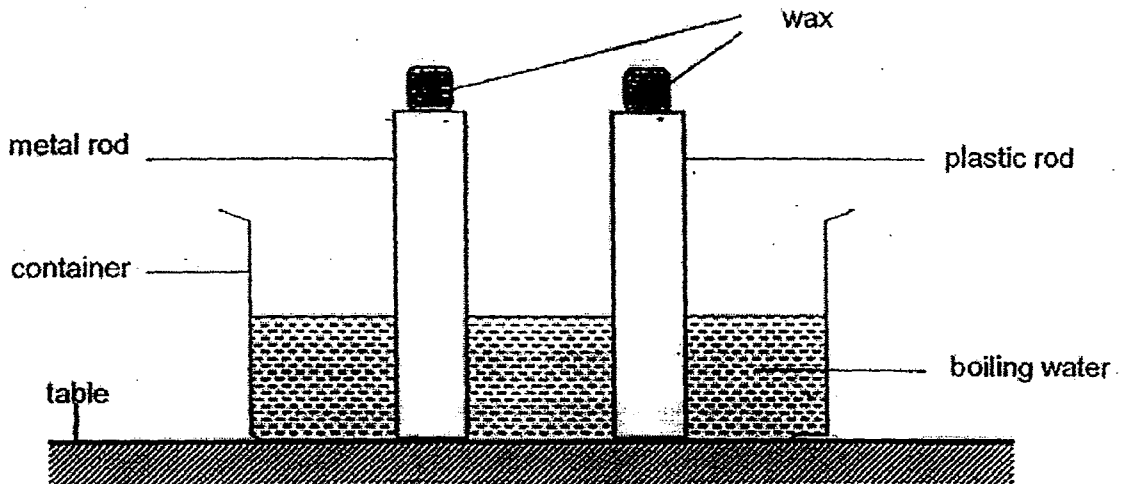

- (a) State on which rod, metal or plastic, would the wax melt first. [1]

- (b) Give a reason for your answer in (a). [1]

END OF BOOKLET B



EXAM PAPER 2015

SCHOOL : CHIJ ST NICHOLS GIRLS' SCHOOL

SUBJECT : P4 SCIENCE

TERM : SA2

Q1	Q2	Q3	Q4	Q5	Q6	Q7	Q8	Q9	Q10
4	4	4	4	4	4	3	2	4	4
Q11	Q12	Q13	Q14	Q15	Q16	Q17	Q18	Q19	Q20
3	4	3	3	4	1	3	3	1	4
Q21	Q22	Q23	Q24	Q25	Q26	Q27	Q28	Q29	Q30
2	2	3	2	2	4	2	4	3	3

31)a) They both do not produce milk to feed its young and both have scales.

b)i)P ii)S iii)R iv)Q

32)a) Mango: R Moss: Q Tomato: S Money plant:T

b) No. As mushroom are fungi and not a plant.

33)a) Skeletal b) They both protect the rider's head from getting hurt.

34)a) The butterfly has a four-stage life cycle but the grasshopper has three-stage life cycle.

b) At the larval stage.

c) As caterpillars need to eat, they would eat up the leaves of a plant, causing the plant to die as the leaves cannot make food for the plant.

35)a) light b) metal 36)a) Solid b) Liquid

37)a) Solid to gas.

b)i) The bigger the tablet, the lesser time is taken for the mine rocket to launch.

ii)1-4 seconds

38) a)The volume of water would not change.

b) The volume of air in the syringe will decrease.

c) As air cannot be compressed and does not have a definite volume, Richard was able to push in the plunger.

39)a) it was not magnetic.

b) As their like poles were facing each other, they were repelling.

c) The magnetic strength was strongest at its poles.

40) Suggestion 1: he should change the number of batteries,

Suggestion 2: He should twist the same number of coils.

41)a) 3 b) place the objects closer together.

c)Glass is transparent and will allow most light to pass through so the data logger cannot detect any blocks of the light.

42)a) Banana

b) Light travels in a straight line and will not pass through the other parts of the opaque cardboard.

c)i) The light was blocked by the toy dinosaur which was opaque.

42)c)ii) It would be smaller.

43)a) Line 1 : S line 2:T

b)T contain more water, thus it would require more heat energy and longer time to raise its temperature as shown by line 2 of the graph.

c) Some ice could have added to the breaker.

44)a The metal rod

b) The metal rod is a better conductor of heat than the plastic rod thus it would conduct heat from the boiling water to the wax faster.

