



RAFFLES GIRLS' PRIMARY SCHOOL

**SEMESTRAL ASSESSMENT 2
2015**

Your Score Out of 100 marks	
Parent's Signature	

Name : _____ ()

Banded Class: P4__

29th October 2015 MATHEMATICS Duration: 1 h 45 min

SECTION A (25 marks)

Question 1 to 5 carry 1 mark each. Question 6 to 15 carry 2 marks each. For each question, four options are given. One of them is the correct answer. All the diagrams are not drawn to scale.

Make your choice (1, 2, 3 or 4). Shade your answer (1, 2, 3 or 4) on the OAS provided.

1. In which of the following numbers does the digit 6 stand for 600?

(1) 6890

(2) 8906

(3) 8690

(4) 9860

2. $40\,000 + 2000 + 700 + 1 =$ _____

(1) 42 710

(2) 42 701

(3) 42 071

(4) 40 271

3. The area of a square is 144 cm^2 .
Find its length.

(1) 12 cm

(2) 24 cm

(3) 36 cm

(4) 72 cm

4. The opening hours of a shop are as shown below. How long is the shop open each day?

The Craft Shop
Open Daily
9.45 a.m to 4 p.m

- (1) 5 h 15 min
- (2) 5 h 45 min
- (3) 6 h 15 min
- (4) 6 h 45 min

5. The following graph shows the number of concert tickets purchased by a group of pupils. Study the graph carefully and answer the question that follows.

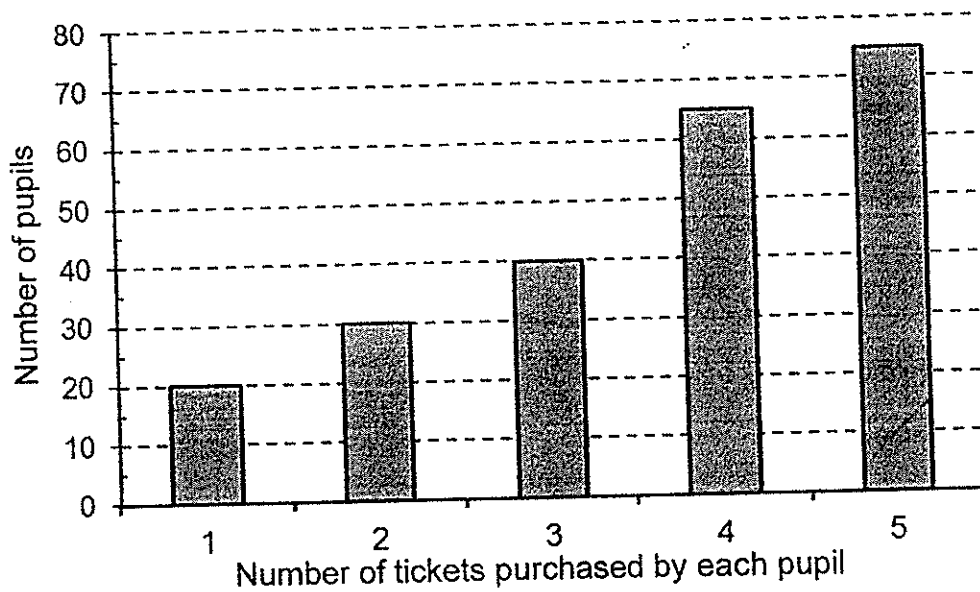

What is the total number of pupils who purchased more than 3 tickets?

- (1) 40
- (2) 50
- (3) 140
- (4) 180

6. Express $7\frac{3}{20}$ as a decimal.

- (1) 7.32
- (2) 7.3
- (3) 7.15
- (4) 7.015

7. Which of the following is an equivalent fraction of $\frac{1}{4}$?

- (1) $\frac{4}{12}$
- (2) $\frac{6}{16}$
- (3) $\frac{2}{8}$
- (4) $\frac{3}{4}$

8. The figure shown is made up of a square S of side 3 cm and a rectangle R with breadth 4 cm. What is the length of the rectangle?

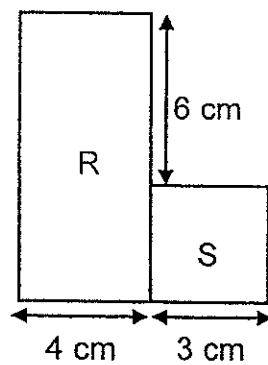

- (1) 6 cm
- (2) 7 cm
- (3) 9 cm
- (4) 10 cm

9. Which of the following mixed numbers is represented by letter A in the number line shown below?

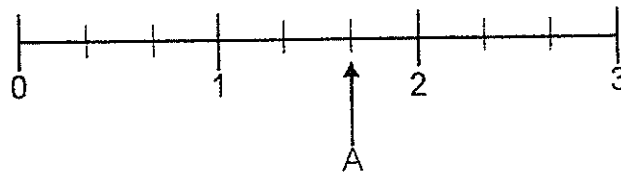

- (1) $1\frac{1}{2}$
- (2) $1\frac{1}{3}$
- (3) $1\frac{2}{3}$
- (4) $1\frac{1}{4}$
10. What is the number when 100.63 is rounded off to 1 decimal place?
- (1) 100.0
- (2) 100.6
- (3) 100.7
- (4) 101.0
11. Which of the numbers below is 100 more than 4378?
- (1) 4379
- (2) 4388
- (3) 4478
- (4) 5378
12. Siti bought 2 cakes and 2 buns at \$6.80. Each cake cost \$0.40 more than each bun.
What was the cost of one bun?
- (1) \$1.50
- (2) \$1.60
- (3) \$3.00
- (4) \$3.40

13. ABCD is a square made up of 2 squares and 2 rectangles. The squares have an area of 49 cm^2 and 16 cm^2 respectively.

Find the area of ABCD.

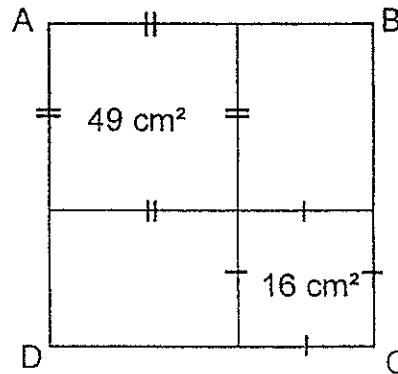

- (1) 65 cm^2
 (2) 121 cm^2
 (3) 130 cm^2
 (4) 260 cm^2
14. The table below shows the number of canned drinks sold during a softball carnival over three days.

Day	Pepsi	Coke	Total
Monday	123	140	263
Tuesday	308	425	733
Wednesday	?	?	432

The number of Coke sold on Wednesday is three times the number of Pepsi, how many cans of Coke were sold on Wednesday?

- (1) 108
 (2) 144
 (3) 234
 (4) 324
15. Jane bought 8 identical packets of juice. After she had used 5 packets of juice, she had 3450 ml of juice left. How many litres of juice did she buy?
- (1) 0.69 l
 (2) 1.15 l
 (3) 8.40 l
 (4) 9.20 l

SECTION B (40 marks)

Question 16 to 35 carry 2 marks each. Write your answers in the spaces provided. For questions which require units, give your answers in the units stated. All diagrams are not drawn to scale. Answers in fractions must be expressed in the simplest form. Marks will be awarded for relevant working.

16. Find the missing number in the number pattern below.

_____, 1045, 2045, 3045, 4045

Ans: _____

17. The figure below is made up of a rectangle and a square of side 7 cm.
Find the area of the shaded part.

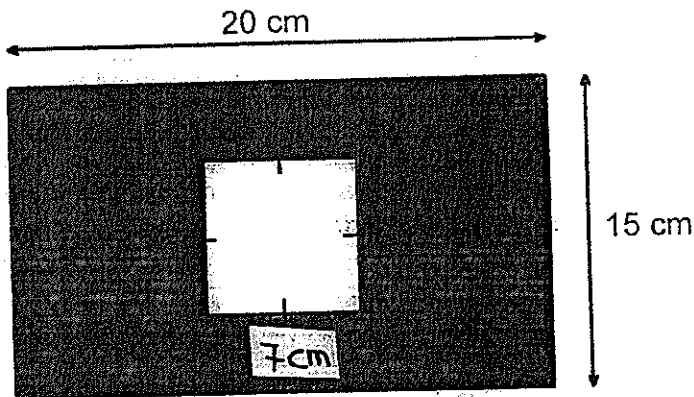

Ans: _____ cm²

18. The graph below shows the number of computers sold from January to April. The number of computers sold in May is two times the number of computers sold in February.

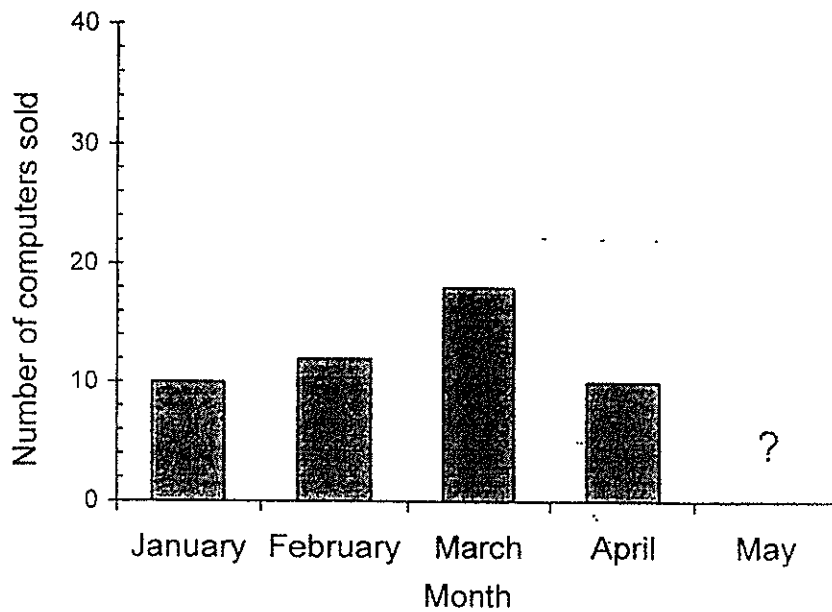

How many computers were sold in May?

Ans: _____

19. $0.7 = \frac{7}{\square}$

What is the missing number in the box?

Ans: _____

20. Draw the line of symmetry of the figure shown below.

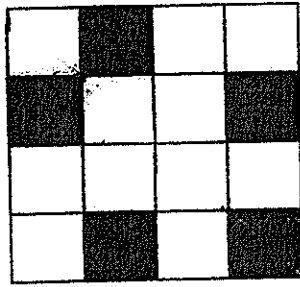

21. Shade the unit shape of tessellation for the figure below.

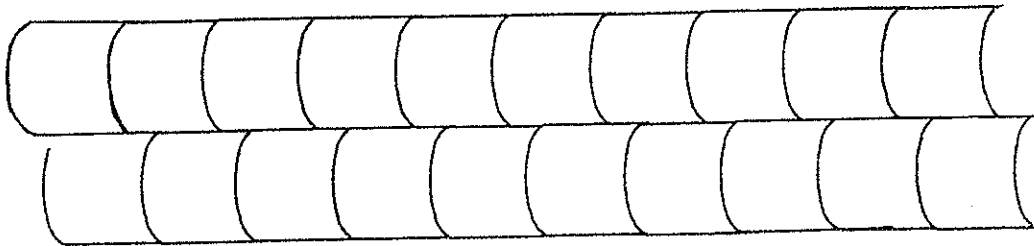

22. Which two of the fractions given below are bigger than $\frac{1}{2}$?

$$\frac{3}{9}, \frac{5}{8}, \frac{6}{12}, \frac{2}{3}$$

Ans: _____ and _____

23. Arrange the following numbers from the greatest to the smallest.

1.089, 0.31, 1.12, 0.032

Ans: _____, _____, _____, _____
Greatest Smallest

24. Complete the symmetric figure shown below with AB as the line of symmetry on the square grid.

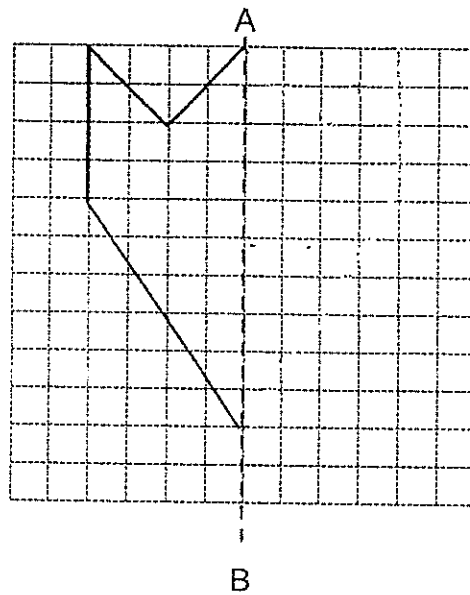

25. What is the value of $\frac{7}{8} + \frac{1}{4}$? Express your answer as a mixed number.

Ans: _____

26. Round off 24 537 to the nearest hundred.

Ans: _____

27. Some factors of 32 are 1, 2, 4 and 32. What are the other two factors of 32?

Ans: _____

28. Find the value of 4.63×7 .

Ans: _____

29. The table below shows the list of items in a P.E storeroom. One of the numbers was covered by ink.

Type of Item	Number of Items
Basketball	28
Bean bag	32
Tennis Ball	

$\frac{1}{5}$ of the total number of items in the P.E. store room are tennis balls.
How many tennis balls are there?

Ans: _____

30. Sue drove from Singapore to Penang in 12 hours 17 minutes. She reached Penang at 18 10 on Monday. What time did Sue start driving from Singapore? Express your answer in 24 hour clock.

Ans: _____

31. Measure $\angle a$.

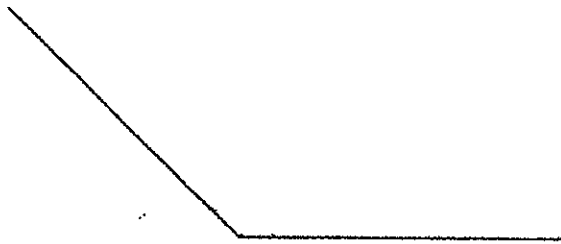

Ans: _____

- 32 Complete the tessellation below with 2 more units shape of tessellation.

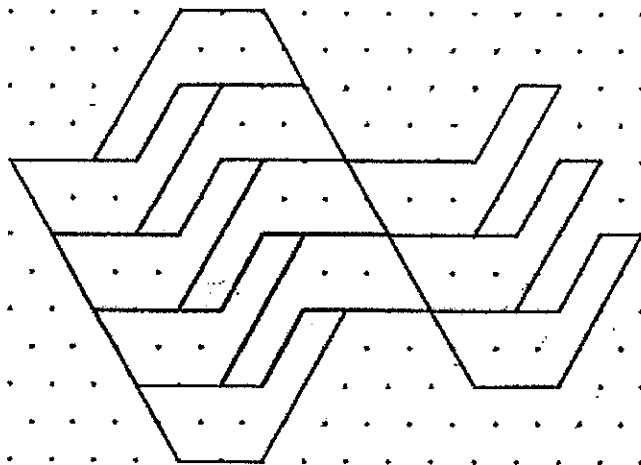

33. 8 identical chairs weigh 8576 g.
What is the mass of 1 chair?
Give your answer in kg.

Ans: _____ kg

34. Both number X and number Y when rounded off to nearest hundreds are 1200 and 5500 respectively.
What is the smallest possible total for X and Y?

Ans: _____

35. Lucy spent \$30 on 6 slices of cakes and 5 bottles of drink. She paid \$18 for all the cakes.
Each bottle of drink was of the same price.

What was the cost of a bottle of drink?

Ans: \$ _____

SECTION C (35 marks)

For question 36 to 44, show your working clearly in the space provided below each question and write your answer with suitable units in the spaces provided. All diagrams are not drawn to scale. Answers in fractions must be expressed in the simplest form. Marks will be awarded for relevant working. The number of marks available is shown in brackets [] at the end of each question or part-question.

36. Mr Lee bought some pens for his class of 40 pupils.
15 pupils received a total of 60 pens while the rest of the pupils received 3 pens each.
How many pens did Mr Lee buy?

Ans: _____ [3]

37. The line graph below shows the number of books borrowed from the library from January to May.

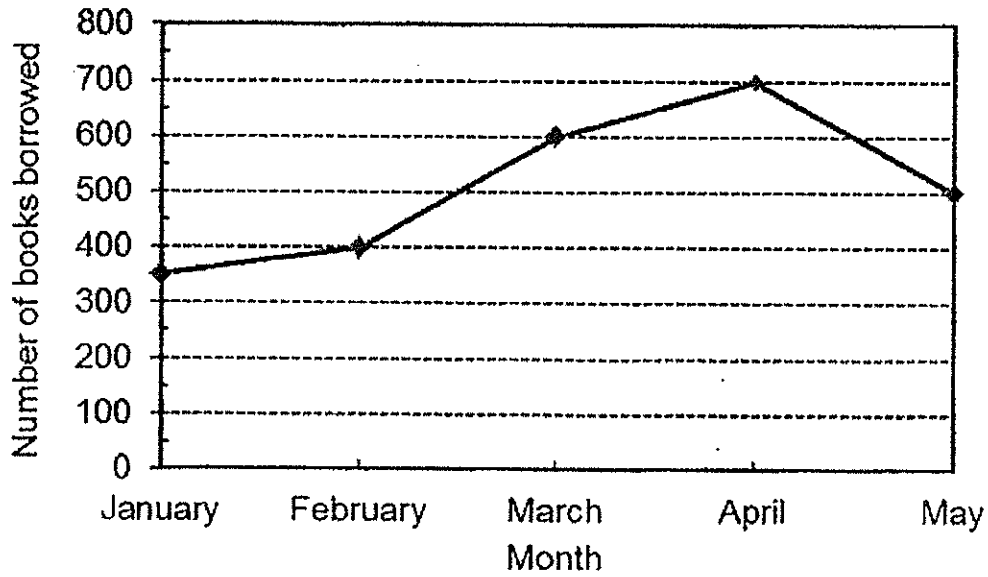

- a) Find the total number of books borrowed from January to May.
b) How many more books were borrowed in April than in January?

Ans: a) _____ [2]

b) _____ [1]

38. Josephine completed 4 jumps in the standing broad jump during NAPFA test.
The total distance covered in her jumps was 394.8 cm.
The distances covered for her first and second jumps were 97.7 cm and 98.9 cm.
The distances covered for her third and fourth jumps were the same.
What was the distance covered for the fourth jump?

Ans: _____ [4]

- 39 The figure below is made up of 4 identical rectangles, A, B, C and D.
The perimeter of rectangle A is 72 cm.
- (a) What is the breadth of rectangle B?
(b) Find the area of rectangle C.

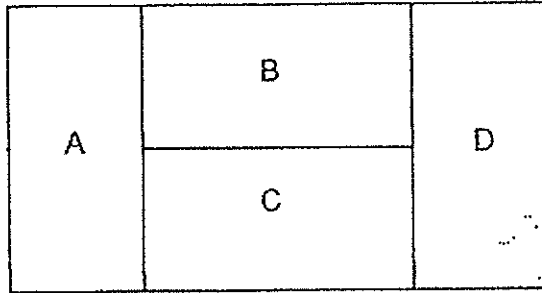

Ans a) _____ [2]

b) _____ [2]

40. Ming Huat had 255 watermelons and 240 oranges at first. He used $\frac{3}{5}$ of the watermelons and $\frac{3}{4}$ of the oranges. He then bought some more oranges. In the end, $\frac{1}{8}$ of the fruits he had left were watermelons. How many oranges did he buy?

Ans: _____ [4]

41. Study the pattern below. Each figure is made up of identical squares.

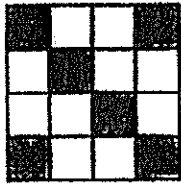

Figure 1

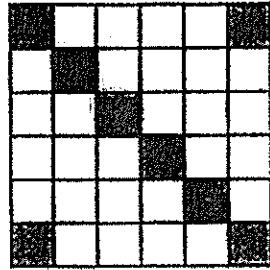

Figure 2

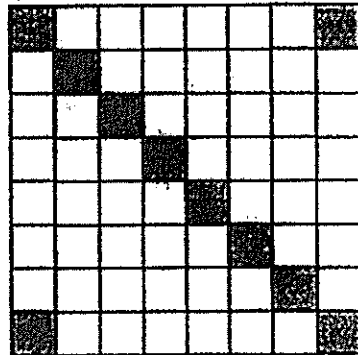

Figure 3

(a) What fraction of Figure 1 is shaded?

Express your answer in the simplest form.

(b) What is the number of shaded squares in Figure 4?

(c) What is the number of unshaded squares in Figure 8?

(a) _____ [1]

(b) _____ [1]

(c) _____ [3]

42. Chloe had \$150 more than Ann.
After Ann gave \$135 to Chloe, Chloe had 8 times as much money as Ann.
How much money did Chloe have at first?

Ans: _____ [4]

43. A container filled with 4 identical marbles weighs 1700g.
The same container when filled with 2 identical balls weighs 500g.
The mass of each marble is two times the mass of each ball.
What is the mass of the container?

Ans: _____ [4]

44. Da Hua Primary School took part in an inter-school games carnival and collected 116 medals altogether in 4 days.

On the second day, the school collected 6 more medals than the first day.

On the next two days, the school collected 6 more medals each day than the previous day.

How many medals did the school collect on the first day?

Ans: _____ [4]

-End of Paper-

Please check your work carefully ☺

Setters: Mr. Johnson Ong
Mrs. Bell

Ans

SCHOOL : RAFFLES GIRLS' PRIMARY SCHOOL
LEVEL : PRIMARY 4
SUBJECT : MATH
TERM : SA2

CONTACT : CALL MR GAN @ 9299 8971, 8606 5443, 9247 5053

SECTION A

Q 1	Q2	Q3	Q4	Q5	Q6	Q7	Q8	Q9	Q10
3	2	1	3	3	3	3	3	3	2

Q 11	Q12	Q13	Q14	Q15	Q16	Q17	Q18	Q19	Q20
3	1	2	4	4					

SECTION B

Q 16	Q17	Q18	Q19	
45	251	24	10	

Q20)

Q 21	Q22	Q23
{Just shade one of the shape}	$\frac{2}{3}$ and $\frac{5}{8}$	1.12, 1.089, 0.31, 0.032

Q24)

Q 25	Q26	Q27	Q28	Q29	Q30
$1\frac{1}{8}$	24 500	8 and 16	32.41	15	05 53

Q31)	135°
------	------

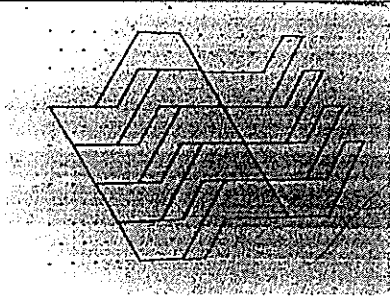
Q32)	
Q33)	$8576 \div 8 = \underline{1.072}$
Q34)	$X \rightarrow 1150$ $Y \rightarrow 5450$ $X + Y \rightarrow 1150 + 5450 = \underline{6600}$
Q35)	$30 - 18 = 12$ $12 \div 5 = \underline{2.40}$

SECTION C

Q36)	$40 - 15 = 25$ $25 \times 3 = 75$ $75 + 60 = \underline{135}$
Q37)	a) $350 + 400 + 600 = 1350$ $1350 + 700 = 2050$ $2050 + 500 = \underline{2550}$ b) $700 - 350 = \underline{350}$
Q38)	$97.7 + 98.9 = 196.6$ $394.8 - 196.6 = 198.2$ $198.2 \div 2 = 99.1$ Ans : <u>99.1 cm</u>

Q39)

a) $72 \text{ cm} \div 6 = \underline{12 \text{ cm}}$

b) $12 \text{ cm} + 12 \text{ cm} = 24 \text{ cm}$

$24 \text{ cm} \times 12 \text{ cm} = \underline{288 \text{ cm}^2}$

Q40)

$1 - \frac{3}{5} = \frac{2}{5}$

$255 \div 5 = 51$

W left $\rightarrow 51 \times 2 = 102$

$1 - \frac{3}{4} = \frac{1}{4}$

O left $\rightarrow 240 \div 4 = 60$

$102 \times 7 = 714$

$714 - 60 = \underline{654}$

Q41)

a) $4 \times 4 = 16$

$6/16 = \underline{3/8}$

b) $4 \times 2 = 8$

$8 + 4 = \underline{12}$

c) $8 \times 2 = 16$

$16 + 4 = 20$

X 2 :	2	4	6	8	10	12	14	16
Pattern Number :	1	2	3	4	5	6	7	8

$18 \times 18 = 324$

$324 - 20 = \underline{304}$

Q42)

Before

C		\$150
A		

After

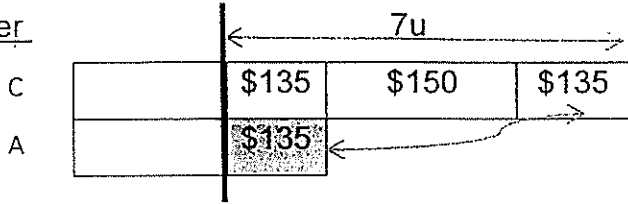

$$150 + 135 + 135 = 420$$

$$7u \rightarrow \$420$$

$$1u \rightarrow \$420 \div 7 = 60$$

$$C \text{ at first} \rightarrow 60 + \$135 + \$150 = \underline{\$345}$$

Q43)

$$1700 - 500 = 1200$$

$$4 - 1 = 3$$

$$1200 \div 3$$

$$400 \times 4 = 1600$$

$$1700 - 1600 = \underline{100}$$

Q44)

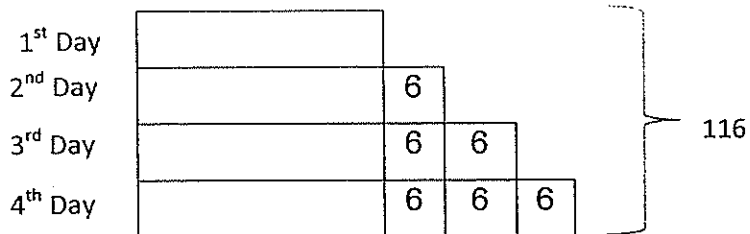

$$6 \times 2 = 12$$

$$6 \times 3 = 18$$

$$18 + 12 + 6 = 36$$

$$116 - 36 = 80$$

$$80 \div 4 = \underline{20}$$

