

NANYANG PRIMARY SCHOOL

**SECOND SEMESTRAL EXAMINATION
2015**

PRIMARY 4

MATHEMATICS

DURATION: 1 HOUR 45 MINUTES

Section A	/ 30
Section B	/ 40
Section C	/ 30

Total:	/ 100
---------------	--------------

Name: _____ ()

Class: Primary 4 ()

Date: 26 October 2015

Any query on marks awarded should be raised by **06 November 2015**.
We seek your understanding in this matter as any delay in the
confirmation of marks will lead to delays in the generation of results.

Parent's Signature: _____

**DO NOT OPEN THIS BOOKLET UNTIL YOU ARE TOLD
TO DO SO.**

**FOLLOW ALL INSTRUCTIONS CAREFULLY.
ANSWER ALL QUESTIONS.**

Section A

Questions 1 to 15 carry 2 marks each. For each question, four options are given. One of them is the correct answer. Make your choice (1, 2, 3 or 4). Shade the oval (1, 2, 3 or 4) on the Optical Answer Sheet.

(Total: 30 marks)

1. 25 thousands and 9 tens is the same as _____.

- (1) 259
- (3) 25 009

- (2) 2590
- (4) 25 090

2. Complete the following number pattern.

5, 12, 19, _____, _____, 40

- (1) 20, 21
- (3) 26, 27

- (2) 20, 39
- (4) 26, 33

3. Which one of the following numbers when rounded off to the nearest ten becomes 39 800?

- (1) 39 749
- (3) 39 804

- (2) 39 794
- (4) 39 853

4. What fraction of the shapes in the box are  ?

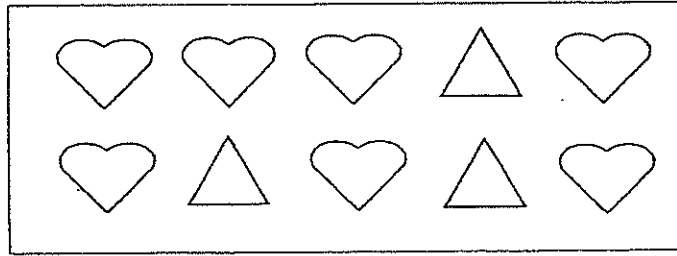

(1) $\frac{3}{7}$

(2) $\frac{7}{3}$

(3) $\frac{3}{10}$

(4) $\frac{7}{10}$

5. Which one of the following letters has perpendicular lines?

(1) **A**

(2) **F**

(3) **M**

(4) **W**

6. Round off 73.85 to the nearest whole number.

(1) 70

(2) 73

(3) 74

(4) 75

7. Study the clock faces below.

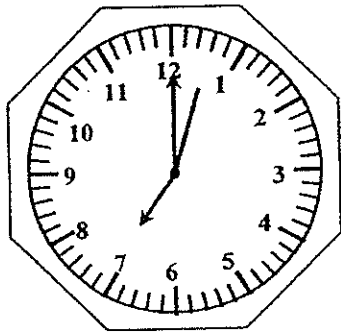

Starting

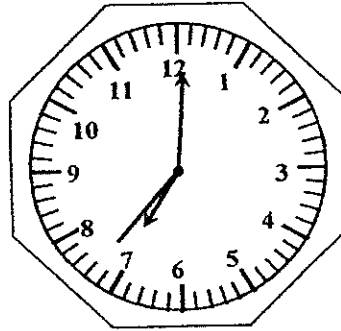

Ending

Find the duration of the starting time and the ending time.

- (1) 37 s
- (3) 3 s

- (2) 34 s
- (4) 12 s

8. Study the figure below. All the sides of the triangle and the five-sided figure are equal. Which is the correct line of symmetry?

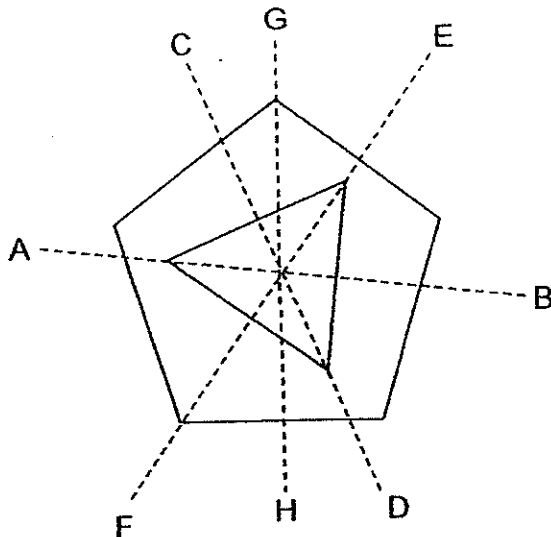

- (1) AB
- (3) EF

- (2) CD
- (4) GH

9. The pattern below shows part of a tessellation formed by using only one unit shape.

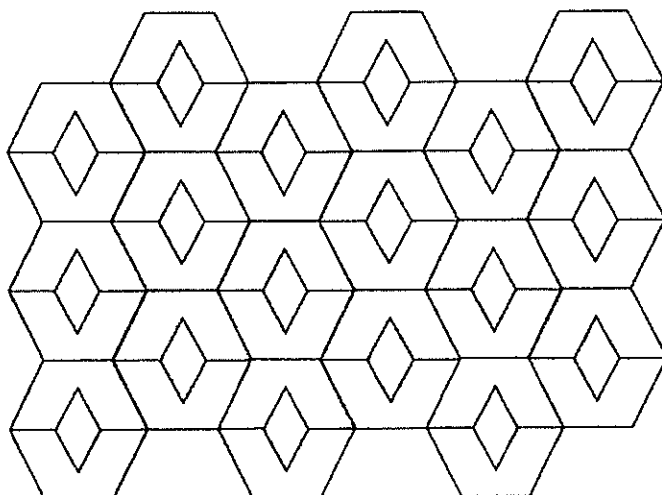

Which one of the following is the unit shape used in the tessellation above?

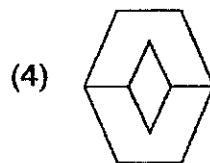
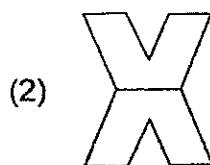
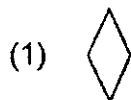

10. Yuri used the unit shape  to form 4 different tessellations.

Which one of the following shows the correct tessellation?

(1)

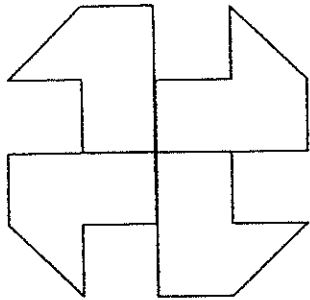

(2)

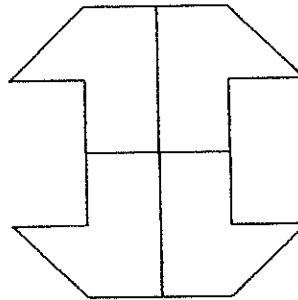

(3)

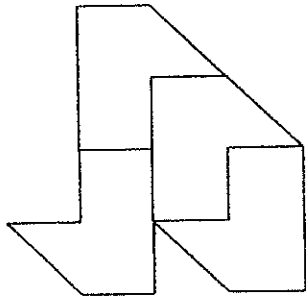

(4)

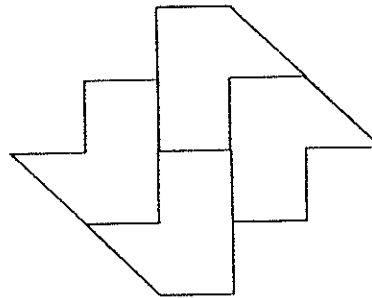

11. Kyan collected 5159 stamps last year. This year, he collected twice as many stamps as last year. Find the number of stamps he collected this year. Round off your answer to the nearest thousand.

- (1) 10 000
(3) 10 318

- (2) 10 300
(4) 11 000

12. Candy is 1.14 m tall. Alan is 0.23 m taller than Candy. What is the total height of the 2 children? Round off your answer to 1 decimal place.

- (1) 1.4 m
- (2) 2.1 m
- (3) 2.5 m
- (4) 2.6 m

13. ABCD is a square and CEFG is a rectangle. Find $\angle x + \angle y$.

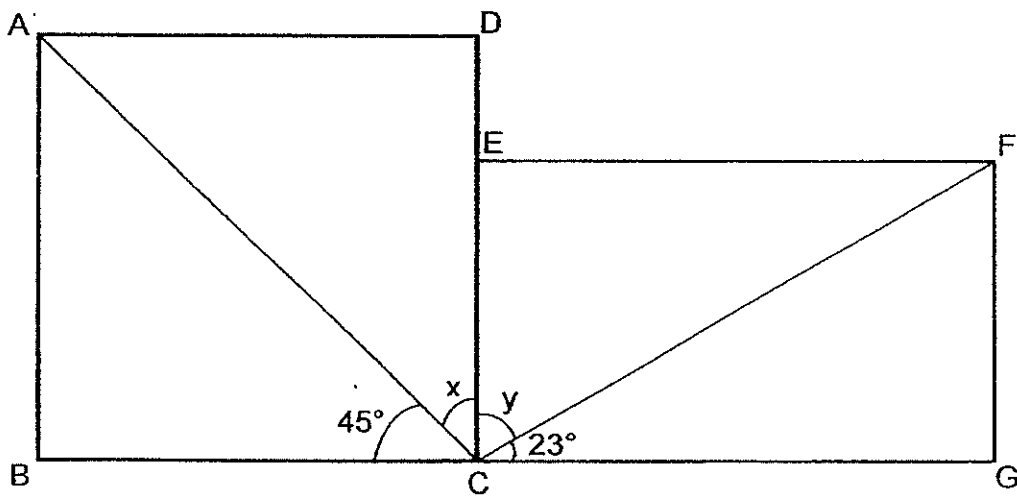

- (1) 45°
- (2) 67°
- (3) 112°
- (4) 135°

14. The mass of Wei Liang is $\frac{3}{2}$ of Ahmad's mass. Ahmad's mass is 36 kg. John is 14 kg lighter than Wei Liang. What is the mass of John?

- (1) 10 kg (2) 38 kg
(3) 40 kg (4) 68 kg

15. Bertrand is watching an orchestral performance in a concert hall. There are 25 seats to his right and 30 seats to his left. There are 48 rows of seats in front of him and 56 rows behind him. There are an equal number of seats in each row. What is the total number of seats in the concert hall?

- (1) 750 (2) 2688
(3) 5720 (4) 5880

Section B

Questions 16 to 35 carry 2 marks each. Show your working clearly in the space below each question and write your answers in the spaces provided. For questions which require units, give your answers in the units stated.

(Total: 40 marks)

16. Two factors of 95 are 1 and 95. What are the other two factors of 95?

Ans : _____ , _____

17. $\frac{1}{3} + \frac{5}{9} =$ _____

Ans : _____

18. Find the value of $1 - \frac{1}{8} - \frac{3}{4}$.

Ans : _____

19. Which two of the fractions below are smaller than $\frac{1}{2}$?

$\frac{1}{4}$, $\frac{2}{3}$, $\frac{3}{7}$, $\frac{4}{5}$

Ans : _____ , _____

20. In the figure, name the two angles that are greater than 90° .

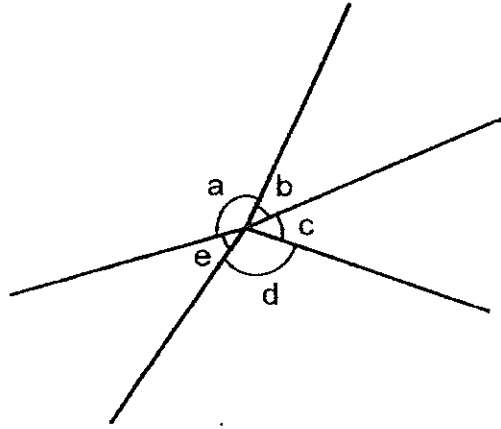

Ans : \angle _____ , \angle _____

21. Express $\frac{7}{100}$ as a decimal.

Ans : _____

22. Write the decimal represented by A.

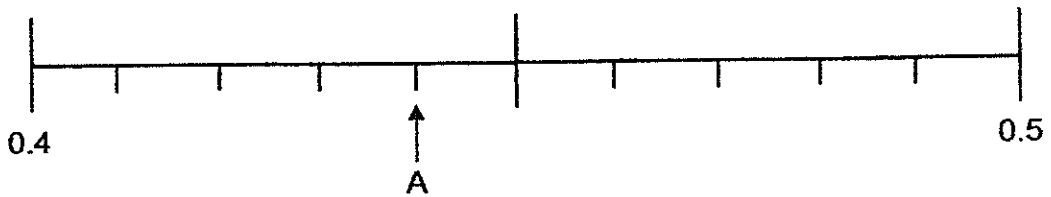

Ans : _____

23. Arrange the following numbers in order from the greatest to the smallest.

0.075 , 0.705 , 0.507

Ans: _____ , _____ , _____
(greatest) (smallest)

24. Find the value of 3.84×7 .

Ans : _____

25. Find the difference between 20 tenths and 35 hundredths. Leave your answer as a mixed number in its simplest form.

Ans : _____

26. Amelia won \$3888 in a lucky draw. She shared her winnings with her two parents. Each of her parents received 4 times as much money as Amelia. How much money did Amelia keep for herself?

Ans : \$ _____

27. There are three numbers. The first number is $\frac{5}{12}$ of the second number. The second number is $\frac{4}{9}$ of the third number. The third number is 189. Find the first number.

Ans : _____

28. Draw a straight line such that $\angle XYZ = 153^\circ$ and the line passes through the line VW . Mark and label $\angle XYZ$.

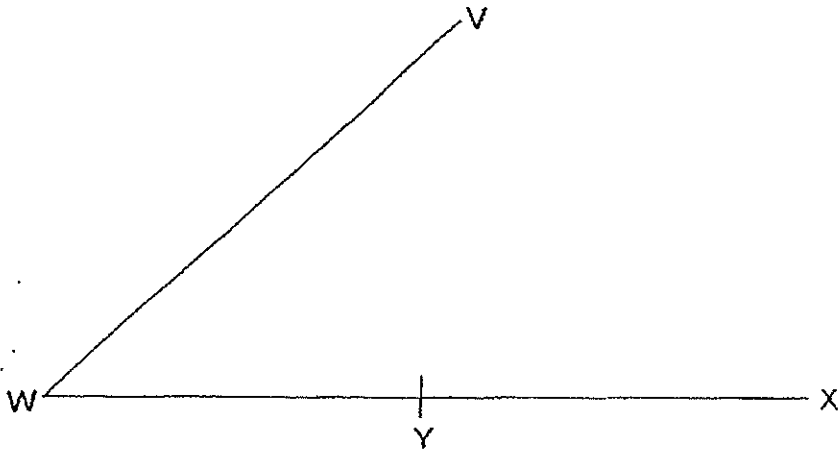

29. In the figure below, ABC is a triangle. Draw a line that is perpendicular to AB passing through point C . Mark the point where this line meets AB as D .

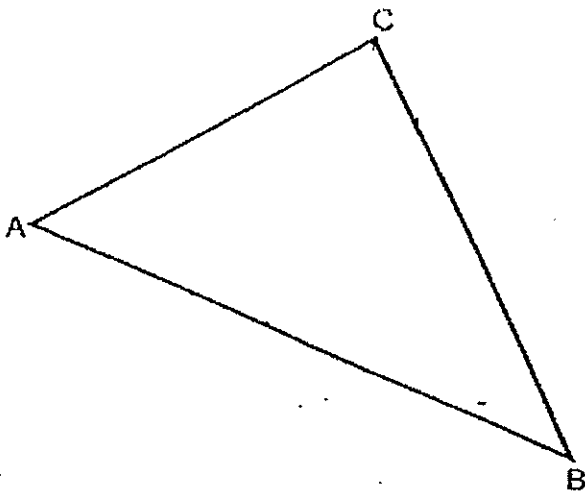

30. Melissa had a piece of ribbon as shown below. She cut part of it and the piece of ribbon became shorter by 5.5 cm. What was the length of the ribbon that was left?

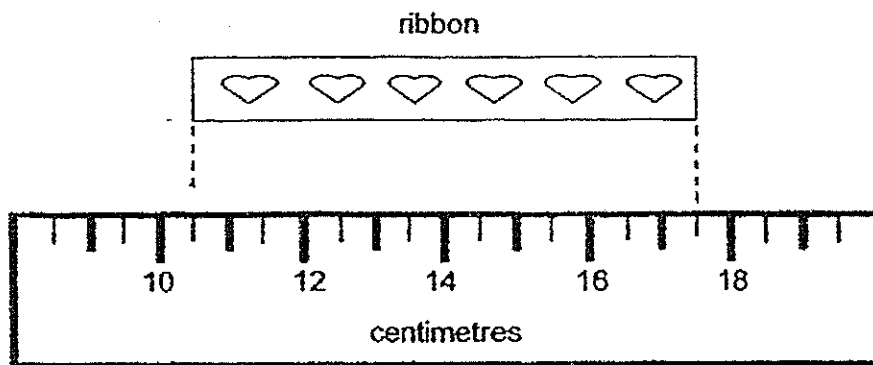

Ans : _____ cm

31. At a shop, packets of sugar were sold at 3 for \$3.90. Mrs Toh bought 5 such packets. How much did Mrs Toh pay?

Ans : \$ _____

32. Complete the symmetric figure below. PQ is the line of symmetry.

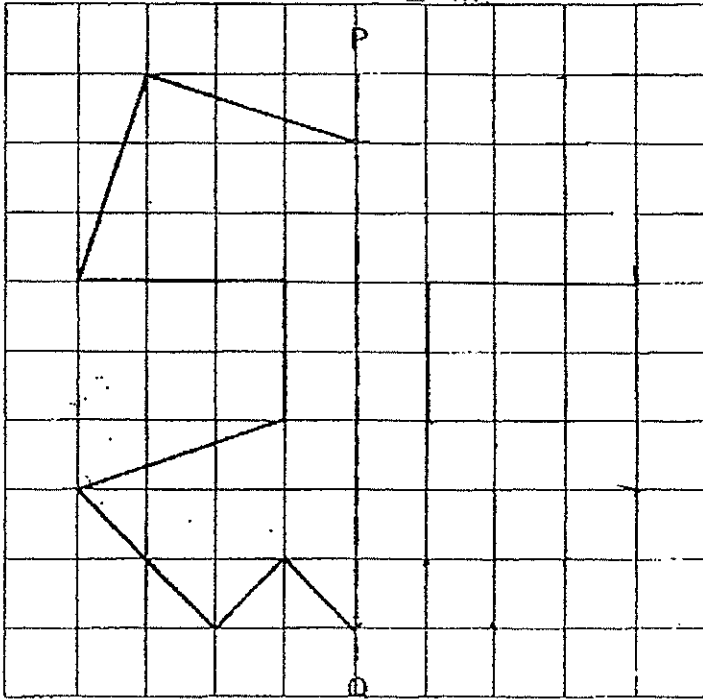

33. The pattern in the box below shows part of a tessellation. Extend the tessellation by drawing two more unit shapes in the space provided in the box.

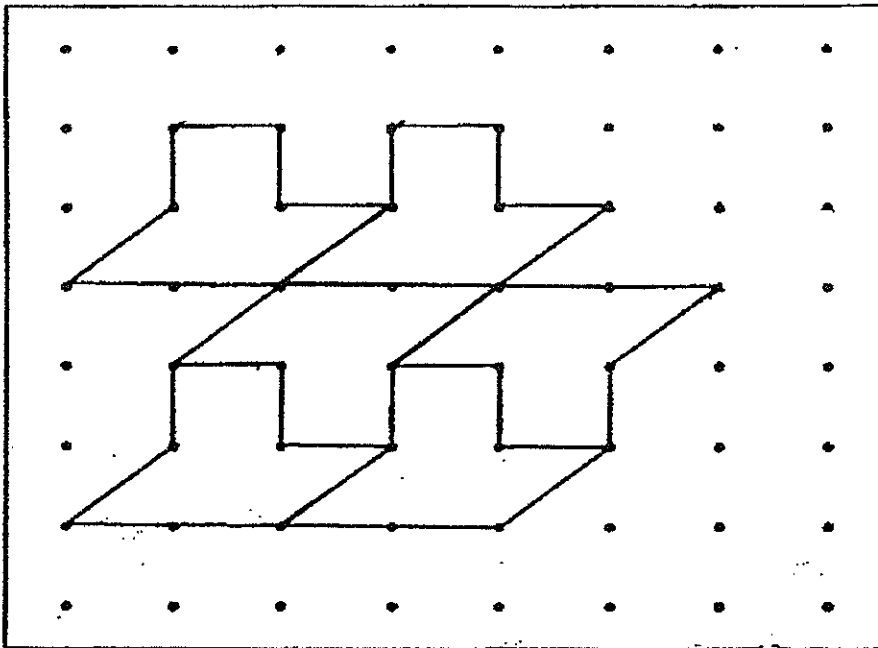

34. The table below shows the number of teachers and pupils who went to Snow City. A total of 220 teachers and pupils went to Snow City. 198 of them are pupils.

Complete the following table by writing the correct answers on the lines provided.

	Male	Female
Number of Teachers	10	c) _____
Number of Pupils	a) _____	84
Total	b) _____	d) _____

35. The figure below is made up of a square and a rectangle. The side of the square is 9 cm. The perimeter of the figure is 108 cm. What is the length of the rectangle?

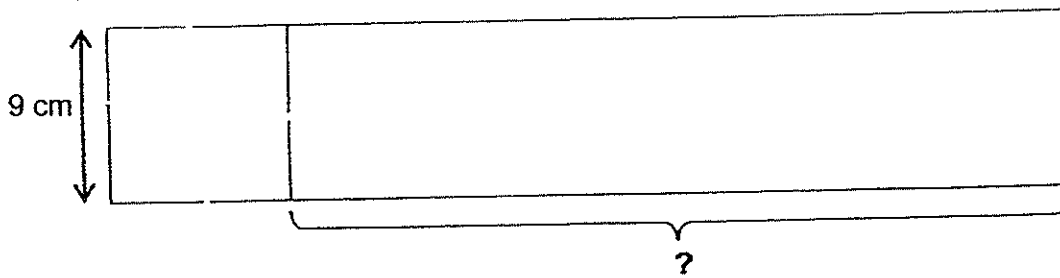

Ans : _____ cm

Section C

Questions 36 to 37 carry 3 marks each and questions 38 to 43 carry 4 marks each. Do these word problems carefully. Show your working clearly in the space provided for each question and write your answers in the spaces provided.

(Total: 30 marks)

36. Mrs Seah has some erasers. The number of erases that she has is between 50 to 80. When she packs 7 erasers into each pack, she has 6 extra erasers. When she packs 8 erasers into each pack, she is short of 4 erasers. How many erasers does Mrs Seah have?

Ans: _____ [3]

37. Arif paid \$279.30 for 2 pairs of pants and 3 shirts. Each pair of pants cost twice as much as each shirt. How much did each pair of pants cost?

Ans: _____ [3]

38. When a number is divided by 12, the quotient is 74. Add 234 to the same number and divide the sum by 6. What is the new quotient?

Ans: _____ [4]

39. A car-wash machine takes $\frac{1}{6}$ h to wash 1 car. Washing the car by hand takes $\frac{1}{4}$ h longer than the car-wash machine.

- (a) Find the time taken to wash 1 car by hand.
- (b) Find the total time taken to wash 3 cars by hand. Leave your answer in hours and minutes.

Ans: (a) _____ [2]

(b) _____ [2]

40. Fadil has a rectangular piece of paper measuring 42 cm by 20 cm as shown in Figure 1. He cuts out a square from the paper and shifts it to the side of the remaining piece of paper to create a new figure as shown in Figure 2. There is no overlapping of the 2 pieces of paper. Figure 2 has a perimeter of 168 cm. What is the area of the square that was cut out?

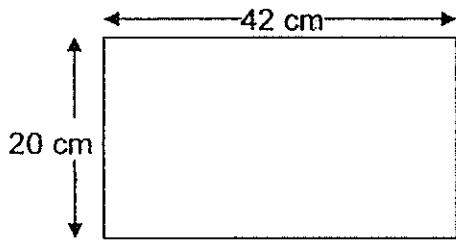

Figure 1

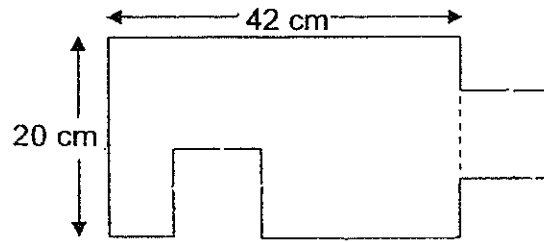

Figure 2

Ans: _____ [4]

41. A businessman took a flight at 01 10 on Tuesday to fly from Singapore to Italy. The time in Singapore is 6 hours ahead of the time in Italy.

(a) What was the local time in Italy when the flight left Singapore?

(b) The flight lasted 12 h 55 min. What was the time in Singapore when he reached Italy?

Ans: (a) _____ [2]

(b) _____ [2]

42. An ice cream shop owner kept a record of the number of ice cream cones he sold from Wednesday to Sunday. He then plotted a line graph based on the data.

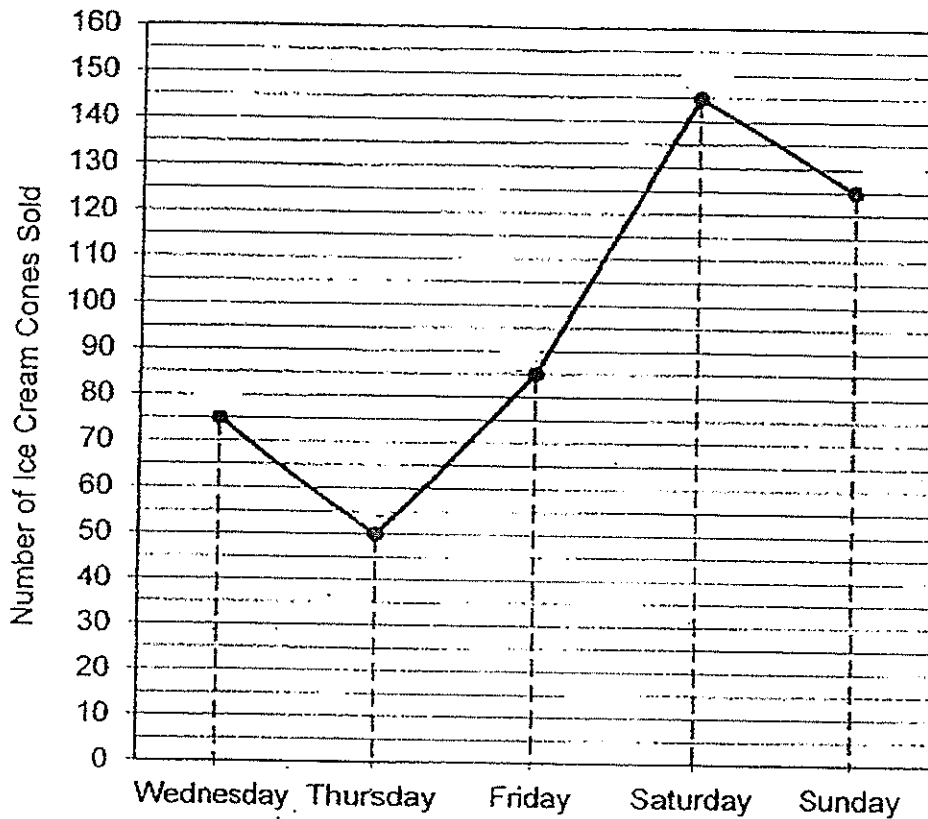

- (a) Which day did he sell the greatest number of ice cream cones?

Ans : _____ [1]

- (b) What was the difference in the number of ice cream cones sold between Wednesday and Thursday?

Ans : _____ [1]

- (c) He sold his ice cream cones at \$2 each. How much did he collect from the sale of the ice cream cones from Friday to Sunday?

Ans : _____ [2]

43. Jia Xian attempted all the 15 questions in a quiz and scored 10 marks. Given that 3 marks were awarded for each correct answer but 2 marks were deducted for each wrong answer. how many questions did Jia Xian answer correctly?

Ans: _____

END OF PAPER

EXAM PAPER 2015**LEVEL : PRIMARY 4****SCHOOL : NANYANG PRIMARY SCHOOL****SUBJECT : MATHEMATICS****TERM : SA2**

Q1	Q2	Q3	Q4	Q5	Q6	Q7	Q8	Q9	Q10
4	4	3	3	2	3	2	3	4	4
Q11	Q12	Q13	Q14	Q15					
1	3	3	3	4					

Q16. 5, 19

Q17. $\frac{8}{9}$ Q18. $\frac{1}{8} \frac{1}{8} + \frac{6}{8} = \frac{7}{8}, 1 - \frac{7}{8} = \frac{1}{8}$ Q19. $\frac{1}{4}, \frac{3}{7}$ Q20. $\angle a, \angle d$

Q21. 0.07

Q22. 0.44

Q23. $0.705 \cdot 0.507, 0.075$ Q24. $26.88 \rightarrow 3.84 \times 7 = 26.88$ Q25. $1\frac{13}{20} \rightarrow \frac{20}{10} - \frac{35}{100} = 2 - 0.35 = 1.65 = 1\frac{65}{100} = 1\frac{13}{20}$ Q26. $\$432 \rightarrow 3888 \div 9 = 432$ Q27. 35 second no. $\rightarrow 189 \div 9 = 21, 21 \times 4 = 84, \text{first no. } 84 \div 12 = 7, 7 \times 5 = 35$

Q28. SEE PICTURE

Q29. SEE PICTURE

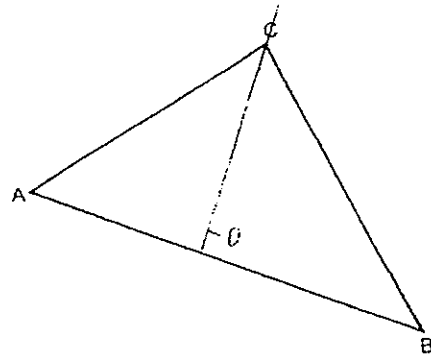
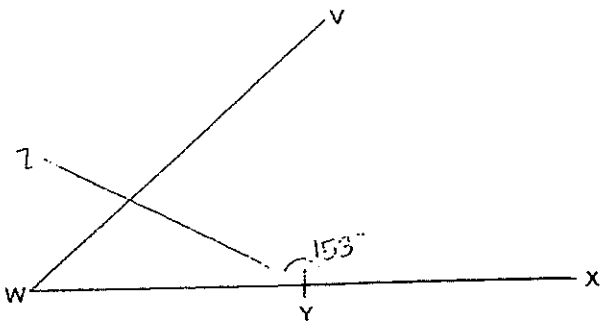
Q30. $1.5\text{cm} \rightarrow 17.5 - 10.5 = 7.0, 7.0 - 5.5 = 1.5$ Q31. $\$6.50 \rightarrow 3.90 \div 3 = 1.30, 1.30 \times 5 = 6.50$

Q32. SEE PICTURE

Q33. SEE PICTURE

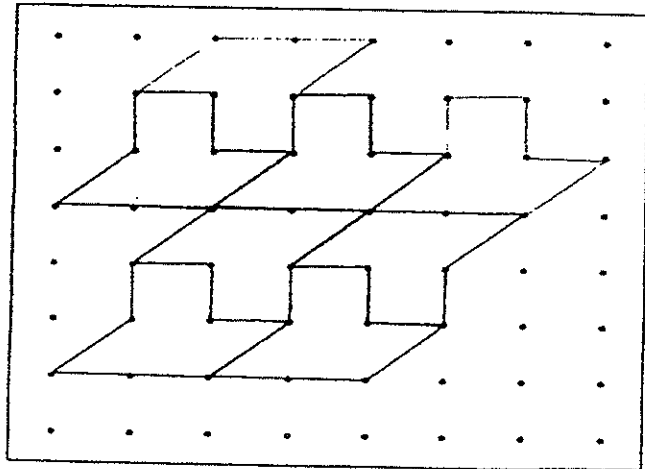
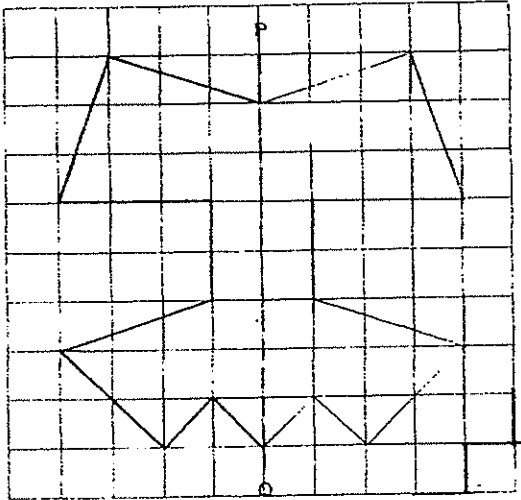

Q34a. 114 Q34b. 124 Q34c. 12 Q34d. 96

Q35. $36\text{cm} \rightarrow 9 \times 4 = 36, 108 - 36 = 72, 72 \div 2 = 36$ Q36. $76 \rightarrow 10 \times 7 = 70, 70 + 6 = 76, 10 \times 8 = 80, 80 - 4 = 76$

Q37. $\$79.80 \rightarrow 279.30 \div 7 = 39.90, 39.90 \times 2 = 79.80$

Q38. $187 \rightarrow 74 \times 12 = 888, 888 + 234 = 1122, 1122 \div 6 = 187$

Q39a. 25min

Q39b. 1h 15min

$$\frac{2}{12} + \frac{3}{12} = \frac{5}{12}$$

$$25 \times 3 = 75$$

Q40. 121cm^2

$$(42 + 20) \times 2 = 62 \times 2 = 124,$$

$$168 \rightarrow 124 + X \text{ (side)} + X + X + X$$

$$168 - 124 = 44, 44 \div 4 = 11 \text{ (one side of square)}, 11 \times 11 = 121$$

Q41a. 1910

Q41b. 1405

Q42a. Saturday

Q42b. $25 \times 75 - 50 = 25$

Q42c. $\$710 \rightarrow 85 + 145 + 125 = 355, 355 \times 2 = 710$

Q43. 8 If all questions are correct, $15 \times 3 = 45\text{m}$

1 question wrong, lose 3m & deduct 2m, total (-5m)

He scored 10m means he lost 35m, $45\text{m} - 10\text{m} = 35\text{m}$ $35 \div 5 = 7$

He had 7 questions wrong. He had 8 questions correct.

THE END