

# METHODIST GIRLS' SCHOOL (PRIMARY)

Founded in 1887



## END-OF-YEAR EXAMINATION 2015 PRIMARY 4 MATHEMATICS BOOKLET A

Total Time: 1 h 45 minutes

### INSTRUCTIONS TO CANDIDATES

Do not turn over this page until you are told to do so.  
Follow all instructions carefully.  
Answer all questions.

Name: \_\_\_\_\_ ( )

Class: Primary 4. \_\_\_\_\_

Date: 28 OCTOBER 2015

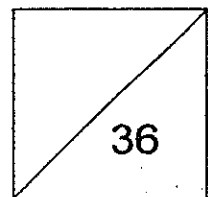

This booklet consists of 7 printed pages including this page.

**Section A: MCQ (36 marks)**

Questions 1 to 18 carry 2 marks each. For each question, four options are given. One of them is the correct answer. Make your choice (1, 2, 3 or 4). Shade the correct oval (1, 2, 3 or 4) on the Optical Answer Sheet.

1. In which of the following numbers does the digit 6 stand for 600?

- (1) 5806
- (2) 5860
- (3) 8605
- (4) 8065

2. Which of the following numbers when rounded off to the nearest hundred becomes 25 000?

- (1) 24 444
- (2) 24 996
- (3) 25 546
- (4) 25 594

3.  $\frac{1}{4} + \frac{1}{12} = \square$

What is the fraction in the box?

- (1)  $\frac{2}{4}$
- (2)  $\frac{4}{12}$
- (3)  $\frac{2}{16}$
- (4)  $\frac{1}{48}$

(Go on to the next page)

4. Which of the following fractions is in its simplest form?

(1)  $\frac{2}{8}$

(2)  $\frac{3}{9}$

(3)  $\frac{4}{7}$

(4)  $\frac{5}{10}$

5. What is the number when 143.54 is rounded off to 1 decimal place?

(1) 143.0

(2) 143.5

(3) 143.6

(4) 144.0

6. Write  $7\frac{4}{25}$  as a decimal.

(1) 7.4

(2) 7.25

(3) 7.16

(4) 7.016

7.  $0.7 + \frac{8}{1000} + \boxed{\phantom{000}} = 0.768$

What is the missing number in the box?

(1) 0.006

(2) 0.06

(3) 0.6

(4) 6.0

8. Jane has 3.15 kg of flour. She wants to pack the flour equally into 3 packets. How much flour should be put in each packet?

- (1) 1.01 kg
- (2) 1.03 kg
- (3) 1.05 kg
- (4) 1.50 kg

Study the graph carefully and answer questions 9 and 10.

The graph below shows the amount of petrol used by Mr Tan in 5 days.

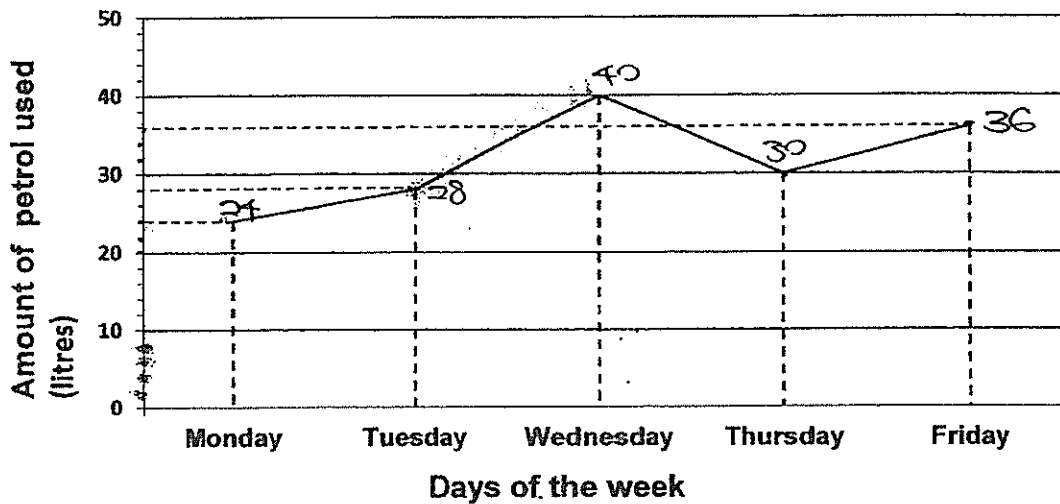

9. Between which 2 days was the difference in the amount of petrol used the greatest?
- (1) Monday and Tuesday
  - (2) Thursday and Friday
  - (3) Tuesday and Wednesday
  - (4) Wednesday and Thursday
10. Petrol was sold at \$2 per litre. What was the total amount of money spent on petrol by Mr Tan for the 5 days?
- (1) \$ 158
  - (2) \$ 244
  - (3) \$ 308
  - (4) \$ 316

11. Jennifer completed doing her homework at 13 30. She took 2 h 10 min to do her homework. At what time did she start doing her work?

- (1) 10 50
- (2) 11 20
- (3) 15 30
- (4) 15 40

12. Which of the following shapes contains both parallel and perpendicular lines?

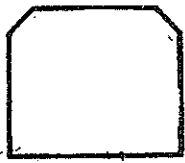

(1)

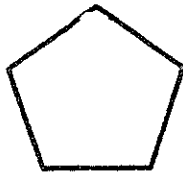

(2)



(3)

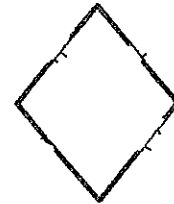

(4)

13. After making a  $135^\circ$  turn clockwise, Raju found himself facing North-east. In which direction was Raju facing at first?

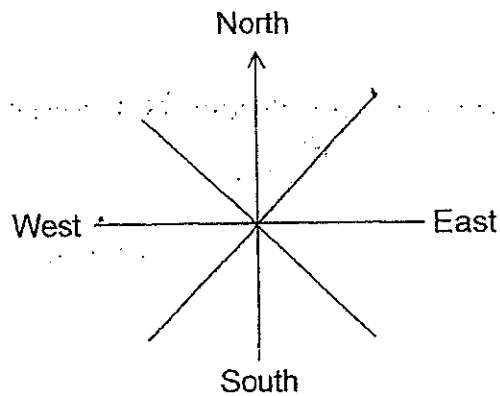

- (1) North
- (2) South
- (3) East
- (4) West

- 14 Mrs Lim, the choir mistress, sent 68 choir uniforms for dry cleaning. It cost \$18 to dry clean each uniform. What was the total cost of dry cleaning all the choir uniforms?

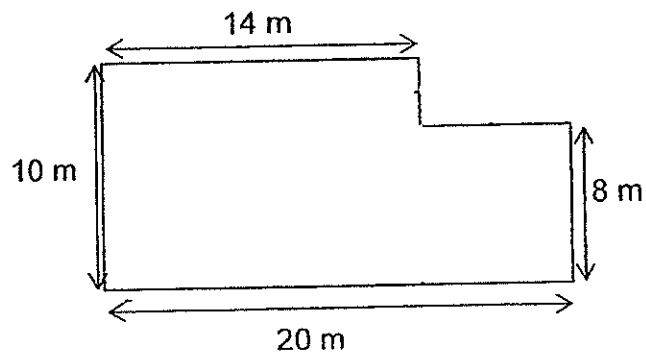

- (1) \$612  
 (2) \$1124  
 (3) \$1164  
 (4) \$1224

15. A fence is placed around a plot of land as shown below. What is the perimeter of the plot of land?

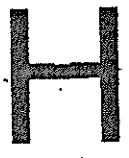

- (1) 52 m  
 (2) 54 m  
 (3) 58 m  
 (4) 60 m

16. Which of the following figures has 2 lines of symmetry?

			
(1)	(2)	(3)	(4)

- 17 Gopal is thinking of a number. The number is divisible by 6 and 8.  
What is the number?

- (1) 96  
(2) 84  
(3) 64  
(4) 56

- 18 The table below shows the admission charges to River Safari.

Admission Tickets	
Adult	\$28
Child	\$18

To encourage family outings, grandparents only need to pay half the price of an adult ticket.

Grandma Lim took her 2 young grandchildren to the River Safari on Children's Day. What was the total cost of their admission tickets?

- (1) \$32  
(2) \$46  
(3) \$50  
(4) \$64





# METHODIST GIRLS' SCHOOL (PRIMARY)

Founded in 1887



## END-OF-YEAR EXAMINATION 2015 PRIMARY 4 MATHEMATICS BOOKLET B

Total Time: 1 h 45 minutes

### INSTRUCTIONS TO CANDIDATES

Do not turn over this page until you are told to do so.  
Follow all instructions carefully.  
Answer all questions.

Name: \_\_\_\_\_ ( )

Class: Primary 4. \_\_\_\_\_

Date: 28 OCTOBER 2015

PARENT'S SIGNATURE:

BOOKLET A	36
BOOKLET B	36
BOOKLET C	28
TOTAL	100

This booklet consists of 6 printed pages including this page.

**Section B: (36 marks)****Questions 19 to 36 carry 2 marks each.****Write out the correct answers for the following questions in the space provided. Show your working clearly and give your answers in the units provided.**

19. Write the missing number in the number pattern below.

40 850 , 40 300 , 39 750 , \_\_\_\_\_ , 38 650, 38 100

Ans : \_\_\_\_\_

20. Some factors of 56 are 1, 2, 7, 8, 28 and 56. What are the other two factors of 56?

Ans : \_\_\_\_\_

21. What is the remainder when 4 374 is divided by 7?

Ans : \_\_\_\_\_

22. Which two of the fractions below are greater than  $\frac{1}{2}$  ?

$$\frac{3}{6}, \frac{4}{9}, \frac{5}{7}, \frac{6}{11}$$

Ans : \_\_\_\_\_

23. Write  $\frac{18}{4}$  as a mixed number in its simplest form.

Ans : \_\_\_\_\_

(Go on to the next page)

24. Arrange the following numbers from the smallest to the greatest.

$$\frac{3}{20}, 0.015, 0.105$$

\_\_\_\_\_ , \_\_\_\_\_ , \_\_\_\_\_  
 (smallest) , , (greatest)

25  $10.5 - 0.76 =$  \_\_\_\_\_

Ans : \_\_\_\_\_

26. At a stationery shop, pens were sold at 2 for \$3.60. Mrs Tan bought 12 such pens. How much did she pay?

Ans : \_\_\_\_\_

27. Measure and write down the size of  $\angle x$ .

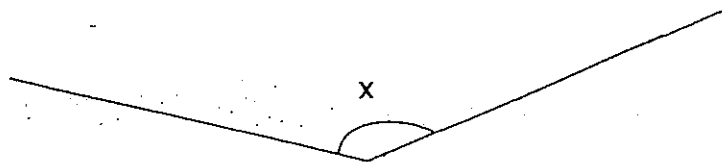

Ans : \_\_\_\_\_°

(Go on to the next page)

28. In the figure, name the two angles that are greater than  $90^\circ$ .

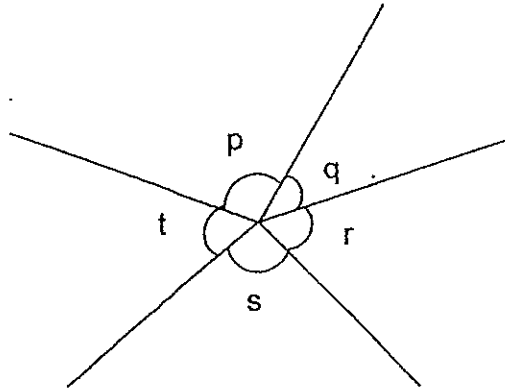

Ans : \_\_\_\_\_

Study the table below and answer questions 29 and 30.

The table shows the number of books the children had borrowed.  
A total of 50 books were borrowed by the children.

Number of books borrowed by each child	1	2	3	4	5
Number of children	4	4	5	2	?

29. How many children borrowed 3 books or less?

Ans : \_\_\_\_\_

30. How many children borrowed 5 books?

Ans : \_\_\_\_\_

(Go on to the next page)

31. Mr Kumar took a flight from Singapore at 22 30 and arrived at Hong Kong at 02 12 the next day. How long was the flight to Hong Kong?

Ans : \_\_\_\_\_ min

32. Mrs Lim took 1 hour to reach the cinema from her house. She was 20 min early for the show. The show started at 19 00.  
At what time did she leave her house? Give your answer in 24-h clock.

Ans : \_\_\_\_\_

33. The perimeter of a rectangle is 48 cm. Its length is 3 times as long as its breadth. Find its area.

Ans : \_\_\_\_\_ cm<sup>2</sup>

34. X and Y are identical squares. X overlaps Y partially as shown below.  
What is area of the shaded part?

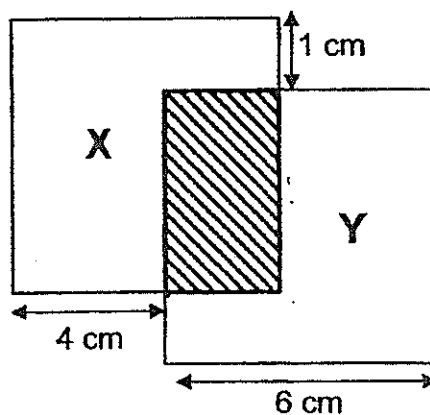

Ans : \_\_\_\_\_ cm<sup>2</sup>

(Go on to the next page)

35. Complete the drawing below by shading 2 more squares so that the dotted line is a line of symmetry.

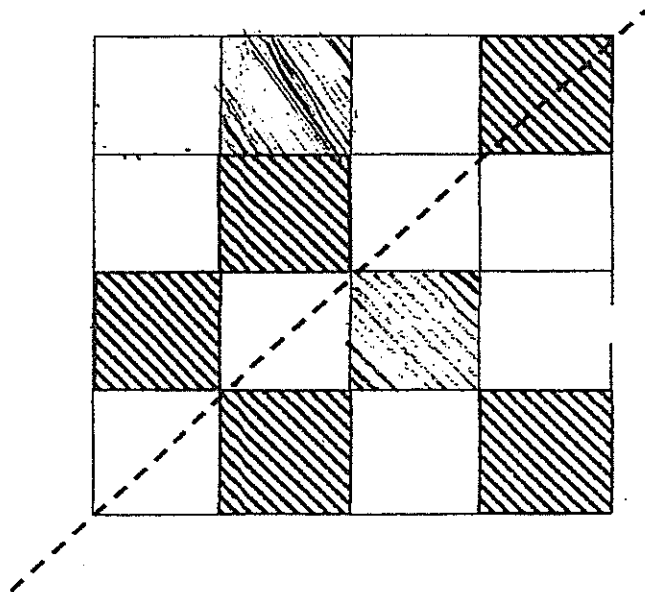

36. The pattern in the box shows part of a tessellation. Draw three more unit shapes in the space provided.

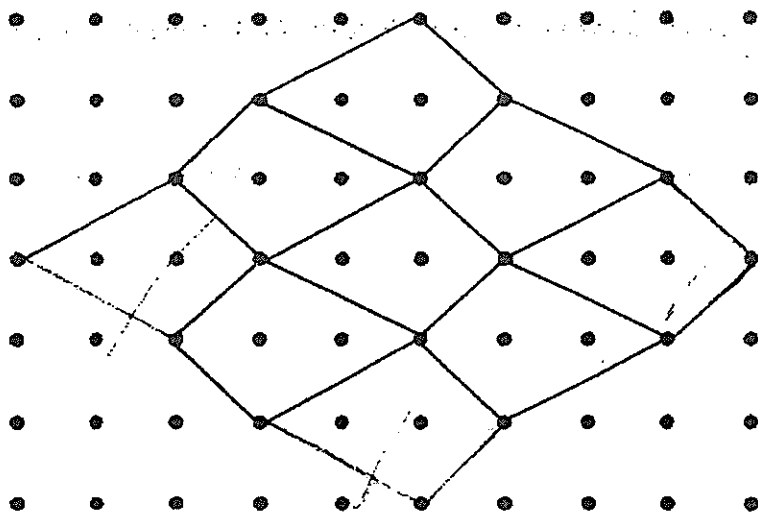

# METHODIST GIRLS' SCHOOL (PRIMARY)

Founded in 1887



## END-OF-YEAR EXAMINATION 2015 PRIMARY 4 MATHEMATICS BOOKLET C

Total Time: 1 h 45 minutes

### INSTRUCTIONS TO CANDIDATES

Do not turn over this page until you are told to do so.  
Follow all instructions carefully.  
Answer all questions.

Name: \_\_\_\_\_ ( )

Class: Primary 4. \_\_\_\_\_

Date: 28 OCTOBER 2015

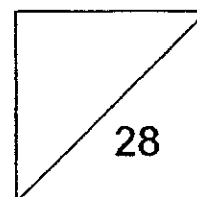

This booklet consists of 7 printed pages including this page.

**Section C: (28marks)**

Show your working clearly in the space provided for each question and write your answers in the space provided.

The number of marks available is shown in brackets [ ] at the end of each question or part-question.

37. A box of poster colours cost \$8.  
It costs twice as much as a drawing block.  
Mr Lim bought 2 boxes of poster colours and 6 drawing blocks.  
How much did Mr Lim pay?

Ans: \_\_\_\_\_ [3]

38. There were an equal number of apples and oranges at a fruit stall at first.  
After 378 apples and 121 oranges were sold, there were twice as many oranges as apples left in the stall.  
How many oranges were there in the stall at first?

Ans: \_\_\_\_\_ [3]

(Go on to the next page)



- 39 Mary had some money. She spent  $\frac{2}{5}$  of it on drinks and  $\frac{3}{10}$  of it on food .  
She had \$60 left.

- (a) What fraction of her money did Mary spend?  
(b) How much money did Mary have at first?

Ans : (a) \_\_\_\_\_ [1]

(b) \_\_\_\_\_ [2]

40. A dress and 2 similar pairs of shorts cost \$95.30. Each pair of shorts was \$6.50 cheaper than the dress. Find the cost of one pair of shorts.

Ans: \_\_\_\_\_ [3]

(Go on to the next page)

41. Halim, Garret and Clement went shopping. Halim and Garret spent a total of \$245. Halim and Clement spent \$605 altogether. Clement spent 3 times as much as Garret.
- (a) How much did Garret spend?
- (b) How much did Halim spend?

Ans: (a) \_\_\_\_\_ [2]

(b) . \_\_\_\_\_ [2]

(Go on to the next page)

42 AE is a 3 m long straight line.

$$AC = 1\frac{1}{2}\text{ m and } DE = \frac{5}{8}\text{ m. } BC = CD$$

C divides AE into equal halves.

What is the length of BE? Give your answer as a mixed number.

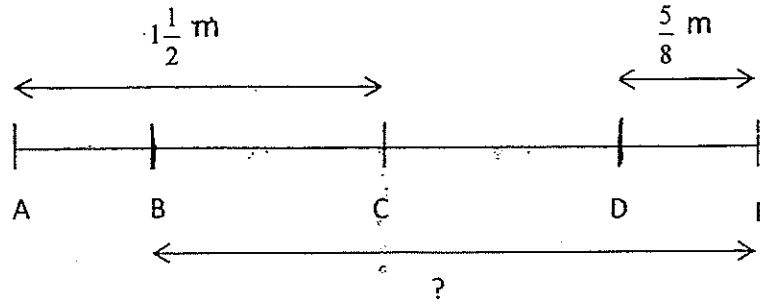

Ans: \_\_\_\_\_ [4]

(Go on to the next page)

43. Jamie had a ribbon that was 50.5 m long. She cut 13 m of it for herself and then cut the remaining ribbon equally to give to 4 of her friends.

(a) What was the total length of the ribbon given to her 4 friends?

(b) What was the length of the ribbon received by each of her friends?

Round off your answer to the nearest hundredths

Ans:(a) \_\_\_\_\_ [1]

(b) \_\_\_\_\_ [3]

(Go on to the next page)

44. The figure shows a rectangle of breadth 10 cm and 4 similar squares of side 4 cm. The area of the shaded part is  $286 \text{ cm}^2$ .
- (a) What is the length of the rectangle?
- (b) What is the perimeter of the rectangle?

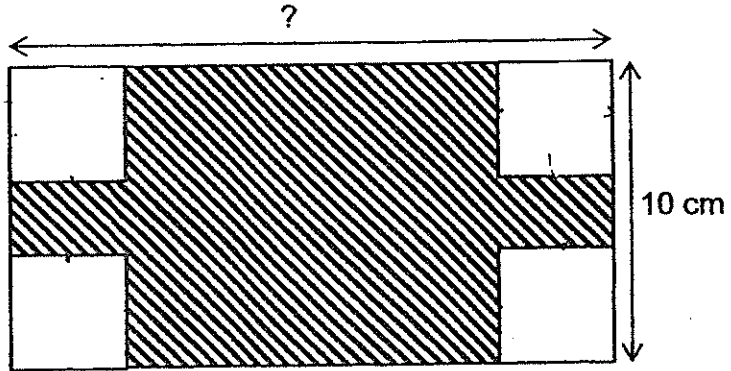

Ans: (a) \_\_\_\_\_ [2]

(b) \_\_\_\_\_ [2]



**EXAM PAPER 2015**

**LEVEL : PRIMARY 4**

**SCHOOL : METHODIST GIRLS' SCHOOL**

**SUBJECT : MATHEMATICS**

**TERM : SA2**

Q1	Q2	Q3	Q4	Q5	Q6	Q7	Q8	Q9	Q10
3	2	2	3	2	3	2	3	3	4
Q11	Q12	Q13	Q14	Q15	Q16	Q17	Q18		
2	1	4	4	4	2	1	3		

Q19. 30 200

Q20. 4,14

Q21. 6

Q22.  $\frac{5}{7}, \frac{6}{11}$

Q23.  $4\frac{1}{2}$

Q24. 0.015 ( smallest ),  $0.105, \frac{3}{20}$

Q25. 9.74

Q26. \$21.60  $\rightarrow 3.60 \times 6 = 21.60$

Q27.  $144^\circ$

Q28.  $\angle P, \angle S$

Q29. 13

Q30. 3 children

$1 \times 4 = 4, 2 \times 4 = 8, 3 \times 5 = 15, 4 \times 2 = 8, 4 + 8 = 12, 12 + 8 = 20,$   
 $20 + 15 = 35, 50 - 35 = 15, 15 \div 5 = 3$

Q31. 3h42min

Q32. 1740'

Q33.  $108\text{cm}^2$

Q34.  $10\text{cm}^2$

Q35. SEE PICTURE

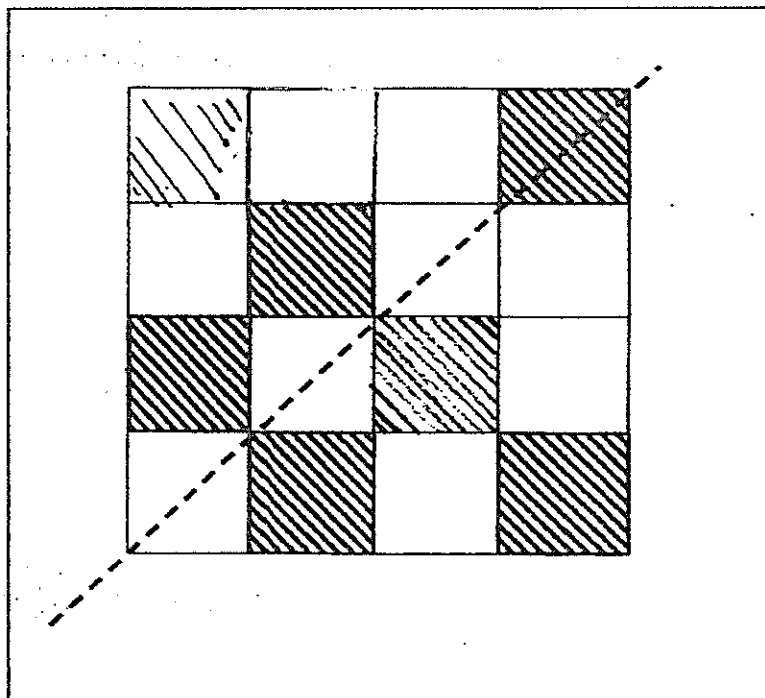

Q36. SEE PICTURE

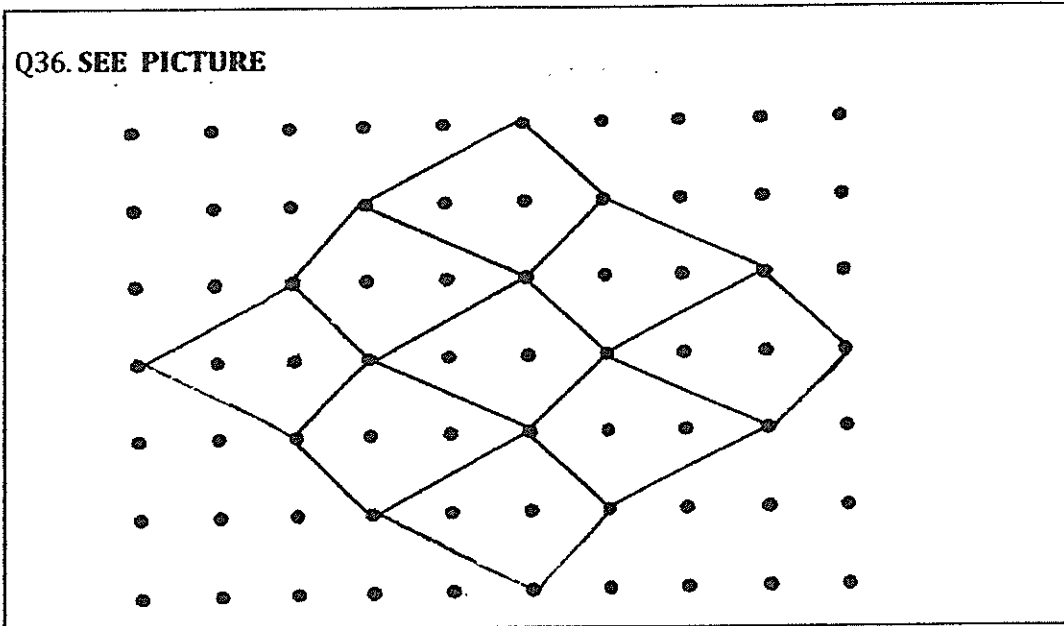

Q37. \$40 →  $8 \div 2 = 4$ ,  $4 \times 10 = 40$

Q38. 635 oranges

$$3768 - 121 = 257$$

$$1u \rightarrow 257, 257 \times 2 = 514, 514 + 121 = 635$$

$$Q39a. \frac{7}{10} \rightarrow \frac{2}{5} \times 2 = \frac{4}{10}, \frac{4}{10} + \frac{3}{10} = \frac{7}{10}$$

$$Q39b. \$200 \rightarrow 60 \div 3 = 20, 20 \times 10 = 100$$

$$Q40. \$29.60 \rightarrow 95.30 - 6.50 = 88.80, 88.80 \div 3 = 29.60$$

$$Q41a. \$180 \rightarrow 2u \rightarrow 605 - 245 = 360, 1u \rightarrow 360 \div 2 = 180$$

$$Q41b. \$65 \rightarrow 245 - 180 = 65$$

Q42.  $2\frac{3}{8}m$

$$\frac{14}{8} + \frac{5}{8} = 1\frac{2}{8} 2\frac{1}{8}, 3 - 2\frac{1}{8} = \frac{7}{8} \text{ (CD)}, \frac{7}{8} + \frac{7}{8} = \frac{14}{8}$$

$$\frac{14}{8} + \frac{5}{8} = \frac{19}{8}, \frac{19}{8} 2\frac{3}{8} \text{ (mixed number)}$$

$$Q43a. 37.5m \rightarrow 50.5 - 13 = 37.5$$

$$Q43b. 9.38m \rightarrow 37.5 \div 4 = 9.375, 9.375 \approx 9.38$$

$$Q44a. 35cm \rightarrow 4 \times 4 = 16, 16 \times 4 = 64, 64 + 286 = 350, 350 \div 10 = 35$$

$$Q44b. 90cm \rightarrow 35 + 10 = 45, 45 \times 2 = 90$$

**THE END**